

NYOrtho

CUSTOMIZING COMFORT THROUGH DESIGN AND INNOVATION

2016 CATALOG



AMBULATION • ARM SLINGS • GAIT TRANSFER BELTS • OXYGEN CYLINDER HOLDERS • SUPPORT PILLOWS & CUSHIONS • BEDSIDE SAFETY MATS • RESTRAINTS • BED SAFETY • SIDE RAIL PROTECTION • REPOSITIONING SLIDES • WHEELCHAIR ACCESSORIES • ORTHOPEDIC & REHABILITATIVE SEATING • SAFETY WEAR • WHEELCHAIR ACCESSORIES • ORTHOPEDIC & REHABILITATIVE SEATING • SEATING & POSITIONING • WOUND MANAGEMENT

NYOrtho

CUSTOMIZING COMFORT THROUGH DESIGN AND INNOVATION

Dear Customer:

NYOrtho manufactures effective safety, positioning, and pressure relief products for use in the wheelchair or bed as well as ergonomic / rehabilitative products designed to support the musculoskeletal frame. Designed for nursing homes, hospitals, rehabilitation facilities, and home care settings, our products assist doctors, nurses, and therapists in providing quality care without compromise.

As a manufacturer of standard and custom medical products, we provide medical product solutions that will improve your bottom line. Our innovative product design team combine effective design protocol with state of the art raw materials to help you design a new product or improve an existing one.

At NYOrtho, service is as important as the product we produce. Competitive pricing and timely delivery is our company promise. We maintain an extensive inventory and make every effort to ship all orders to arrive when you expect them. Our philosophy includes making sure, with each customer contact, that our reputation precedes us - a reputation for **maximum quality, dependability, concern and response**. Meeting these mission objectives means taking nothing for granted and challenging everything. We are constantly striving for continuing improvement - in our product lines, new products and services under development, and with an ever-expanding structure of professional support services.

Thank you for viewing our catalog. Your feedback is welcomed and encouraged.

We remain, your dedicated vendor.

Sincerely,

Michael Blatt
Michael Rozenberg



Wound Management 4 - 9



Seating & Positioning 10 - 23



Wheelchair / Geri-Chair Accessories 24 - 29



Patient Safety 30 - 31



Fall Management 32 - 33



Bed Accessories 34 - 37



Therapy & Ambulation 38 - 42



Orthopedic Rehabilitation 43 - 47



Occupational Safety 48 - 51

AM

ANTI-MICROBIAL

CSA

CUSTOM SIZING AVAILABLE

WP

WATER-PROOF

WR

WATER-RESISTANT

HA

HYPOALLERGENIC

PRODUCT CODING

LOOK FOR THE INFORMATIVE COLOR CODES FOR QUICK PRODUCT ATTRIBUTE IDENTIFICATION.

TC

THERMAL CONDUCTIVITY



Wound Management

Zero-G Series

Zero-G™ Series

The NYOrtho ZERO-G line of products now includes the **Zero-G Boot AIR™**, the **Zero-G Boot™**, **Zero-G Performa Boot™**, the **Zero-G Heel Pillow™** and the **Zero-G Heel Pillow Ultra™**. This series is aggressively designed to eliminate pressure and friction to the skin, creating a ZERO pressure environment, providing relief from, and preventing pressure sores.

Zero-G Boot AIR™ AM

RECOMMENDED USE: Individuals unable to avoid long periods of uninterrupted pressure over bony prominences are at increased risk for the development of necrosis and ulceration.

The **NYOrtho ZERO-G Boot AIR™** combines craftsmanship and innovation providing a lighter, low-profile, more comfortable design utilizing hi-performance spacer fabrics and foams to help eliminate pressure and friction to the skin while suspending the heel and bony prominence on both sides of the ankle.

■ Super-Soft Velvet Lining: W/Added ANTIMICROBIAL Protection

SUPER-SOFT VELVET cloth protects thin fragile skin from tears caused by trauma, reducing friction and shear.

■ Hi-Performance Spacer Fabric Provides Cool Comfort

Spacer fabric is a specialized three-dimensional textile that uniquely facilitates air flow, breathability and lightweight shape support.

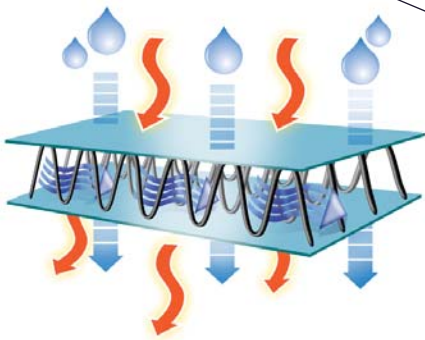

■ Heel: Zero-G Protection

Extended and cushioned design floats the heel over air cavity for ZERO pressure.

■ Malleoli: Zero-G Protection

Open-form design protects and floats lateral and medial malleoli - bony prominence on both sides of the ankle.

■ Removable Gel-Pack

A removable GEL-PACK may be utilized to further lower pressure beneath the ankle, keeping feet cool.

STANDARD SIZES

Model	Size	Fits	Width
9518AIR-S	Small	Petite Adult / Pediatric	3"
9518AIR-M	Medium	Average Adult	4"
9518AIR-L	Large	Large Adult / Bariatric	5"
FA-GEL-4x8	Replacement Gel-Pack	9518, 9518AIR, 9518P	
9518-BAG	Washing Machine Bag	9518, 9518AIR, 9518P	

■ Open Form Design

Specifically designed to promote healing via open form construction providing more air to skin surface.





ZERO-G Boot™ AM

RECOMMENDED USE: Individuals unable to avoid long periods of uninterrupted pressure over bony prominences are at increased risk for the development of necrosis and ulceration.



9518



Super-Soft Velvet Lining: W/Added ANTIMICROBIAL Protection

SUPER-SOFT VELVET cloth protects thin fragile skin from tears caused by trauma, reducing friction and shear.

Heel: Zero-G Protection

Extended and cushioned design floats the heel over air cavity for ZERO pressure.

Removable Gel-Pack

A removable GEL-PACK may be utilized to further lower pressure beneath the ankle, keeping feet cool.

STANDARD SIZES

Model	Size	Fits	Width
9518-S	Small	Petite Adult / Pediatric	3"
9518-M	Medium	Average Adult	4"
9518-L	Large	Large Adult / Bariatric	5"
FA-GEL-4x8	Replacement Gel-Pack	9518, 9518AIR, 9518P	
9518-BAG	Washing Machine Bag	9518, 9518AIR, 9518P	

ZERO-G Performa Boot™ AM WR

RECOMMENDED USE: Individuals unable to avoid long periods of uninterrupted pressure over bony prominences are at increased risk for the development of necrosis and ulceration.



9518P

• Heel: Zero-G Protection

Extended and cushioned design floats the heel over air cavity for ZERO pressure.

• Performance Cover: W/Added ANTIMICROBIAL Protection

High performance pressure reducing fabric promotes healing via active evaporation of moisture and cooling at patient pressure points.

• Removable Gel-Pack

A removable GEL-PACK may be utilized to further lower pressure beneath the ankle, keeping feet cool.

STANDARD SIZES

Model	Size	Fits	Width
9518P-S	Small	Petite Adult / Pediatric	3"
9518P-M	Medium	Average Adult	4"
9518P-L	Large	Large Adult / Bariatric	5"
FA-GEL-4x8	Replacement Gel-Pack	9518, 9518AIR, 9518P	
9518-BAG	Washing Machine Bag	9518, 9518AIR, 9518P	



Wound Management
Zero-G Series

Zero-G Heel Pillow Ultra™ AM WR

RECOMMENDED USE: Individuals unable to avoid long periods of uninterrupted pressure over bony prominences are at increased risk for the development of necrosis and ulceration.

The **NYOrtho ZERO-G Heel Pillow ULTRA™** transforms everyday therapy providing exceptional support and comfort with a new contoured design that conforms to the body's natural position while off-loading the heel into the air. The **ULTRA™** provides a more relaxing and restful experience promoting patient position, thereby preventing, and providing relief from pressure sores.



9902

- New **ULTRA™** design provides increased comfort and rest while preserving patient position
- Cushioned design off-loads heels into air, preventing and providing relief from pressure sores
- Can be positioned in either direction to maintain slightly lifted or lowered position of the heel while providing abduction
- Convoluted surface securely and comfortably positions both legs, relaxing the spine and decreasing lower back pain
- Breathable, low-shear, stretch cover with antimicrobial protection reduces friction
- Available in a single-leg version Model 9901
- Slip resistant bottom prevents sliding
- Wipes clean for convenient care
- Meets CA 117-2013 standards

STANDARD SIZES

Model	Size	Type
9901	12" x 17" x 4¾" x 3½"	Single Leg
9902	24" x 17" x 4¾" x 3½"	Both Legs



9902



9901



9900

ZERO-G Heel Pillow™ AM WR

RECOMMENDED USE: Individuals unable to avoid long periods of uninterrupted pressure over bony prominences are at increased risk for the development of necrosis and ulceration.

- Cushioned design off-loads heels into air, preventing and providing relief from pressure sores
- Convoluted surface securely and comfortably positions both legs, relaxing the spine and decreasing lower back pain
- Breathable, low-shear, stretch cover with antimicrobial protection reduces friction
- Slip resistant bottom prevents sliding
- Wipes clean for convenient care
- Meets CA 117-2013 standards

STANDARD SIZES

Model	Size
9900	24" x 16" x 7" x 5½"

Quilted Heel and Elbow Protectors provide comfort and protection to sensitive skin, reducing pressure and increasing blood flow to the affected area. A soft and fluffy spun fiber-fill helps provide extra comfort and protection. Padded hook & loop closure allows for easy application and removal. Machine washable. Meets CA 117-2013 standards.



Wound Management Heel Protectors



9510

Quilted Heel Protector WR WR

RECOMMENDED USE: Patients at risk for skin breakdown and friction burns.

- Breathable, **WATER-RESISTANT** taslon fabric helps promote air circulation and wicks moisture away

STANDARD SIZES

Model	Size	Dimensions	Unit
9510	Standard	9" x 10"	Pair
9510L	Bariatric	11" x 11½"	Pair



9511

Quilted Heel Protector Plaid

RECOMMENDED USE: Patients at risk for skin breakdown and friction burns.

- Cotton/polyester fabric minimizes the risk of friction and shear

STANDARD SIZES

Model	Size	Dimensions	Unit
9511	Standard	9" x 10"	Pair
9511L	Bariatric	11" x 11½"	Pair



9514

Super Quilted Heel Protector AM WR

RECOMMENDED USE: Patients at risk for skin breakdown and friction burns.

- Designed with **SUPER FLUFFY**, spun fiber-fill for enhanced comfort and protection
- Breathable, **WATER-RESISTANT** peachskin fabric helps promote air circulation and wicks moisture away
- ANTIMICROBIAL** - No odor no bacteria: Thanks to the built-in hygiene function
- A removable gel-pack may be utilized to further lower pressure beneath the heel
- Soft foam closure with easy hook & loop application

STANDARD SIZES

Model	W/Gel-Pack	Size	Dimensions	Unit
9514	9514-GP	Standard	10" x 10½"	Pair
9514L	9514L-GP	Bariatric	11" x 11½"	Pair



Wound Management

Heel/Elbow Protectors

BEDSORE PREVENTION

Bedsore prevention is easier to prevent than to treat, but that doesn't mean the process is easy or uncomplicated. And wounds may still develop with consistent, appropriate preventive care. Your doctor and other members of the care team can help develop a good strategy, whether it's personal care with at-home assistance, professional care in a hospital or some other situation.

Position changes are key to preventing pressure sores. These changes need to be frequent, repositioning needs to avoid stress on the skin, and body positions need to minimize pressure on vulnerable areas. Other strategies include taking good care of your skin, maintaining good nutrition, quitting smoking and exercising daily.

Mayo Clinic Staff www.mayoclinic.org



9516

Ultra Quilted Heel Protector AM

RECOMMENDED USE: Patients at risk for skin breakdown and friction burns.

- **ULTRA-SOFT** velvet fabric is gentle on the skin
- **ANTIMICROBIAL** - No odor no bacteria: Thanks to the built-in hygiene function

STANDARD SIZES

Model	Size	Dimensions	Unit
9516	Standard	9" x 10"	Pair
9516L	Bariatric	11" x 11½"	Pair



9515

Quilted Heel & Calf Protector AM WR

RECOMMENDED USE: Patients at risk for skin breakdown and friction burns.

- Designed with **EXTRA FLUFFY**, spun fiber-fill for enhanced comfort and protection
- Breathable, **WATER-RESISTANT** peachskin fabric helps promote air circulation and wicks moisture away
- **ANTIMICROBIAL** - No odor no bacteria: Thanks to the built-in hygiene function

STANDARD SIZES

Model	Size	Dimensions	Unit
9515	Universal	14" x 9"	Pair



9360

Quilted Elbow Protector WR

RECOMMENDED USE: Patients at risk for skin breakdown and friction burns.

- Breathable, **WATER-RESISTANT** taslon fabric helps promote air circulation and wicks moisture away

STANDARD SIZES

Model	Size	Unit
9360	Universal	Pair



NYOrtho Derma Shield™ AM

RECOMMENDED USE: Patients with fragile skin; to protect IV / wound sites and to protect skin from tears and abrasions.

Helps Protect Fragile Skin

Derma Shield™ protective arm and leg sleeves are a non-compression skin covering suitable for a variety of applications. They help provide a protective barrier against tears and abrasions for fragile skin tissue. The **anti-microbial**, soft 4-way stretch covering is latex-free and adapts to different body shapes. Protective Derma Shield™ can also help prevent patient disruption of medical treatments by camouflaging both IV sites and wound sites by blending in with the patient's skin tone.

Features an easy to identify size reference - number of bands indicate size. Color: light skin tone. 1 pair per package.

STANDARD SIZES

Model	Type	Size	Length	Circumference	No. of Size Bands	Unit
9402-S	Arm	Small	15½"	8½"	1	Pair
9402-M	Arm	Medium	16½"	11"	2	Pair
9402-L	Arm	Large	18"	11"	3	Pair
9402-XL	Arm	XL	20"	13"	4	Pair
9100-U	Leg	Universal	13½"	11"	N/A	Pair

Derma Shield™ are intended to fit comfortably. Actual fit will depend on individual measurements and patient comfort level. NYOrtho Derma Shield™ will stretch up to 100% in size of both width and length.



9402



9509-B

Economy Sheepskin Protectors

RECOMMENDED USE: Patients at low risk of skin breakdown and friction burns.

NYOrtho Sheepskin Protectors are made from synthetic fur and help provide comfort and warmth for patients with sensitive skin.

- Non-allergenic, flame retardant, imitation sheepskin
- Comfortably secured with hook & loop closure
- One size fits all
- Machine washable
- Meets CA 117-2013 standards



9509-A



9517

STANDARD SIZES

Model	Description	Size	Unit
9509-A	Heel Protector	Universal	Pair
9509-B	Elbow Protector	Universal	Pair
9517	Sheepskin Boot	Universal	Pair



Seating & Positioning Cushions

APEX™ Series AM WR CSA

The APEX™ Gel-Cushion features an innovative design that chambers the gel-pod closer to the top of the cushion providing a cooler interface between the patient and wheelchair. This direct interface is available in a dual or quad gel-pod chamber that evenly maintains gel in the area of highest pressure, preventing skin breakdown and maintaining a cool surface temperature. A high-performance, stretch cover improves moisture evaporation, enhancing APEX™ design features. Available with a firm core foundation that eliminates hammocking.

Innovative APEX™ Design Cools and Reduces Body Interface Pressure

Dual density foam layers provides a soft top entry layer promoting direct interface with cooling gel-pod and a higher density base layer for support and pressure distribution. This top-design brings the gel-pod up close so you can feel the superior comfort and stability.

Aqueous Chambered Gel-Pod

Chambered gel-pod reduces gel migration and dissipates metabolic heat, continuously maintaining a cool interface between the body and cushion.



Breathable Stretch Removable Cover

High performance pressure reducing fabric promotes healing via active evaporation of moisture and cooling at patient pressure points.

Easy-To-Attach Quick-Release Straps

Conveniently attaches cushion to wheelchair frame.

Anti-Microbial, Mildew Resistant, Flame Retardant & Water-Resistant

Maintains cleanliness and safety. CA 117-2013

APEX™ Anti-Thrust Foam Cushion APEX™ Anti-Thrust Gel-Foam Cushion

RECOMMENDED USE: Patients at risk for pressure ulcers, requiring anterior buildup at mid-line while preventing forward ischial migrations.

STANDARD SIZES

Size	Foam	Gel-Foam
18" x 16" x 4" x 2"	9597-ATH-181642	9597-ATG-181642
20" x 16" x 4" x 2"	9597-ATH-201642	9597-ATG-201642



9597-ATH, 9597-ATG

THE SCIENCE

Adapted from Martin W. Ferguson-Pell, PhD

Why do wheelchair cushions help prevent pressure sores?

Bone resists even large forces with barely perceptible deformation. Muscle and fat are far more vulnerable because they deform more readily, causing blood vessels to be occluded. The force due to body weight, when sitting, is imposed by the ITs on the gluteal muscles and fat, which become deformed due to the compressive force. In addition to the force of the ITs and the amount of tissue supporting them, tissue stiffness or tone also determines how much deformation (and therefore damage potential) is developed in the fat and muscle. Wheelchair users with little muscle tone in their gluteal area are less able to resist tissue deformation, and are therefore more vulnerable to discomfort and tissue damage. If weight-bearing can be shared equally by the ITs and the nearby lateral posterior spect of the trochanters, the force at each IT is half of that when only the ITs are loaded, and more soft tissues can share the burden. Weight distribution is, therefore, an important principle used for designing cushions that are shaped to encourage trochanteric and thigh support

THE SCIENCE CONT.

Is it important to use a breathable cover?

Moisture accumulation can occur if materials in close contact with the skin do not “breathe.” Vapor-impermeable covers prevent moisture-laden air from being diluted by drier air, thereby preventing newly-formed sweat from evaporating or being absorbed. Furthermore, because sweat is not being evaporated, natural environmental cooling cannot occur, resulting in more heat build-up and more sweating.

Methods for preventing moisture build-up include the use of cushion and cover materials that encourage air exchange between the cushion and skin. Cushions with good heat dissipation characteristics help to reduce moisture build-up, if they are appropriately covered with absorbent materials. However, in many cases, the use of an impermeable cover is necessary when a resident is incontinent.

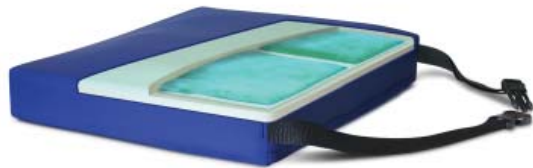

APEX™ Foam Cushion

RECOMMENDED USE: Patients at risk for pressure ulcers

STANDARD SIZES

Higher Density Foam

Size	Model
16" x 16" x 2"	9597-161602
16" x 16" x 3"	9597-161603
18" x 16" x 2"	9597-181602
18" x 16" x 3"	9597-181603
20" x 18" x 3"	9597-201803
22" x 18" x 2"	9597-221802

APEX™ Gel-Foam Cushion

RECOMMENDED USE: Patients at risk for pressure ulcers

STANDARD SIZES

Size	2 Inch Height	3 Inch Height
16" x 16"	9597-GEL-161602	9597-GEL-161603
18" x 16"	9597-GEL-181602	9597-GEL-181603
18" x 18"	9597-GEL-181802	9597-GEL-181803
20" x 16"	9597-GEL-201602	9597-GEL-201603
20" x 18"	9597-GEL-201802	9597-GEL-201803
22" x 18"	9597-GEL-221802	9597-GEL-221803
24" x 18"	9597-GEL-241802	9597-GEL-241803

APEX™ Bariatric Foam Cushion APEX™ Bariatric Gel-Foam Cushion

RECOMMENDED USE: Patients at risk for pressure ulcers.

- Features a specially formulated bariatric density foam

BARIATRIC SIZES

Size	Gel
24" x 18" x 3"	9597B-GEL-241803
24" x 20" x 3"	9597B-GEL-242003
24" x 20" x 4"	9597B-GEL-242004
26" x 18" x 3"	9597B-GEL-261803
26" x 18" x 4"	9597B-GEL-261804
28" x 18" x 3"	9597B-GEL-281803
30" x 19" x 3"	9597B-GEL-301903

BARIATRIC SIZES

Size	Foam
22" x 18" x 3"	9597B-221803
24" x 18" x 3"	9597B-241803
26" x 18" x 3"	9597B-261803



APEX™ Quad Gel-Foam Cushion

RECOMMENDED USE: Patients at risk for pressure ulcers.

STANDARD SIZES

Size	2 Inch Height	3 Inch Height
16" x 16"	9597-4GEL-161602	9597-4GEL-161603
18" x 16"	9597-4GEL-181602	9597-4GEL-181603
20" x 16"	9597-4GEL-201602	9597-4GEL-201603
20" x 18"	9597-4GEL-201802	9597-4GEL-201803
22" x 18"	9597-4GEL-221802	9597-4GEL-221803

APEX™ Bariatric Quad Gel-Foam Cushion

RECOMMENDED USE: Patients at risk for pressure ulcers.

- Features a specially formulated bariatric density foam

BARIATRIC SIZES

Size	4-Gel
24" x 18" x 4"	9597B-4GEL-241804
26" x 20" x 3"	9597B-4GEL-262003
30" x 18" x 3"	9597B-4GEL-301803
30" x 22" x 3"	9597B-4GEL-302203

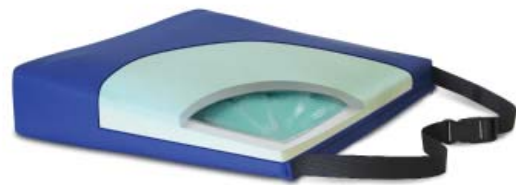

APEX™ Wedge Foam Cushion APEX™ Wedge Gel-Foam Cushion

RECOMMENDED USE: Patients at risk for pressure ulcers, requiring posture support and/or inclined to slide forward.

STANDARD SIZES

Size	Foam	Gel
16" x 16" x 4" x 2"	9597-W-161642	9597-WGL-161642
18" x 16" x 4" x 2"	9597-W-181642	9597-WGL-181642
18" x 18" x 4" x 2"	9597-W-181842	9597-WGL-181842
20" x 16" x 4" x 2"	9597-W-201642	9597-WGL-201642
20" x 18" x 4" x 2"	9597-W-201842	9597-WGL-201842



Seating & Positioning Cushions

APEX™ AM WR CSA

THE SCIENCE

How does a gel cushion keep the surface area cool and comfortable?

Foam is a poor conductor of heat and has a low heat capacity. A thin layer of foam (plus cover) warms up to skin temperature when one sits on it, but does not draw much heat from the body's tissues. In warm environments, or during physical exercise, the body attempts to lose heat but is prevented from doing so in the buttocks area due to the insulating foam of the cushion. This region may therefore begin to heat, resulting in uncomfortable dampness. On the other hand, gels and fluid-filled cushions are moderate conductors of heat and have a high heat capacity. They drain heat from the buttocks and continue to do so for a long time. For energetic wheelchair users, the thermal properties of the gel help to dissipate metabolic heat. Gel cushions are also beneficial in warm environments if effective water vapor and sweat removal can be assured.

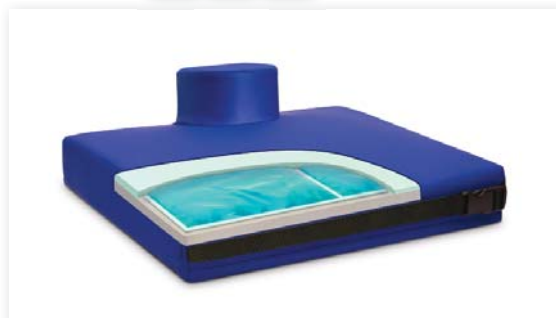

9597-GP

APEX™ Pommel Gel-Foam Cushion

RECOMMENDED USE: Patients at risk for pressure ulcers, requiring hip positioning.

STANDARD SIZES

Size	Model	Size	Model
16" x 16" x 3"	9597-GP-161603	22" x 20" x 3"	9597-GP-222003
18" x 16" x 3"	9597-GP-181603	24" x 18" x 3"	9597-GP-241803
18" x 18" x 3"	9597-GP-181803	24" x 20" x 3"	9597-GP-242003

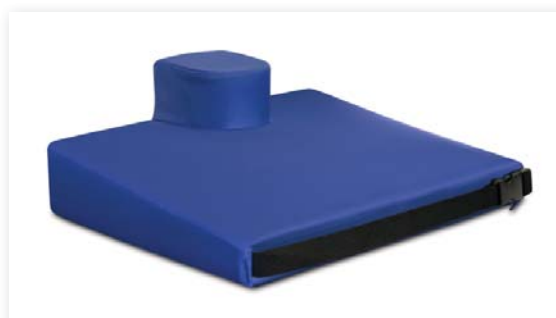

9597-GWP, 9597-WP

APEX™ Wedge Pommel Gel-Foam Cushion

RECOMMENDED USE: Patients at risk for pressure ulcers, requiring posture support and/or hip positioning that are inclined to slide forward.

STANDARD SIZES

Size	Model
18" x 16" x 4" x 2"	9597-GWP-181642



9597-GC

APEX™ Coccyx Gel-Foam Cushion

RECOMMENDED USE: Patients at risk for pressure ulcers in the coccyx area.

STANDARD SIZES

Size	Model
16" x 16" x 3"	9597-GC-161603
18" x 16" x 3"	9597-GC-181603
20" x 16" x 3"	9597-GC-201603



9597-GLC

APEX™ Waveform Gel-Foam Cushion

RECOMMENDED USE: Patients at risk for pressure ulcers, requiring posture support and/or hip positioning.

STANDARD SIZES

Size	2 Inch	3 Inch
18" x 16"	9597-GLC-181602	9597-GLC-181603
20" x 16"	9597-GLC-201602	9597-GLC-201603
22" x 16"	9597-GLC-221602	9597-GLC-221603

- Raised front controls forward thrust to maintain pelvic neutrality
- Elevated sides promote lateral stability
- Memory foam topper

Firm Core Foundation

High density beveled polyethylene provides a firm foundation that eliminates hammocking.

Innovative APEX™ Design Cools and Reduces Body Interface Pressure

Dual density foam layers provides a soft top entry layer promoting direct interface with cooling gel-pod and a higher density base layer for support and pressure distribution. This top-design brings the gel-pod up close so you can feel the superior comfort and stability.

Easy-To-Attach Quick-Release Straps

Conveniently attaches cushion to wheelchair frame.

Breathable Stretch Removable Cover

High performance pressure reducing fabric promotes healing via active evaporation of moisture and cooling at patient pressure points.

Anti-Microbial, Mildew Resistant, Flame Retardant & Water-Resistant

Maintains cleanliness and safety. CA 117-2013

Aqueous Chambered Gel-Pod

Chambered gel-pod reduces gel migration and dissipates metabolic heat, continuously maintaining a cool interface between the body and cushion.

APEX CORE™ Gel-Foam Cushion

RECOMMENDED USE: Patients at risk for pressure ulcers.

STANDARD SIZES

Size	Model	Size	Model
18" x 16" x 3"	9599-G-181603	24" x 16" x 3"	9599-G-241603
20" x 16" x 3"	9599-G-201603	24" x 18" x 3"	9599-G-241803
20" x 18" x 3"	9599-G-201803	26" x 18" x 3"	9599-G-261803
22" x 16" x 3"	9599-G-221603	28" x 18" x 3"	9599-G-281803
22" x 18" x 3"	9599-G-221803	30" x 18" x 3"	9599-G-301803



9599-G

APEX CORE™ Wedge Foam Cushion
APEX CORE™ Wedge Gel-Foam Cushion

RECOMMENDED USE: Patients at risk for pressure ulcers, requiring posture support, that are inclined to slide forward.

STANDARD SIZES

Size	Foam	Gel
16" x 16" x 4" x 2"	9599-W-161642	9599-GW-161642
18" x 16" x 4" x 2"	9599-W-181642	9599-GW-181642
20" x 16" x 4" x 2"	9599-W-201642	9599-GW-201642



9599-GW

APEX CORE™ Wedge Pommel Gel-Foam Cushion

RECOMMENDED USE: Patients at risk for pressure ulcers, requiring posture support and/or hip positioning that are inclined to slide forward.

STANDARD SIZES

Size	Model
16" x 16" x 4" x 2"	9599-GWP-161642
18" x 16" x 4" x 2"	9599-GWP-181642
20" x 16" x 4" x 2"	9599-GWP-201642
22" x 16" x 4" x 2"	9599-GWP-221642
22" x 18" x 4" x 2"	9599-GWP-221842

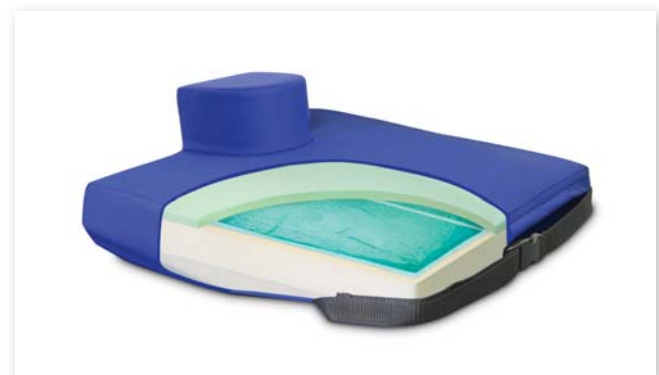

9599-GWP



Seating & Positioning Cushions

DO WE MANUFACTURE CUSTOM SIZES? **WE CERTAINLY DO!**

We can manufacture any size cushion you need. We understand your customers' needs. Doctors, nurses and therapists are always tinkering with foam to make the necessary adjustments to a cushion to fit the specific needs of each patient. They often wish that the manufacturer could make them a cushion just the way they want it. Our designers are ready to help. There are many different directions a custom product can take. Different covers can be applied to different cushions. Inner foam densities can be selected to your specifications and shapes can be modified to provide an improved product that provides the optimum rehabilitation objective for your patient. Anything you need we will do it with minimal lead time.

APEX CORE™

AM WR CSA



9599-GP

APEX CORE™ Pommel Gel-Foam Cushion

RECOMMENDED USE: Patients at risk for pressure ulcers, requiring hip positioning.

STANDARD SIZES

Size	Model	Size	Model
16" x 16" x 3"	9599-GP-161603	20" x 16" x 3"	9599-GP-201603
18" x 16" x 3"	9599-GP-181603	20" x 18" x 3"	9599-GP-201803
18" x 18" x 3"	9599-GP-181803	22" x 16" x 3"	9599-GP-221603



9599-GC

APEX CORE™ Coccyx Gel-Foam Cushion

RECOMMENDED USE: Patients at risk for pressure ulcers in the coccyx area.

STANDARD SIZES

Size	Model	Size	Model
16" x 16" x 3"	9599-GC-161603	20" x 18" x 3"	9599-GC-201803
18" x 16" x 3"	9599-GC-181603	22" x 16" x 3"	9599-GC-221603
18" x 18" x 3"	9599-GC-181803	22" x 18" x 3"	9599-GC-221803
20" x 16" x 3"	9599-GC-201603		



9599-GCP

APEX CORE™ Coccyx Pommel Gel-Foam Cushion

RECOMMENDED USE: Patients at risk for pressure ulcers in the coccyx area, requiring hip positioning.

STANDARD SIZES

Size	Model
18" x 16" x 3"	9599-GCP-181603
20" x 16" x 3"	9599-GCP-201603
22" x 16" x 3"	9599-GCP-221603
22" x 18" x 3"	9599-GCP-221803



9599-AGL

APEX CORE™ Leg Abductor Gel-Foam Cushion

RECOMMENDED USE: Patients at risk for pressure ulcers, requiring posture support and/or with abduction contracture.

STANDARD SIZES

Size	Model
18" x 16" x 3"	9599-AGL-181603

APEX CORE™ Anti-Thrust Foam Cushion APEX CORE™ Anti-Thrust Gel-Foam Cushion

RECOMMENDED USE: Patients at risk for pressure ulcers, requiring anterior buildup at mid-line while preventing forward ischial migrations.



Seating &
Positioning
Cushions



9599-ATG / 9599-ATH

STANDARD SIZES

Size	Gel	Foam
18" x 16" x 4" x 2"	9599-ATG-181642	9599-ATH-181642
20" x 16" x 4" x 2"	9599-ATG-201642	9599-ATH-201642

APEX CORE™ Gel-Infused Memory Foam Cushion

RECOMMENDED USE: Patients at risk for pressure ulcers.

Gel-infused memory foam is a 3rd generation memory foam product introduced to reduce the heat retention of standard memory foam. Gel visco or gel-infused memory foam consists of gel particles fused with visco foam to reduce trapped body heat, speed up spring back time and help the cushion feel softer.

STANDARD SIZES

Size	Model
18" x 16" x 3"	9599-GIM-181603

Gel-Infused Memory Foam

Thermal gel properties help dissipate metabolic heat.

Anti-Microbial, Mildew Resistant, Water Resistant & Flame Retardant

Maintains cleanliness and safety. CA 117-2013

Breathable Stretch Removable Cover

High performance pressure reducing fabric promotes healing via active evaporation of moisture and cooling at patient pressure points.

High Density Foam

High density stabilizing foam provides support and comfort.

Firm Core Foundation

High density beveled polyethylene provides a firm foundation that eliminates hammocking.

Easy-To-Attach Quick-Release Straps

Conveniently attaches cushion to wheelchair frame.

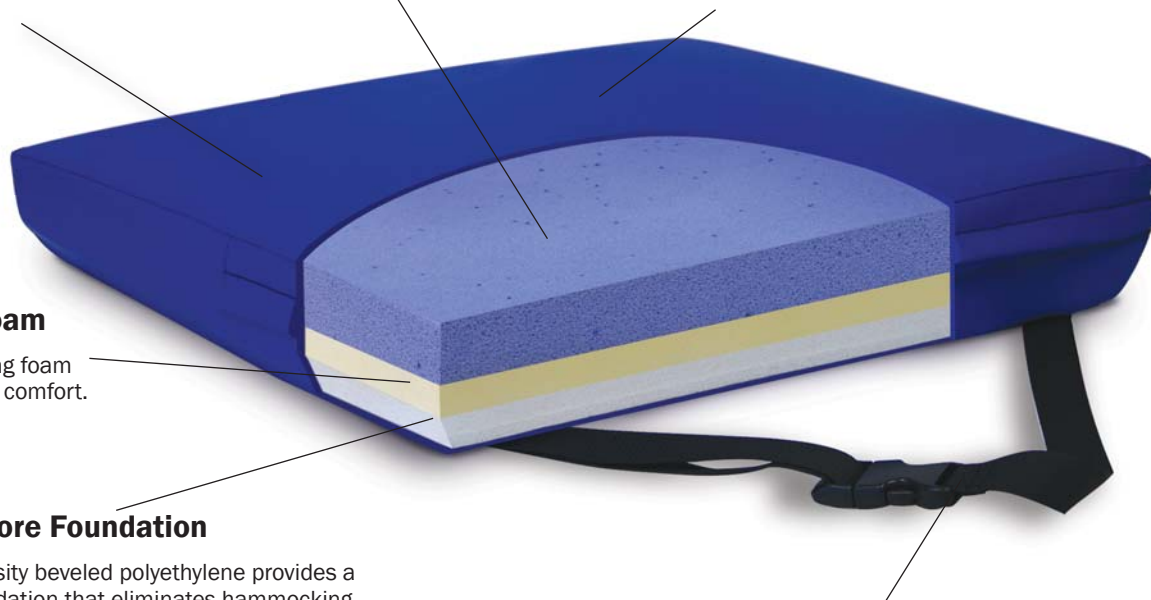



Seating & Positioning Cushions

NYOrtho Cushions

NYOrtho Cushions provide the support to enhance resident comfort and reduce excess pressure, thereby preventing skin breakdown. The 9595 series features a low-shear, fluid-proof, cover that is anti-microbial / mildew-resistant enhanced and flame retardant. A combined dual chambered gel insert within a high density foam body helps prevent pressure ulcers, improves patient comfort and correct patient positioning. Slip resistant bottom and quick-release straps secure cushion in place. Meet CA 117-2013 standards.



NYOrtho Foam Cushions

WP CSA

NYOrtho Gel-Foam Cushions

WP CSA



NYOrtho Foam Cushion

RECOMMENDED USE: Patients at low risk for pressure ulcers.

STANDARD SIZES

Size	2 Inch	3 Inch
16" x 16"	9595-161602	9595-161603
18" x 16"	9595-181602	9595-181603
20" x 16"	9595-201602	9595-201603
20" x 18"	9595-201802	9595-201803
22" x 16"	9595-221602	9595-221603
22" x 18"	9595-221802	9595-221803
24" x 18"	9595-241802	9595-241803
28" x 18"	9595-281802	9595-281803

BARIATRIC SIZES

Size	Model
22" x 18" x 4"	9595B-221804
22" x 20" x 4"	9595B-222004
30" x 20" x 3"	9595B-302003

Bariatric Density Foam

NYOrtho Gel-Foam Cushion

RECOMMENDED USE: Patients at risk for pressure ulcers.

STANDARD SIZES

Size	2 Inch	3 Inch
16" x 16"	9595-GEL-161602	9595-GEL-161603
18" x 16"	9595-GEL-181602	9595-GEL-181603
20" x 16"	9595-GEL-201602	9595-GEL-201603
20" x 18"	9595-GEL-201802	9595-GEL-201803
22" x 16"	9595-GEL-221602	9595-GEL-221603
22" x 18"	9595-GEL-221802	9595-GEL-221803
24" x 18"	9595-GEL-241802	9595-GEL-241803

NYOrtho Bariatric Gel-Foam Cushion

RECOMMENDED USE: Patients at risk for pressure ulcers. Designed to address the needs of the bariatric resident.

STANDARD SIZES

Size	3-Inch	4-Inch
20" x 18"	9595B-GEL-201803	9595B-GEL-201804
24" x 18"	9595B-GEL-241803	9595B-GEL-241804
26" x 18"	9595B-GEL-261803	9595B-GEL-261804
28" x 18"	9595B-GEL-281803	9595B-GEL-281804
30" x 18"	9595B-GEL-301803	9595B-GEL-301804
30" x 20"	9595B-GEL-302003	9595B-GEL-302004

Bariatric Density Foam



NYOrtho Wedge Foam Cushion NYOrtho Wedge Gel-Foam Cushion

RECOMMENDED USE: Patients at low risk for pressure ulcers, requiring posture support, that are inclined to slide forward.

STANDARD SIZES

Size	Foam	Gel
16" x 16" x 4" x 2"	9595-W-161642	9595-WGL-161642
18" x 16" x 4" x 2"	9595-W-181642	9595-WGL-181642
20" x 16" x 4" x 2"	9595-W-201642	9595-WGL-201642
20" x 18" x 4" x 2"	9595-W-201842	9595-WGL-201842
22" x 16" x 4" x 2"	9595-W-221642	9595-WGL-221642
22" x 18" x 4" x 2"	9595-W-221842	9595-WGL-221842



NYOrtho Independent Cell Foam Cushion

RECOMMENDED USE: Patients at risk for pressure ulcers. Independent cell foam adapts and provides pressure relief where needed

STANDARD SIZES

Size	Model
18" x 16" x 3"	9595-IC-181603
18" x 18" x 3"	9595-IC-181803
20" x 16" x 3"	9595-IC-201603

Highest Industry Standards / Made in the USA!

- Antimicrobial / mildew-resistant enhanced
- Low-shear, fluid-proof, flame retardant cover
- 4lbs. dual-chambered gel insert
- High density foam body
- Slip resistant bottom
- Quick-release straps



Seating &
Positioning
Cushions



NYOrtho Pommel Foam Cushion NYOrtho Pommel Gel-Foam Cushion

RECOMMENDED USE: Patients at low risk for pressure ulcers, requiring hip positioning.

STANDARD SIZES

Size	Foam	Gel
16" x 16" x 2"	9595-P-161602	9595-GP-161602
16" x 16" x 3"	9595-P-161603	9595-GP-161603
18" x 16" x 2"	9595-P-181602	9595-GP-181602
18" x 16" x 3"	9595-P-181603	9595-GP-181603
18" x 18" x 3"	9595-P-181803	9595-GP-181803
20" x 16" x 3"	9595-P-201603	9595-GP-201603
20" x 18" x 2"	9595-P-201802	9595-GP-201802
20" x 18" x 3"	9595-P-201803	9595-GP-201803



NYOrtho Convoluted Gel-Foam Cushion

RECOMMENDED USE: Patients at risk for pressure ulcers.

STANDARD SIZES

Size	Model
16" x 16" x 3"	9595-CGL-161603
18" x 16" x 3"	9595-CGL-181603
20" x 18" x 3"	9595-CGL-201803



NYOrtho Wedge Pommel Foam Cushion NYOrtho Wedge Pommel Gel-Foam Cushion

RECOMMENDED USE: Patients at risk for pressure ulcers, requiring posture support and/or hip positioning that are inclined to slide forward.

STANDARD SIZES

Size	Foam	Gel
16" x 16" x 4" x 2"	9595-WP-161642	9595-GWP-161642
18" x 16" x 4" x 2"	9595-WP-181642	9595-GWP-181642

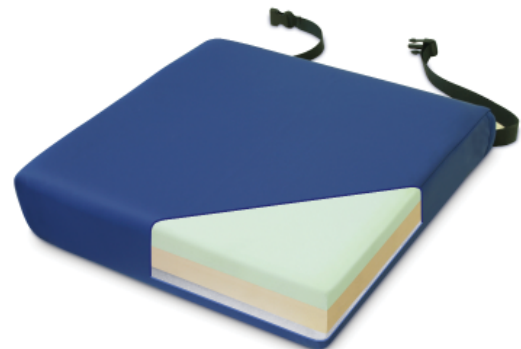

NYOrtho Tri-Foam Cushion

RECOMMENDED USE: Patients at risk for pressure ulcers.

STANDARD SIZES

Size	Model
18" x 16" x 4"	9595-TRI-181604



Sure-Chek™ Fabric Wheelchair Cushion Covers

AM WP HA TC CSA

RECOMMENDED USE: Incontinent patients at risk for pressure ulcers.

MODEL XXXX-XX-XXXX-SC

- **FLAME RESISTANT:** All **Sure-Chek** healthcare fabrics are flame resistant and self-extinguish when a source flame is removed.
- **ANTIMICROBIAL FABRIC PROTECTION:** The antimicrobial agent helps protect the fabric from microbial attack and reduces undesirable organic odors.
- **THERMAL CONDUCTIVITY:** **Sure-Chek** healthcare fabrics all perform within a desirable range for patient comfort without sacrificing important technical performance benefits.
- **FLUID PROOF & MOISTURE VAPOR TRANSMISSION:** All **Sure-Chek** healthcare fabrics are fluid and moisture proof, reducing the risk of contamination of the mattress from liquids or bodily fluids.
- **HYPOALLERGENIC:** **Sure-Chek** healthcare fabrics have been engineered to be hypoallergenic and comfortable for the user.



Simply order the cushion of your choice and add the suffix **SC** to the model number and we will provide you with your favorite cushion in a **Sure-Chek** cover.

Rotational Cover Fluid-Resistant

Super soft **PEACHSKIN** fabric is strong, durable, antimicrobial, and fluid resistant - improves moisture evaporation. CA 117-2013

Sure-Chek Peachskin Rotational Cover Gel-Foam Cushion

AM WP WR CSA

RECOMMENDED USE: Patients at risk for pressure ulcers.



Rotational Cover Fluid-Proof

SURE-CHEK™ thermoplastic fabric composites are strong, durable, antimicrobial, anti-static, flame resistant, stain, odor, and fluid proof.

SURE-CHEK™ Approved Disinfectants: When used in accordance with mfg. recommendation: Virox5, CaviWipes, Viro-Chek, Alcide LD.



STANDARD SIZES

Size	Foam	*Bariatric Foam	Gel-Foam	*Bariatric Gel-Foam
16" x 16" x 2"	9593-161602	9593B-161602	9593-GEL-161602	9593B-GEL-161602
16" x 16" x 3"	9593-161603	9593B-161603	9593-GEL-161603	9593B-GEL-161603
18" x 16" x 2"	9593-181602	9593B-181602	9593-GEL-181602	9593B-GEL-181602
18" x 16" x 3"	9593-181603	9593B-181603	9593-GEL-181603	9593B-GEL-181603
20" x 16" x 2"	9593-201602	9593B-201602	9593-GEL-201602	9593B-GEL-201602
20" x 16" x 3"	9593-201603	9593B-201603	9593-GEL-201603	9593B-GEL-201603

*Bariatric Density Foam

Rotational cover also available in a wheelchair overlay. Pg. 22



Visco Foam Cushion

RECOMMENDED USE: Patients at risk for pressure ulcers.

Foam Topper

Thin layer of foam dissipates heat, keeping surface cool and dry.

You choose the cover!

See the chart below and choose the cover that suits your needs best.

Memory Foam

Visco memory foam supports and contours to body shape for maximum comfort.

High Density Foam

High density stabilizing foam provides support and comfort.



STANDARD SIZES

Size	Model	Cover Type	Cover Information	Cover Properties
18" x 16" x 3"	9593-VSC-181603	Rotational Cover	See Page 18	AM WP WR CSA
18" x 16" x 3"	9595-VSC-181603	Fluid-Proof Cover	See Page 16	WP CSA
18" x 16" x 3"	9597-VSC-181603	Breathable Stretch Cover	See Page 10	AM WR CSA
18" x 16" x 3"	VSC-181603-SC	Sure-Chek Cover	See Page 18	AM WP HA TC CSA



Solid Seat Insert

AM WP CSA

RECOMMENDED USE: For use with cushions without firm core foundation. Eliminates hammocking.

STANDARD SIZES

Size	Model
16" x 16" x 1 1/2"	9-SSI-1616
18" x 16" x 1 1/2"	9-SSI-1816
20" x 16" x 1 1/2"	9-SSI-2016
22" x 18" x 1 1/2"	9-SSI-2218
24" x 16" x 1 1/2"	9-SSI-2416
26" x 16" x 1 1/2"	9-SSI-2616
26" x 18" x 1 1/2"	9-SSI-2618



Seating & Positioning Overlays

NYORTHO WHEELCHAIR & GERI-CHAIR OVERLAYS

NYOrtho comfort seats provide protection of sensitive skin and comfortable seating. Comfort seats are secured in place with adjustable velcro straps and designed for use with positioning belts and many other accessories. Available in many different sizes, all comfort seats are machine washable and offer many different fabric options to suit your needs.



Comfort Seats

METRIS™ Comfort Seat AM WP WR

MODEL 9522GC-GEL

Actual Dimensions: 72"L x 19"W x 3"H

Easy-To-Attach Quick-Release Straps

Rotational Cover Fluid-Resistant

Super soft PEACHSKIN fabric is strong, durable, antimicrobial, and fluid resistant - improves moisture evaporation. CA 117-2013



Rotational Cover Fluid-Proof

SURE-CHEK™ thermoplastic fabric composites are strong, durable, antimicrobial, anti-static, flame resistant, stain, odor, and fluid proof.

SURE-CHEK™ Approved Disinfectants: When used in accordance with mfg. recommendation: Virox5, CaviWipes, Viro-Chek, Alcide LD.



Visco Elastic Memory Foam

Visco memory foam supports and contours upper body shape for maximum comfort.

Foam / Gel Seating Surface

High-density foam surrounds an internal dual-chamber gel pod, providing a cool and comfortable interface that evenly maintains gel in the area of the highest pressure, preventing skin breakdown.

Independent-Cell Foam Body

High-performance independent-cell foam cavity provides greater air-flow and circulation to the legs.

ULTRA-LIFT™ Comfort Seat AM WP

MODEL 9523GC-GEL

Actual Dimensions: 65"L x 19"W x 3"H

Foam / Gel Seating Surface

High-density foam surrounds an internal dual-chamber gel pod, providing a cool and comfortable interface that evenly maintains gel in the area of the highest pressure, preventing skin breakdown.

Independent-Cell Heel Suspension Cushion

Wedge shaped foam cushion elevates heel providing zero-g pressure.



Visco Elastic Memory Foam

Visco memory foam supports and contours upper body shape for maximum comfort.

Easy-To-Attach Quick-Release Straps

Fluid-Proof Sure-Chek Cover

SURE-CHEK™ thermoplastic fabric composites are strong, durable, antimicrobial, anti-static, flame resistant, stain, odor, and fluid proof. **SURE-CHEK™** Approved Disinfectants: When used in accordance with mfg. recommendation: Virox5, CaviWipes, Viro-Chek, Alcide LD.





Geriatric Chair Comfort Seat

- Oversized arm rest portion provides wider seat coverage up to 24"W
- Soft hypoallergenic micro-fiber filling for added comfort
- Easily attaches with velcro straps
- Available in short and full sizes
- Designed for use with positioning belts
- Meets CA 117-2013 standard
- Machine washable



9519GC

Geriatric Chair Comfort Seat Antimicrobial Water-Resistant

AM WR CSA

RECOMMENDED USE: Patients requiring long-term seating comfort and/or protection of sensitive skin.

- Super-soft peachskin fabric - antimicrobial / water-resistant

STANDARD SIZES

Model	Size	Dimensions	Fits G/C
9519GC-S	Short	47"L x 18"W	18" - 24"
9519GC	Full	72"L x 18"W	18" - 24"



9519GC-S



9520GC

Geriatric Chair Comfort Seat Water-Resistant

WR CSA

RECOMMENDED USE: Patients requiring long-term seating comfort and/or protection of sensitive skin.

- Low shear taslon fabric - water-resistant

STANDARD SIZES

Model	Size	Dimensions	Fits G/C
9520GC-S	Short	47"L x 18"W	18" - 24"
9520GC	Full	72"L x 18"W	18" - 24"



9520GC-S



9521GC

Geriatric Chair Comfort Seat Plaid

CSA

RECOMMENDED USE: Patients requiring long-term seating comfort and/or protection of sensitive skin.

STANDARD SIZES

Model	Size	Dimensions	Fits G/C
9521GC-S	Short	47"L x 18"W	18" - 24"
9521GC	Full	72"L x 18"W	18" - 24"



9521GC-S



Seating & Positioning Overlays



FLAME RESISTANT: All **Sure-Chek** healthcare fabrics are flame resistant and self-extinguish when a source flame is removed.

ANTIMICROBIAL FABRIC PROTECTION: The antimicrobial agent helps protect the fabric from microbial attack and reduces undesirable organic odors.

THERMAL CONDUCTIVITY: **Sure-Chek** healthcare fabrics all perform within a desirable range for patient comfort without sacrificing important technical

performance benefits.

FLUID RESISTANCE & MOISTURE VAPOR TRANSMISSION: All **Sure-Chek** healthcare fabrics are fluid and moisture resistant, reducing the risk of contamination of the mattress from liquids or bodily fluids.

HYPOALLERGENIC: **Sure-Chek** healthcare fabrics have been engineered to be hypoallergenic and comfortable for the user.

Comfort Seats

Rotational Comfort Seats

MODEL 9522 Series
2 Covers in 1

Rotational Cover Fluid-Resistant

Super soft **PEACHSKIN** fabric is strong, durable, antimicrobial, and fluid resistant - improves moisture evaporation.



Rotational Cover Fluid-Proof

SURE-CHEK™ thermoplastic fabric composites are strong, durable, antimicrobial, anti-static, flame resistant, stain, odor, and fluid proof.

SURE-CHEK™ Approved Disinfectants: When used in accordance with mfg. recommendation: Virox5, CaviWipes, Viro-Chek, Alcide LD.

Rotational cover also available in a wheelchair cushion. Model 9593. Pg. 18



9522GC

Geri-Chair Comfort Seat Rotational Cover

AM WP WR CSA

RECOMMENDED USE: Patients requiring long-term seating comfort and/or protection of sensitive skin.

STANDARD SIZES

Model	Size	Dimensions	Fits G/C
9522GC-S	Short	47" L x 18" W	18" - 24"
9522GC	Full	72" L x 18" W	18" - 24"



9522GC-S



9522

Wheelchair Comfort Seat Rotational Cover

AM WP WR CSA

RECOMMENDED USE: Patients requiring long-term seating comfort and/or protection of sensitive skin.

STANDARD SIZES

Model	Size	Dimensions	Fits W/C
9522	Short	36" L x 17" W	16" - 22"
9522L	Reg	47" L x 17" W	16" - 22"
9522XL	Full	54" L x 17" W	16" - 22"



9522XL



9522L



Wheel-Chair Comfort Seat

- Oversized arm rest portion provides wider seat coverage up to 22"W
- Soft hypoallergenic micro-fiber filling for added comfort
- Easily attaches with velcro straps
- Available in short, regular and full sizes
- Designed for use with positioning belts
- Meets CA 117-2013 standard
- Machine washable



9519

Wheelchair Comfort Seat Antimicrobial Water-Resistant

AM WR CSA

RECOMMENDED USE: Patients requiring long-term seating comfort and/or protection of sensitive skin.

- Super-soft peachskin fabric - antimicrobial / water-resistant

STANDARD SIZES

Model	Size	Dimensions	Fits W/C
9519	Short	36"L x 17"W	16" - 22"
9519L	Reg	47"L x 17"W	16" - 22"
9519XL	Full	54"L x 17"W	16" - 22"



9519XL



9519L



9520

Wheelchair Comfort Seat Water-Resistant

WR CSA

RECOMMENDED USE: Patients requiring long-term seating comfort and/or protection of sensitive skin.

- Low shear taslon fabric - water-resistant

STANDARD SIZES

Model	Size	Dimensions	Fits W/C
9520	Short	36"L x 17"W	16" - 22"
9520L	Reg	47"L x 17"W	16" - 22"
9520XL	Full	54"L x 17"W	16" - 22"



9520XL



9520L



9521

Wheelchair Comfort Seat Plaid

CSA

RECOMMENDED USE: Patients requiring long-term seating comfort and/or protection of sensitive skin.

STANDARD SIZES

Model	Size	Dimensions	Fits W/C
9521	Short	36"L x 17"W	16" - 22"
9521L	Reg	47"L x 17"W	16" - 22"
9521XL	Full	54"L x 17"W	16" - 22"



9521XL



9521L



Wheelchair Accessories

Positioning

Increase comfort, improve posture and prevent foot-drop.

Footrest Extenders, Leg Rest Pads and Wheelchair Footrest Bag are all covered in water-repellent, wipe-clean vinyl.



Footrest Extender Leg Rest Pad



9547

Leg Rest Pad WP CSA

RECOMMENDED USE: Patients needing cushioned leg support and/or preventing feet from slipping behind footrest.

- Provides a cushioned leg support and helps prevent resident's feet from slipping off the footrest and getting caught under the chair.
- Pads are secured easily with quick-release straps.

STANDARD SIZES

Model	Dimensions	Fits W/C
9547	16"W x 9"H	16" - 20"
9547-22	22"W x 9"H	22" - 24"
9547-24	24"W x 9"H	24" - 26"



9548

Footrest Extender / Leg Rest Pad WP CSA

RECOMMENDED USE: Patients needing lower extremity support and/or cushioned leg support, while preventing feet from slipping behind footrest.

- Increases the base of support and elevate the footrest, thereby increasing resident comfort, improving posture, and preventing foot-drop.
- Extenders are available in 1" and 2" heights.
- Includes Leg Rest Pad above.

STANDARD SIZES

Model	Size Extender	Size Pad	Fits W/C
9548-1620-1	15½"W x 8"D x 1"H	16"W x 9"H	16" - 20"
9548-1620-2	15½"W x 8"D x 2"H	16"W x 9"H	16" - 20"
9548-2224-1	21½"W x 8"D x 1"H	22"W x 9"H	22" - 24"
9548-2224-2	21½"W x 8"D x 2"H	22"W x 9"H	22" - 24"



9548B

Wheelchair Footrest Bag WP CSA

RECOMMENDED USE: Patients requiring storage of personal items.

- Provides storage of personal items and is a perfect stowaway for the Footrest Extender and Leg Rest Pad.

STANDARD SIZES

Model	Dimensions	Fits W/C	Case/MC
9548B-1620	15½" x 23½"	16" - 20"	25/50
9548B-2224	23" x 23½"	22" - 24"	25/50

Lap Cushions **Rx ONLY**

NYOrtho Wheelchair Lap Cushions help assist in upper body alignment, providing upper torso support and an elevated resting spot for hands. Available in a variety of styles to accommodate different wheelchair designs. Constructed from medium density foam. Wipe-clean cover.



9526

Wheelchair Lap Cushion, Self-Releasing **WP**

RECOMMENDED USE: Patients needing upper torso support or an elevated resting spot for hands.

- Simple-to-use hook and loop closure for easy self-release
- Ideal for residents with minimal hand/arm movement, releases automatically as the resident rises
- Fits wheelchairs and geri-chairs

STANDARD SIZES

Model	Dimensions	Fits W/C
9526	20"W x 4"H	18" - 22"



9527

Wheelchair Lap Cushion, Full Arm **WP**

RECOMMENDED USE: Patients needing upper torso support or an elevated resting spot for hands.

- Front notches accommodate full arm wheelchair

STANDARD SIZES

Model	Dimensions	Fits W/C
9527-1620-3	27"W x 3"H	16" - 20"
9527-2022-3	31"W x 3"H	20" - 22"



9528

Wheelchair Lap Cushion, Desk Arm **WP**

RECOMMENDED USE: Patients needing upper torso support or an elevated resting spot for hands.

STANDARD SIZES

Model	Dimensions	Fits W/C
9528-18-3	27"W x 18"D x 3"H	18"

- Side notches accommodate desk arm wheelchairs



Wheelchair Accessories

Increases patient safety, provides convenient storage and promotes patient dignity.

NYOrtho Wheelchair & geri-chair accessories provide increased resident protection and promotes comfortable seating.



9530

Smoker's Apron CSA

RECOMMENDED USE: Facilities needing to safeguard patients against possible burns from smoking materials and flame.

- Certified flame-retardant fabric meets NFPA 701
- Fire proof apron cannot be ignited by a cigarette, cigar or burning match
- Velcro side straps prevent cigarettes and ashes from falling between resident and the wheelchair
- Wipe clean, lightweight and fold-able
- Available over sized for Geri-chair (9531)
- **Deluxe version exceeds fire-rating NFPA-701**
- Universal sizing



9532

STANDARD SIZES

Model	Description	Dimensions	Type
9530	Economy, White	30"W x 34"L	Wheelchair
9531	Oversized, Economy, White	30"W x 44"L	Geri-Chair
9532	Deluxe, Grey	30"W x 34"L	Wheelchair



9540

Modesty Apron CSA

RECOMMENDED USE: To maintain resident's dignity by adding a modest covering when sitting in a wheelchair or geri-chair.

- Full sized apron extends past the knees
- Features a large pocket that provides easy access to personal items
- Made of durable, wash and wear polyester blend

STANDARD SIZES

Model	Dimensions
9540	32"W x 36"L



9546

Oxygen Cylinder Holder WP

RECOMMENDED USE: Patients requiring oxygen.

- Economical alternative to steel tank holders
- Adjustable straps position the tank off center avoiding patient's head or back
- Made of easy-to-clean, heavy-duty waterproof nylon
- Attaches with easy-to-adjust quick-release buckles

STANDARD SIZES

Model	Size	Dimensions
9546	Size E (M24) Tank	27¼" x 7½"



9550

Urinary Drain Bag Holders WP

RECOMMENDED USE: Provides a modest covering for patients requiring urine drainage bags

- Preserves resident dignity by hanging discreetly under wheelchair, geri-chair or bed
- Secured in place with adjustable straps
- Universally sized, holds all drainage-bags
- Available in wipe-clean vinyl or washable canvas

STANDARD SIZES

Model	Style	Size	Case/MC
9549	Canvas	Universal	25/100
9550	Vinyl	Universal	25/100



9552 - 9556

Wheelchair Sheepskin Pads CSA

RECOMMENDED USE: Patients requiring protection of sensitive skin and/or improved seating comfort.

- Hi-pile, non-allergenic, synthetic sheepskin helps promote air circulation
- Provides a comfortable base preventing skin from sticking to wheelchair vinyl seats and backs
- Easy to attach velcro closure
- Sold as a set or individually
- Meets CA 117-2013
- Machine washable

STANDARD SIZES

Model	Type	Unit
9552	Complete Set	Set
9553	Armrest Pads	Pair
9554	Leg Pad	Each
9555	Footrest Pads	Pair
9556	Seat & Backrest Pads	Set



Wheelchair Accessories

Positioning

Resident-Release Belts

- Resident-release belts help position patient and provide added safety
- Available in cushion belt for added patient comfort and economy nylon belts
- Multiple closures available including easy-on/easy-off quick-release buckle and one handed resident-friendly buckle
- Covered in a soft water-resistant tason fabric
- Easy to adjust universal sizing, machine washable

Resident-Release Cushion Belts

AM WR

RECOMMENDED USE: Patients who are require a positioning device and added safety.

- Easily secures to wheelchair via rear adjustable loops

STANDARD SIZES

Model	Closure	Dimensions
9703	Velcro® Hook & Loop	6" x 24"
9704	Quick-Release Buckle	6" x 24"
9705	Velcro® Hook & Loop W/Red Loop Pull	6" x 24"
9706	Resident-Friendly Buckle	6" x 24"

*Straps not included in dimensions.



9703



9704



9705



9706

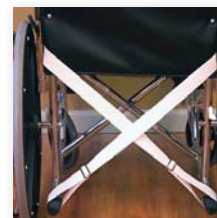

9710

Resident-Release Nylon Belts

RECOMMENDED USE: Patients who are require a positioning device and added safety.

- Easily secures to wheelchair via rear adjustable buckle (9716) or directly to wheelchair frame via screw (9710)

STANDARD SIZES

Single Pack	10/Pack	Closure	Attaches	Length
9710-42	9710-42-10	Quick-Release Buckle	Screw Direct to Frame	42"
9716	9716-10	Resident-Friendly Buckle	Rear-Removable Buckle	51 ¼"



9716

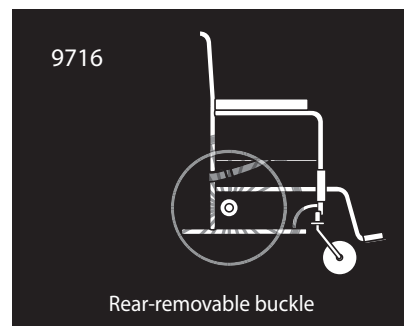
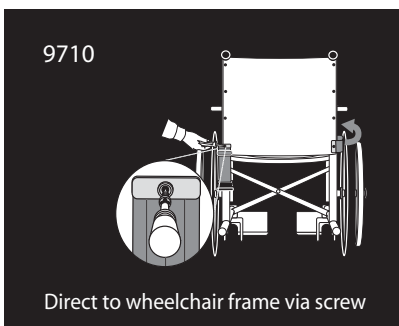

Restraint Belts **Rx ONLY**

NYOrtho Cushion Belts provide both safety and comfort while in a wheelchair. Prevents forward sliding as well as maintaining patient position while seated.

- Restraint belts help position patient and reduce sliding
- Available in cushion belt for added patient comfort or economy nylon belt
- Cushion belts are covered in a soft water-resistant tason fabric
- One size fits all. Machine washable



Wheelchair Accessories Restraints



9693

Economy Wheelchair Belt

RECOMMENDED USE: Patients who are at risk of forward sliding or require assistance with ambulation.

- Heavy-duty 2" wide nylon belt
- Attaches with adjustable slide buckles to wheelchair tilt bars
- For wheelchair use only

STANDARD SIZES

Single Pack	10/Pack	Dimensions
9693	9693-10	2" x 51"



9700, 9701, 9702

Cushion Belts **WR**

RECOMMENDED USE: Patients who are at risk for forward sliding or require assistance with ambulation.

- Softly padded, water-resistant tason belt
- Rear closure available with easy to use ties, easy-on, easy-off adjustable slide buckles and quick-release buckle.
- Size: Universal

STANDARD SIZES

Model	Style	Dimensions	Application
9700	Ties	6" x 24"	W/C, Bed
9700-L	Ties	6" x 32"	W/C, Bed
9701	Quick-Release Buckle	6" x 24"	W/C
9702	Adjustable-Loop	6" x 24"	W/C

**Straps not included in dimensions.*

Adjustable Slide Buckles

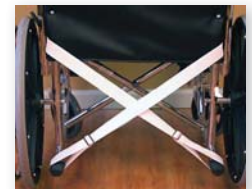

Quick-Release Buckle



9700S

Pelvic Cushion Belt **WR**

RECOMMENDED USE: Patients who have a tendency to slide forward.

- Softly padded, water-resistant tason belt greatly reduces forward sliding by securing pelvic area
- Rear closure with easy to use ties

STANDARD SIZES

Model	Style	Dimensions	Application
9700S	Ties	6" x 24"	W/C

**Straps not included in dimensions.*

Restraints

The determination as to the appropriateness of any model restraint is the responsibility of the facility and it's professional/medical staff. Individual requirements will vary and a complete assessment of each person's specific situation and condition, as well as, of current regulatory guidelines, should be implemented before any decision is made regarding the choice of a particular product.



Patient Safety Restraints



9509-C

Sheepskin Limb Holder

RECOMMENDED USE: Patients assessed to be at risk of disrupting life-saving treatment, causing self-injury, or compromising wound site integrity.

- Non-allergenic, flame retardant, imitation sheepskin
- One size fits all, hook & loop closure
- Machine washable, meets CA 117-2013

STANDARD SIZES

Model	Size	Type	Unit
9509-C	Universal	Wrist	Pair



9370

Padded Mitts

RECOMMENDED USE: Patients who are prone to pull at their IV line/catheter or are prone to self-injury.

- Available lightweight mesh back promotes air circulation and visual inspection (9370)
- Ultra-soft, **ANTIMICROBIAL** interior velvet fabric is a gentle on the skin
- Half-inch comfortable cushioned padding protects skin
- No finger separators
- Easy application and closure, for bed or wheelchair
- For use with or without the arm movement control straps
- Machine washable

STANDARD SIZES

Model	Size	Unit
9370	Padded / Mesh	Pair
9371	Dual Padded	Pair

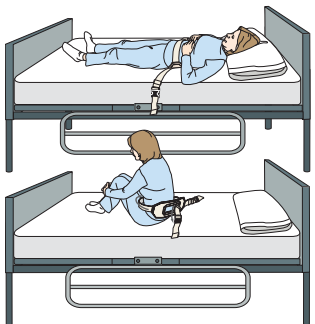

9696

Patient Roll Belt

RECOMMENDED USE: Patients at risk of falls or those requiring a restraint.

- Recommended for a patient that requires a reminder not to leave the bed without assistance
- Less restrictive restraint allows side to side motion in bed
- Straps attach to bed frame out of patient's reach with quick-release buckle
- Universal sizing

STANDARD SIZES

Model	Size
9696	Universal



9697

Patient Safety Vest

RECOMMENDED USE: Patients at risk of falls or those requiring a restraint.

- Sleeveless restraint vest helps prevent unassisted bed or chair exit
- Straps tie behind chair, out of patient's reach
- Effective as a wheelchair or bed restraint
- Available in three sizes
- Easy-to-apply

STANDARD SIZES

Model	Size	Weight (lb / kg)
9697-S	Small	80 lb - 130 lb (26 kg - 59kg)
9697-M	Medium	130 lb - 160 lb (59 kg - 73 kg)
9697-L	Large	160 lb - 200 lb (73 kg - 91 kg)



9699

Pelvic Holder

RECOMMENDED USE: Patients who are at risk for forward sliding.

- Helps prevent forward sliding in a wheelchair or geri-chair
- Straps tie behind wheelchair or geri-chair, out of patient's reach
- Soft Poly / Cotton Fabric
- Available in two sizes
- Easy to apply

STANDARD SIZES

Model	Size	Weight (lb / kg)
9699-SM	Small / Medium	Up to 170 lbs / 77 kgs
9699-ML	Medium / Large	Over 170 lbs / 77 kgs

Ambulance Stretcher Pads & ER/OR Pads

AM WP HA TC CSA

RECOMMENDED USE: For patients requiring emergency transport.

Constructed of specially conductive fabric helps control electrostatic discharge. This conductive cloth also prevents the accumulation of a static charge that would interfere with sensitive electronic equipment. When you use conductive fabric, you're taking the extra step you need to protect your patients. In addition to its conductive properties, our fabric is fluid-proof and antimicrobial. Made with heavy-duty foam. CA 117-2013.



Patient Safety

Model 9577



Custom shapes and sizes made to order!

STANDARD SIZES

Model	Usage Type	Size	Unit
9577-XXXXXX	Ambulance	Custom	Each
9578-XXXXXX	ER & OR	Custom	Each



Model 9578

Door Guard CSA Door Guard Alarm

RECOMMENDED USE: For wandering patients; to deter unauthorized entry or exits.

- The Door Guard provides a visual reminder to residents not to exit or enter through the guarded doorway
- Attaches easily with adhesive hook and loop strips to the door frame and removes easily in case of emergency
- For use with Door Guard Alarm (9797-ALRM)
- Many sizes available



- Provides an audible reminder to residents not to exit or enter through the guarded doorway.
- Bi-level alarm sounds when banner is detached
- Battery operated with 9-Volt battery (included)
- Low battery indicator
- For use with Door Guard (9797)

STANDARD SIZES

Door Guard & Alarm	Door Guard Only	Size	Unit
9797-40-ALRM	9797-40	40"	Each
9797-48-ALRM	9797-48	48"	Each
9797-53-ALRM	9797-53	53"	Each
9797-60-ALRM	9797-60	60"	Each
9797-ALRM	Alarm Only		Each



Fall Management Bedside Mats

Bedside Safety Mats

Bedside Safety Mats help reduce the possibility of impact related injuries and provide full-length coverage of the bed exit area. Bi-fold design easily slides under the bed when not in use and a beveled edge is available to accommodate wheelchairs, beds and lifts. Each safety mat features fire-resistant properties. Designed with a skid-resistant bottom that prevents slipping and aids in ambulation, a Sure-Grip option is available that secures the mat to most floor surfaces. Fire resistant - meets CA 117-2013 standards

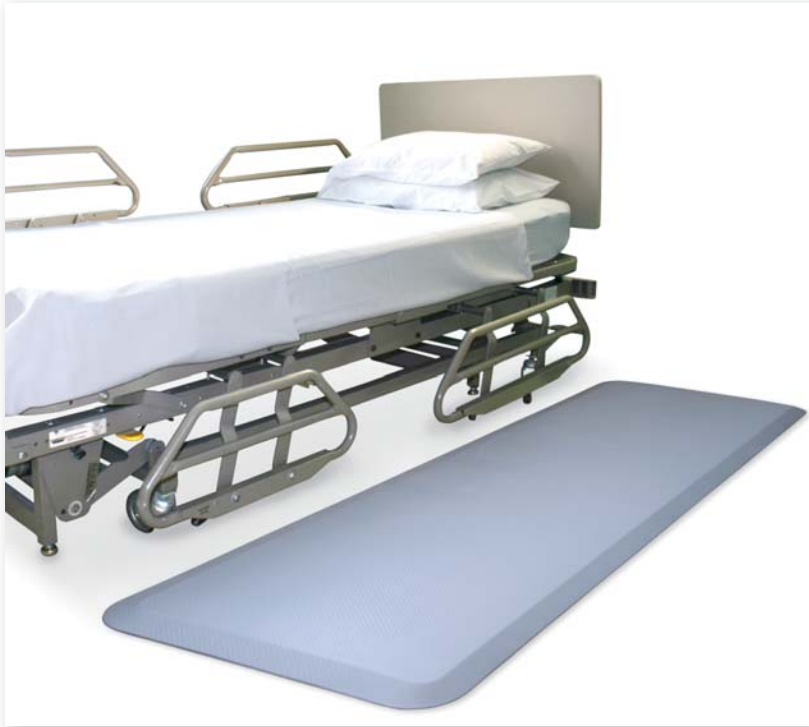

9576

NYOrtho FALLSHIELD™ Bedside Safety Mat AM WP

RECOMMENDED USE: Patients at risk of falls.

STANDARD SIZES

Size	Style	Edge	Model
1" x 24" x 70"	Non-Fold	Beveled	9576-012470

- One-inch padding provides necessary impact attenuation performance requirements
- Impact absorbing durable molded foam/rubber prevents patient injury from falls
- Low profile and beveled edge allow easy on and off for wheelchairs, beds and lifts
- Ample size provides full coverage of the bed area
- Non-slip textured top helps prevent caregiver/patient slipping
- Non-skid slide resistant bottom keeps mat in place
- Easy to clean, fluid-proof cover

Ultra-Lite Hip Protector

RECOMMENDED USE: Patients at risk for falling; those at risk for a hip fracture



9960

- Most proven economical hip protector on the market.
- Unique energy absorbing foam pads conform to the contour of the body for secure fit.
- Sold as a kit with two pairs of briefs and one set of removable pads.
- Lite, breathable, latex-free, polyester/span-dex fabric for optimal comfort.

STANDARD SIZES

Size	Size	Waist	Hips
9960-S	Small	25" - 30"	30" - 38"
9960-M	Medium	30" - 35"	35" - 43"
9960-L	Large	35" - 40"	40" - 48"
9960-XL	XL	40" - 45"	44" - 54"
9960-2XL	2XL	45" - 50"	48" - 60"

*Independent laboratory tests reduce the amount of force transmitted to the hip trochanter bone by 32.8%. This places our pads in the top five best performing pads in a side-by-side test performed by an independent research institute(1).

1. Based on Laing et al., Journal of Biomechanics (2011) Volume 44, pages 2627-2635, completed with results of recent independent test results of BeoHip pads by S. Robinovitch



Bedside Safety Mats

- High-impact foam helps prevent patient injury from falls
- Features a fluid-proof, antimicrobial, mildew-resistant, wipe-clean cover
- Bi-fold design easily slides under the bed when not in use
- Skid-resistant bottom that prevents slipping
- Available in tear-resistant, PVC coated taffeta or extra durable 3-ply vinyl
- Meets CA 117-2013 Standards



9570 / 9579

Bedside Safety Mat

AM WP CSA

RECOMMENDED USE: Patients at risk of falls.

STANDARD SIZES

Size	Style	PVC Coated Taffeta	3-PLY Vinyl
2" x 24" x 60"	Bi-Fold	9570-022460	9579-022460
2" x 24" x 66"	Bi-Fold	9570-022466	9579-022466
2" x 24" x 72"	Bi-Fold	9570-022472	9579-022472
2" x 36" x 68"	Bi-Fold	9570-023668	9579-023668
3" x 24" x 66"	Bi-Fold	9570-032466	9579-032466
3" x 24" x 72"	Bi-Fold	9570-032472	9579-032472
3" x 30" x 72"	Bi-Fold	9570-033072	9579-033072
4" x 24" x 60"	Bi-Fold	9570-042460	9579-042460
4" x 36" x 68"	Bi-Fold	9570-043668	9579-043668



9579BV

Beveled Edge Bedside Safety Mat

AM WP CSA

RECOMMENDED USE: Patients at risk for falls.

- Low profile beveled edge design allows resident to stand, walk or wheel over the mat without difficulty

STANDARD SIZES

Size	Style	3-PLY Vinyl
1" x 24" x 66"	Tri-Fold	9579BV-012466



9579TR

TRI-Fold Bedside Safety Mat

AM WP CSA

RECOMMENDED USE: Patients at risk of falls

- Tri-fold design is easy to carry and store

STANDARD SIZES

Size	Style	3-PLY Vinyl
1½" x 24" x 72"	Tri-Fold	9579TR-1H2472



Bed Accessories Safety

Bed Safety

NYOrtho bed safety products and accessories provide safety and comfort for your patients. Bed Rail Pads help minimize accidental patient injuries resulting from striking bedside rails and bedside rail entrapment.

- Soft padding helps prevent patient injury and deter patient exits between side rails
- Hook & loop closure fasten pads securely to bed rails
- Rails may be raised or lowered without removing bed rail pad
- Vinyl cover wipes clean for easy disinfecting
- Available in half and full rail sizes
- Meets CA 117-2013 standard



9557

Sheepskin Bed Rail Pads

RECOMMENDED USE: Patients at risk for bed entrapment and injury via side rails.

STANDARD SIZES

Model	Size	Type	Unit
9557-24	18" x 24"	Half-Rail	Pair
9557-30	18" x 30"	Half-Rail	Pair
9557-34	18" x 34"	Half-Rail	Pair
9557-42	18" x 42"	Half-Rail	Pair
9557-48	18" x 48"	Full-Rail	Pair
9557-56	18" x 56"	Full-Rail	Pair
9557-60	18" x 60"	Full-Rail	Pair
9557-72	18" x 72"	Full-Rail	Pair



9565

Vinyl Bed Rail Pads WP CSA

RECOMMENDED USE: Patients at risk for bed entrapment and injury via side rails.

STANDARD SIZES

Model	Size	Rail Type	Unit
9565-011124	1" x 11" x 24"	Half-Rail	Pair
9565-011134	1" x 11" x 34"	Half-Rail	Pair
9565-01H1134	1½" x 11" x 34"	Half-Rail	Pair
9565-011169	1" x 11" x 69"	Full-Rail	Pair



9565

Split Rail Vinyl Bed Rail Pads WP CSA

RECOMMENDED USE: Patients at risk for bed entrapment and injury via side rails.

- Stretch hook & loop closure fasten pads securely to bed rails

STANDARD SIZES

Model	Size	Unit
9565-010928-S	1" x 9" x 28"	Set of 4



9565

Cushioned Top Vinyl Bed Rail Pads WP CSA

RECOMMENDED USE: Patients at risk for bed entrapment and injury via side rails.

- Cushioned top of rail for added protection

STANDARD SIZES

Model	Size	Unit
9565-011537-C	1" x 15" x 37"	Pair
9565-011550-C	1" x 15" x 50"	Pair



Bed Accessories Safety



9560

Sheepskin Bed Pads

RECOMMENDED USE: Patients at low risk of skin ulcers

Soft, plush, synthetic sheepskin bed pads help make any bed cozy and comfortable. Used in many products, synthetic sheepskin is soft to the touch and feels wonderful against the skin.

- Low shear, non-allergenic synthetic sheepskin reduces risk of pressure sores
- High-pile fur promotes air circulation beneath the resident and provides comfortable cushioning
- Available in many sizes to suit your needs
- Machine washable
- Meets CA 117-2013

STANDARD SIZES

Model	Size	Unit
9560-2430	24" x 30"	Each
9560-3040	30" x 40"	Each
9560-3060	30" x 60"	Each
9560-4880	48" x 80"	Roll

Gap Guard WP CSA

RECOMMENDED USE: Patients at risk of bed entrapment and/or injury.



9567

- Helps fill gaps between mattress and headboard and/or foot-board, preventing arm and leg entrapment
- Wedge shape fills gaps up to three inches wide
- May be doubled to accommodate wider spaces
- Works when side rails are raised or lowered
- Covered in an incontinence-proof, wipe-clean nylon
- Meets CA 117-2013

STANDARD SIZES

Model	Size	Unit
9567-35	35"	Pair
9567-70	70"	Pair

Repositioning Slide WP CSA

RECOMMENDED USE: Patients requiring assistance to reposition and at risk of skin breakdown/friction burns.

Slide sheets are used for repositioning, turning and moving residents up in bed.



9580

- Tubular design and multiple handles facilitates easy repositioning
- Low-friction bullet nylon fabric makes repositioning easy and effortless, preventing caregiver neck and back injury
- Protects residents skin integrity and allows for safer repositioning by significantly reducing friction and shearing
- Machine washable

STANDARD SIZES

Model	Size
9580-26H75	26½" x 75"
9580-3475	34" x 75"

Roll Control Bolster WP

RECOMMENDED USE: Patients inclined to unassisted bed exit and/or falling out of bed.

Roll-Control Bolsters are a safe alternative to side rails and help prevent patients at risk of falls from rolling out of bed, while providing sufficient space for patient comfort.



9912

- May be repositioned to accommodate individual resident needs, or may be completely removed
- Easy to attach with quick-release buckles
- Easy-to-clean wipe clean vinyl cover
- Not a restraint for most patients

STANDARD SIZES

Model	Size	Unit
9912	34"L x 7"H x 8"D	Set of 2



Bed Accessories Positioning

Support Pillows and Cushions

Natural placement of the head and neck, accomplished with the many different styles and shapes of support pillows and cushions, can help relieve intense pain by providing natural and correct posturing in supine (back) and side-sleeping positions. Cervical support pillows are used when a cervical hypolordosis (less than normal curvature of the spine) exists, to prevent hypolordosis, or when cervical spasms or strains occur. These pillows are orthotic devices (apparatus used to align or support) used to help relieve spasms, remove minor tensions and maintain or resume the natural cervical lordotic curve while at rest.

Positioning Wedge

AM WR CSA

RECOMMENDED USE: Patients requiring additional positioning and support.



- Helps reduce pressure points under bony prominences and the incidence of pressure ulcers.
- Recommended 30° angle of incline helps relieve pressure on hipbone and coccyx
- Breathable, low shear, stretch cover with antimicrobial protection reduces friction
- Slip resistant bottom prevents sliding
- CA 117-2013

STANDARD SIZES

Model	Size	Degree	Unit
9910-161105	5" x 11" x 16"	25°	Each
9910-161207	7" x 12" x 16"	30°	Pair
9910-170808	8" x 8" x 17"	45°	Pair
9910-221108	8" x 11" x 22"	36°	Each
9910-241207	7" x 12" x 24"	30°	Pair
9910-341207	7" x 12" x 34"	30°	Pair

Bariatric Positioning Wedge

AM WR CSA

RECOMMENDED USE: Patients requiring additional positioning and support.



STANDARD SIZES

Model	Size	Degree	Unit
9910-281082	2" x 8" x 10" x 28"	40°	Each

Elevating Bed Wedge

AM WR CSA

RECOMMENDED USE: Patients requiring head and/or chest elevation.



- Provides elevation to improve position
- Removable water-resistant cover is machine washable
- Made of comfortable high-density foam
- CA 117-2013

STANDARD SIZES

Model	Size	Degree	Unit
9911-242407	7" x 24" x 24"	16°	Pair
9911-242412	12" x 24" x 24"	26°	Pair

Pillows

AM WR

All pillows are filled with a hypoallergenic polyester fill and meet CA 117-2013 fire-rating standards.

Endurance Pillows: Safe Guard Barrier Systems® Certified



Endurance Wipe-Clean Pillows

- Reusable pillow with laminated vinyl cover
- Fluid proof, antimicrobial and anti-fungal
- Non-washable; wipe-clean surface

Comfort Pillows

- Reusable pillow in white poly/cotton fabric
- Antimicrobial and water-resistant
- Machine washable

STANDARD SIZES

Endurance	Comfort	Size	Unit
9620-1824	9624-1824	18" x 24"	6/Case
9620-2026	9624-2026	20" x 26"	6/Case
9620-2030	9624-2030	20" x 30"	6/Case



9600 / 9601

Cervical Pillow Roll

RECOMMENDED USE: Helps provide comfort and support.

- Specially shaped to help provide comfort and support to relieve neck tension, aches and stiffness
- Available in an economy polyurethane foam cushion or a soft hypoallergenic micro-fiber filling for added comfort
- Alternative uses include sacral or knee support
- Cotton/poly cover
- Machine washable, meets CA 117-2013

STANDARD SIZES

Model	Description	Size
9600	Polyurethane	6" x 16"
9601	Fiber-Fill	7" x 18"



9606

Comfort Cradle

RECOMMENDED USE: Helps restore and maintain cervical alignment.

- Promotes a level sleeping position, correctly positioning the head to properly align the spine and support the neck in its natural position.
- Helps relieve headaches and neck pain, for side and back sleepers alike.
- Formulated with a very soft, hypoallergenic polyester fiberfill
- Machine washable, meets CA 117-2013

STANDARD SIZES

Model	Size
9606	25" x 18"



9630

Double Lobe Cervical Pillow

RECOMMENDED USE: Helps provide comfort and support

- Double lobe cervical pillow provides a uniform firmness and improves the proper curvature of the neck.
- Formulated with hypoallergenic resilient medium density polyurethane foam
- Machine washable, meets CA 117-2013

STANDARD SIZES

Model	Size
9630	19" x 14"



9640

Lumbar Cushion

RECOMMENDED USE: Helps provide comfort and support

Lumbar cushion is shaped to maximize comfort while seated. Polyurethane foam provides a uniform firmness that improves posture and reduces stress to the lower back. Use at home, office, or in your car.

- Hypoallergenic polyurethane foam pillow is contoured to body shape
- Covered with a machine washable poly / cotton fabric
- One-inch elastic band to secure pillow
- Machine washable, meets CA 117-2013

STANDARD SIZES

Model	Size
9640	14" x 13"



Therapy & Ambulation Arm Slings

Shoulder Immobilizer

RECOMMENDED USE: Bankart repairs, SLAP lesion repairs, anterior dislocations, posterior capsule repairs, anterior repairs, rotator cuff repairs, and total shoulder reconstruction.

The Shoulder Immobilizer provides positional arm support and immobilization following upper extremity injuries and/or surgeries. This sling and pillow combination device can hold the shoulder/arm in a neutral position and helps prevent post-operative complications. Breathable spacer fabric and lightweight design enhances patient comfort.

- Provides post surgical support - positions and immobilizes the arm and shoulder.
- Simple to apply and comfortable to wear.
- Adjustable shoulder strap with padded neck for increased comfort.
- Waist strap positions and stabilizes the arm and shoulder.
- Removable foam abduction pillow maintains neutral position.
- Comfortable low-profile foam pad cushions the sling against body when worn without the abductor pillow.
- Exercise ball for muscle and circulatory stimulation.

STANDARD SIZES

Model	Size
8712-SM	Small / Medium
8712-LXL	Large / XL



Alternate foam pad cushions the sling against the body when worn without the abduction pillow.



8712

Hi-Performance Spacer Fabric Provides Cool Comfort

Spacer fabric is a specialized three-dimensional textile that uniquely facilitates air flow, breathability and lightweight shape support.



Velpeau Arm Sling WR

RECOMMENDED USE: For non-surgical treatment of bone, muscle, or ligament injury to the hand, arm or shoulder.

Velpeau positioning strap helps control shoulder rotation and provides support to the arm. Comfortably positions and stabilizes arm to promote healing.

- Velpeau arm sling helps control shoulder rotation and provides support to the arm
- Buckle closure securely fastens and provides Velpeau position
- Universal sizing
- Machine washable

STANDARD SIZES

Model	Size
8700	Universal



8700

Arm Slings

NYOrtho arm slings comfortably position and distribute the weight of the arm following surgical or non-surgical treatment of the arm, hand or shoulder. A strong, seamless design is easy to apply and comfortable to wear.



Therapy & Ambulation Arm Slings



8701

Envelope Arm Sling WR

RECOMMENDED USE: For non-surgical treatment of bone, muscle, or ligament injury to the hand, arm or shoulder.

- Comfortable arm slings position and stabilize arms to promote healing
- Available with velcro closure or metal buckle
- Standard sizes S-XL
- Machine washable

STANDARD SIZES

Velcro Closure	Metal Closure	Size
8701-S	8702-S	Small
8701-M	8702-M	Medium
8701-L	8702-L	Large
8701-XL	8702-XL	XL



8702



9590

Post Hip Surgery Cushion WR CSA

RECOMMENDED USE: Post hip surgery patients at risk of excessive flexion at hip joint.

The Post Hip Surgery Cushion is a lightweight and easy to use cushion that assists in the transition from sitting to standing from any chair. Fits most chairs, including straight backs and cushioned arm chairs.

- Removable cover designed with a water-resistant taslon fabric
- Convenient carry strap
- Meets CA 117-2013 Standard

STANDARD SIZES

Model	Description	Size
9590-151504	Foam-Cushion	15" x 15" x 4"



9820

Abduction Wedge / Knee Separator

RECOMMENDED USE: Patients with abduction contractures, recovering from hip replacement surgery and/or at risk of skin breakdown.

- Contoured sides maintain 4" knee separation
- Available in wipe-clean Sure-Chek fabric - antimicrobial, fluid-proof, hypoallergenic or breathable, stretch fabric - antimicrobial
- Hook receptive medical foam strap comfortably maintains leg position, excess strap can be trimmed
- For wheelchair or bed
- Meets CA 117-2013

STANDARD SIZES

Model	Dimensions	Fabric
9820-96	4" Wedge / 46" Strap	Sure-Chek Cover
9820-97	4" Wedge / 46" Strap	Stretch Cover





Therapy & Ambulation Gait Belts

Gait / Transfer Belts

NYOrtho Gait/Transfer Belts provide caregivers with a leveraged hold on the patient/resident to assist in safe transfer/ambulation and help prevent caregiver back injuries. Nickel-plated, metal buckles offer superior hold and durability. Quick-release buckles are easy to attach. Constructed of heavy-duty 2" cotton webbing and available in a variety of colors and patterns. Machine washable.



9507

NYOrtho Deluxe Gait Belt

RECOMMENDED USE: Patients requiring assistance with transfer or ambulation.

The Deluxe Gait Belt offers the simplicity of a gait belt with the added support of easy to grasp hand loops. Provides caregivers with improved hold on the patient/resident to assist in safe transfer/ambulation and helps prevent caregiver back injuries.

STANDARD SIZE

Model	Size	Fits
9507	Universal	25" - 55"

- Extra wide 4" high back for greater weight bearing leverage and comfort for the patient
- Six handles provide attendants with a firm grip to assist in the safe transfer or ambulation of patients
- Belt is secured with an adjustable quick-release buckle
- Soft nylon is machine washable
- Universal sizing



9505, 9506

NYOrtho Quick-Release Gait Belts

RECOMMENDED USE: Persons requiring transfer or ambulation assistance.

STANDARD SIZE

Deluxe Pastel	Pastel	Natural	Size	Unit
9505P-54	9506-54	9505W-54	54 Inch	Each / Pack
9505P-60	9506-60	9505W-60	60 Inch	Each / Pack
9505P-72	9506-72	9505W-72	72 Inch	Each / Pack

Benefits of an Ergonomic Program

Only a comprehensive ergonomic program can successfully prevent disabling back injuries and strain of sprain injuries. This program should:

- Identify the hazards in your facility.
- Use equipment and devices that make transfers safer and train everyone to be able to use this equipment correctly.
- Specify work practices like resident assessment and provide enough staff to help you perform a lift safely.
- Include a plan to support any worker who gets hurt.
- Have ongoing training and education of workers, supervisors and managers.



9503

NYOrtho Multi-Color Gait Belts

RECOMMENDED USE: Patients requiring assistance with transfer or ambulation.

STANDARD SIZE

Coral	Fiesta	Lavender	Pastel	Size	Unit
9503C-54	9503F-54	9503L-54	9503P-54	54 Inch	Each / Pack
9503C-60	9503F-60	9503L-60	9503P-60	60 Inch	Each / Pack
9503C-72	9503F-72	9503L-72	9503P-72	72 Inch	Each / Pack



9503N

NYOrtho Navy Gait Belt

RECOMMENDED USE: Patients requiring assistance with transfer or ambulation.

STANDARD SIZE

Navy	Size	Unit
9503N-54	54 Inch	Each / Pack
9503N-60	60 Inch	Each / Pack
9503N-72	72 Inch	Each / Pack



9503S

NYOrtho Stars & Stripes Gait Belt

RECOMMENDED USE: Patients requiring assistance with transfer or ambulation.

STANDARD SIZE

Stars&Stripes	Size	Unit
9503S-60	60 Inch	Each / Pack



9504, 9503W

NYOrtho Economy Gait Belt

RECOMMENDED USE: Patients requiring assistance with transfer or ambulation.

STANDARD SIZE

Pastel	Natural	Size	Unit
9504-54	9503W-54	54 Inch	Each / Pack
9504-60	9503W-60	60 Inch	Each / Pack
9504-72	9503W-72	72 Inch	Each / Pack



Therapy & Ambulation



9650

Fetal Monitoring Belt

RECOMMENDED USE: For use with a device to detect and trace the fetal heart rate and uterine contractions.

- Soft, latex-free elastic belt comfortably holds fetal monitor in place
- Lightweight and cool for minimal perspiration
- Available in button hole or velcro closure
- Come in a set - 1 pink / 1 baby blue

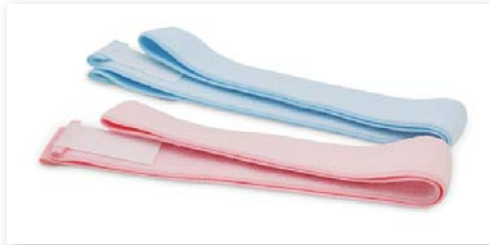

9651

STANDARD SIZE

Model	Style	Dimensions	Unit
9650	Button Hole	2¼" x 44"	50 Pair / Case
9651	Velcro	1½ x 34"	50 Pair / Case



8500

Universal Cervical Collar

RECOMMENDED USE: Mild neck pain, especially that caused by a condition within the cervical spine, pinched nerves, or whiplash injury.

- Helps provide relief from mild neck pain and stiffness
- Covered with a soft cotton beige stockinette
- Available in two heights: 3", 3½"
- Universal fit
- Easy to apply

STANDARD SIZE

3" Height	3½" Height	Size
8500	8600	Universal



9801

Palm Grips AM

RECOMMENDED USE: Individuals at risk of hand contractures.

- Highly absorbent terry cloth fabric with anti-microbial protection that absorbs perspiration
- Provides stimulation and exercise for hand ligaments and muscles
- Helps protect soft, irritated skin on fingers and palms
- May be utilized as a diversionary device for individuals prone to pulling at IV or feeding tubes
- Latex-free elastic strap holds grip in place
- Available in two sizes: regular and large

STANDARD SIZE

Model	Dimensions	Size
9801-R	5" x 2½"	Regular
9801-L	6" x 3"	Large



Abdominal Binders

Whether recovering from surgery or injury, or just need extra support, abdominal binders can stabilize your core and improve muscle tone. Made of comfortable, flexible materials, abdominal binders secure post-surgical dressings and provide compression to the upper and lower abdomen while improving blood circulation and oxygen levels. This in turn reduces swelling and promotes healing.



8000

Tapered Abdominal Binder CSA

RECOMMENDED USE: Patients in need of postoperative support of the abdomen.

- One-panel elastic plush elastic is soft on the skin
- Tapered design for better fit
- Adjustable velcro fastener for comfortable fit
- Available in 6", 9", 10", or 12" height
- Standard sizing
- Latex-Free

STANDARD SIZE

Size	6" Height	9" Height	10" Height	12" Height	Fits
Small	8000-S	8140-S	8142-S	8144-S	24" - 30"
Medium	8000-M	8140-M	8142-M	8144-M	30" - 36"
Large	8000-L	8140-L	8142-L	8144-L	36" - 42"
X-Large	8000-XL	8140-XL	8142-XL	8144-XL	42" - 48"
2XL	8000-2XL	8140-2XL	8142-2XL	8144-2XL	48" - 54"



8140

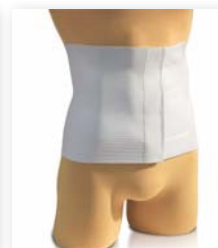

8142



8144



8100

Universal Abdominal Binder CSA

RECOMMENDED USE: Patients in need of postoperative support of the abdomen.

- Hook compatible elastic permits a closure at any point on the circumference of the binder
- Plush inner body is soft on the skin
- Options: Available in 9" or 12" height
- Universal sizing
- Latex-Free

STANDARD SIZE

Size	3-Panel		4-Panel	
	9" Height	12" Height	9" Height	12" Height
Small	8100-3045	8101-3045	8100-3045	8101-3045
Medium	8100-4662	8101-4662	8100-4662	8101-4662
Large	8100-6075	8101-6075	8100-6075	8101-6075
X-Large	8100-7590	8101-7590	8100-7590	8101-7590



Orthopedic & Rehabilitative Binders

Rib Belts

Ideal for stabilizing rib and sternum fractures by limiting chest expansion through compression. Easy adjustment with hook and loop closure.



8134

Universal Abdominal Binder CSA

RECOMMENDED USE: Patients in need of postoperative support of the abdomen.

- Soft medical foam body
- Plush inner-body is soft on the skin
- Adjustable velcro fastener for comfortable fit
- Options: Available in 9", 10" or 12"
- Universal sizing
- Latex-Free

STANDARD SIZE

Size	3-Panel		1-Panel		4-Panel	
	9" Height	10" Height	10" Height	12" Height	12" Height	Fits
Small	8130-3045	8132-3045	8134-3045	8134-3045	8134-3045	30" - 45"
Medium	8130-4662	8132-4662	8134-4662	8134-4662	8134-4662	46" - 62"
Large	8130-6075	8132-6075	8134-6075	8134-6075	8134-6075	60" - 75"
XL	8130-7590	8132-7590	8134-7590	8134-7590	8134-7590	75" - 90"



8200

Universal Rib Belt CSA

RECOMMENDED USE: Patients in need of stabilizing rib and sternum as a result of fractured or bruised ribs, intercostal muscle strains and costovertebral sprains.

- 6" high elastic with plush inner body
- Medical foam body for comfort
- Adjustable velcro fastener for comfortable fit
- Female style is contoured below bust line for better fit
- Universal sizing
- Latex Free

STANDARD SIZE

Model	Style	Size
8200-U	Female	28" - 46"
8210-U	Male	34" - 53"



8210

Lumbar Sacral Supports

Provides adjustable comprehensive support to help relieve the discomforts of low back pain. Helps stabilize lumbar, sacral, abdominal muscles and ligaments, relieving stress on the lower spine. Varying degrees of support can be achieved by using optional steel stays / pads or by selecting styles with alternative support features such as crisscross style or cinch pulls.



Orthopedic &
Rehabilitative
Lumbosacral



5610W

Lumbar Orthosis Support CSA

RECOMMENDED: To help treat and relieve pain associated with spondylolysis, burst fracture, spondylolithesis, postural support, chronic back pain, post laminectomy, spinal stabilization, compression fracture, discogenic disc disease, herniated or bulging disc, degenerative disc disease, lumbar muscle/ligament strain/sprain.

Lumbar Orthosis supports are used not only to supplement weakened or damaged muscles and joints, but also as a non-surgical means of treating many spinal disorders.

- 10" high back tapering to 5" front panels
- 4" Overlapping outer-belt provides additional compression to the abdominal and lumbar area
- Removable front panel with pocket / insert cradles and lifts abdomen
- Rear pocket with molded plastic insert (15° of lordosis) conforms to body shape
- Available in white (Latex-Free) or black
- Adjustable velcro fastener for comfortable fit
- Available Latex-free in white
- HCPCS Code L0627



STANDARD SIZE

Black	White	Fits	Size
5610B-S	5610W-S	26" - 32"	Small
5610B-M	5610W-M	30" - 37"	Medium
5610B-L	5610W-L	34" - 41"	Large
5610B-XL	5610W-XL	38" - 47"	XL
5610B-2XL	5610W-2XL	44" - 54"	2XL
5610B-3XL	5610W-3XL	50" - 62"	3XL



1000

Lumbar Sacral Support DCDO CSA

PROVIDES: Dual Compression Double Overlapping

- 10" high textile back tapering to 6" front elastic panels provides first layer of compression
- Two double overlapping outer-belts provide additional compression to the abdominal area
- Flexible polypro boning elements for added support
- Double-ply textile back with soft flannel lining
- Available with a removable foam pad or shaped steel stays
- Adjustable velcro fastener for comfortable fit
- Latex-free

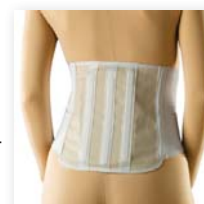

1000

STANDARD SIZE

Size	Fits	W/ Pad	W/ Steels
Small	26" - 30"	1000-S	2000-S
Medium	30" - 34"	1000-M	2000-M
Large	34" - 38"	1000-L	2000-L
X-Large	38" - 42"	1000-XL	2000-XL
2XL	42" - 46"	1000-2XL	2000-2XL

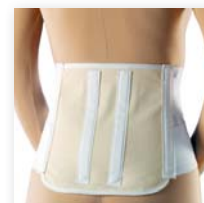

2000



**Orthopedic &
Rehabilitative**
Lumbosacral



Lumbar Sacral Support CC CSA

PROVIDES: Crisscross lumbar support

- 9" high all elastic back tapering to 4" front elastic panels
- All elastic construction comfortably enfolds body contours
- 4 flexible polypro boning elements for added support
- Available with a removable foam pad or gel-pack
- Adjustable velcro fastener for comfortable fit
- Latex-free

STANDARD SIZE

Size	Fits	Standard	W/Pad	W/Gel
Medium	30" - 34"	3009-M	4000-M	4000G-M
Large	34" - 38"	3009-L	4000-L	4000G-L
X-Large	38" - 42"	3009-XL	4000-XL	4000G-XL
2XL	42" - 46"	3009-2XL	4000-2XL	4000G-2XL



3009



4000

Universal Lumbar Sacral Support SCDS CSA

PROVIDES: Single Compression Double Side-Pull

- 10" high elastic back tapering to velfoam panels
- Designed with double side pulls to provide additional compression to alleviate lower back pain
- 4 flexible polypro boning elements for added support
- Available with a removable foam pad to relieve stress to the lower spine or removable gel-pack
- Adjustable velcro fastener for comfortable fit
- Latex-free
- Universal sizing

STANDARD SIZE

Size	Fits	W/ Pad	W/ Gel
Small	21" - 26"	5000-S	5000G-S
Regular	26" - 36"	5000-R	5000G-R
X-Large	36" - 46"	5000-XL	5000G-XL
2XL	46" - 56"	5000-2XL	5000G-2XL



5000



Lumbar Sacral Support DCSO CSA

PROVIDES: Dual Compression Single Overlapping

- 10" high all elastic back tapering to 6" front elastic panels
- Single overlapping belt provides additional abdominal support
- All elastic construction enfolds body contours comfortably
- 4 flexible polypro boning elements for added support
- Available with 4 removable steel boning elements (white only)
- Adjustable velcro fastener for comfortable fit
- Available white or black
- Latex-free

STANDARD SIZE

Size	Fits	White	Black	W/ 4 Steels
Small	26" - 30"	5500-S	5500BK-S	5502-S
Medium	30" - 34"	5500-M	5500BK-M	5502-M
Large	34" - 38"	5500-L	5500BK-L	5502-L
X-Large	38" - 42"	5500-XL	5500BK-XL	5502-XL
2XL	42" - 46"	5500-2XL	5500BK-2XL	5502-2XL



5500



Made in the USA



Orthopedic & Rehabilitative
Lumbosacral



5700

Posture Corrective Brace CSA

Posture Corrective Brace ensures comfort while effectively restoring a healthier stature. It adapts to your body shape and serves as an excellent aid for those with osteoporosis and postural disturbances.

- Soft non-elastic, over the shoulder straps help correct faulty posture
- Hook and loop closure easily adjusts to increase or decrease the amount of support and pressure
- Inner protector fabric wicks away moisture and keeps back dry
- Latex-free

STANDARD SIZE

Size	Fits	Model
Universal	22" - 46"	5700



8310

Universal Maternity Support CSA

NYOrtho Universal Maternity Support helps alleviate lower back pain due to pregnancy by supporting the abdominal and lumbar regions. Fully adjusts to accommodate abdominal growth throughout pregnancy. Elastic side panels add compression and ventilation. Hides well under clothing.

- Medical foam body applies over abdomen for optimum comfort
- Plush elastic side panels for comfortable compression
- Measurement based on dress size before pregnancy.
- Adjustable velcro fastener for comfortable fit
- Universal sizing
- Latex-free

CAUTION: Please consult your physician before wearing this product.

STANDARD SIZE

Size	Fits	Model
Universal	6-14	8310-U



5075

Universal Trochanter Belt CSA

PROVIDES: Stabilize pelvis and SI joint

A trochanter belt is a supportive brace that can help alleviate pain, reduce inflammation and restore function. This effective device is designed to stabilize the pelvis and prevent excessive movement of the SI joint.

- 3" non-stretch cotton webbing hugs the hips
- Durable easy to use, latex-elastic tension straps
- Gripper webbing interior maintains proper positioning
- Adjustable velcro fastener for comfortable fit
- Universal sizing

STANDARD SIZE

Size	Fits	Model
XS/Small	20" - 30"	5075-S
Medium/Large	30" - 40"	5075-R
X-Large/2XL	40" - 50"	5075-XL



Occupational Safety

Back Belts

Occupational Safety

Back injuries are still the most significant occupational health problem and thousands of workers use supports everyday as part of a complete approach to reducing the severity & frequency back injuries. NYOrtho offers a comprehensive line of occupational/ergonomic products for a wide variety of applications. Occupational back belts provide adjustable comprehensive support to help prevent the discomforts of low back pain via stabilizing lumbar, sacral, abdominal muscles and ligaments, relieving stress on the lower spine.

Elastic Back Belt CSA

- 8" high all elastic back tapering to velcro loop front panels
- 5" outer-belt provides additional compression to abdominal area
- 6 flexible polypro boning elements for added support
- Inner foam layer for extra comfort
- 1½" adjustable knit suspenders
- Universal sizing

STANDARD SIZE

Model	Fits	Size
6025-S	28" - 33"	Small
6025-M	32" - 38"	Medium
6025-L	37" - 46"	Large
6025-XL	44" - 52"	X-Large
6025-2XL	51" - 59"	2XL



6025



Breathable Spandex Back Belt CSA

- 8" high breathable spandex back tapering to velcro loop front panels
- 4" double outer-belt provides additional compression to abdominal area
- 4 flexible polypro boning elements for added support
- Interior gripper webbing prevents belt from sliding
- Inner foam layer for extra comfort
- 1½" removable adjustable knit suspenders
- Standard sizing

STANDARD SIZE

Model	Fits	Size
6027-S	26" - 30"	Small
6027-M	30" - 34"	Medium
6027-L	34" - 38"	Large
6027-XL	38" - 42"	X-Large
6027-2XL	42" - 46"	2XL



6027

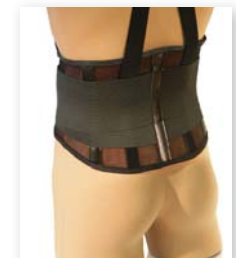

Deluxe Breathable Spandex Back Belt CSA

- 9" high breathable spandex back tapering to velcro loop front panels
- Vinyl reinforced side-pulls
- 4" double outer-belt provides additional compression to abdominal area
- 4 flexible polypro boning elements for added support
- Interior gripper webbing prevents belt from sliding
- 1½" adjustable suspenders
- Available in Black or **Reflective**
- Standard sizing

Reflective	Black	Fits	Size
6800RF-S	6800BK-S	26" - 30"	Small
6800RF-M	6800BK-M	30" - 34"	Medium
6800RF-L	6800BK-L	34" - 38"	Large
6800RF-XL	6800BK-XL	38" - 42"	X-Large
6800RF-2XL	6800BK-2XL	42" - 46"	2XL



6800BK



6800RF

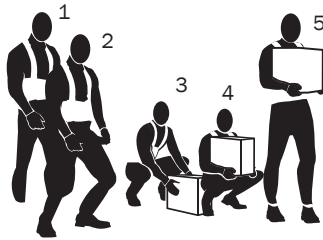

Good Lifting Technique ✓

- 1 - SIZE UP THE LOAD & ESTABLISH A FIRM FOOTING
- 2 - KEEP YOUR BACK STRAIGHT
- 3 - BEND AT YOUR KNEES
- 4 - LIFT WITH YOUR LEGS
- 5 - STEP IN THE DIRECTION YOU ARE MOVING



Occupational Safety Supports



7100

Deluxe Velfoam Back Belt CSA

- 9" high all elastic back tapering to velfoam front-panels
- 4" double outer-belt provides additional compression to abdominal area
- 6 flexible polypro boning elements for added support
- Inner foam layer for extra comfort
- 1½" adjustable non-stretch suspenders
- Standard sizing

STANDARD SIZE

Size	Fits	Model
Small	26" - 30"	7100-S
Medium	30" - 34"	7100-M
Large	34" - 38"	7100-L
XL	38" - 42"	7100-XL
2XL	42" - 46"	7100-2XL

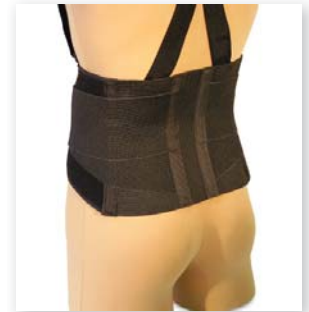

7505

Deluxe Elastic Back Belt CSA

- 9" high elastic back tapering to 6" elastic front-panels
- Overlapping 4" single outer-belt provides additional compression to abdominal area
- Available in a low-profile, 6" back tapering to 4" elastic front-panels and 3" overlapping single outer-belt
- 4 flexible polypro boning elements for added support
- Interior gripper webbing prevents belt from sliding
- Available in a breathable ventilated elastic for comfort with a **reflective option**
- 1½" adjustable suspenders
- Standard sizing

STANDARD SIZE

Black	Ventilated	Ventilated Reflective	Low Profile Black	Fits	Size
7350-S	7505-S	7505RFL3-S	7352-S	26" - 30"	Small
7350-M	7505-M	7505RFL3-M	7352-M	30" - 34"	Medium
7350-L	7505-L	7505RFL3-L	7352-L	34" - 38"	Large
7350-XL	7505-XL	7505RFL3-XL	7352-XL	38" - 42"	XL
7350-2XL	7505-2XL	7505RFL3-2XL	7352-2XL	42" - 46"	2XL



7505RFL



Occupational Safety Supports



9330

Tennis Elbow Support

RECOMMENDATION: For relief of inflammation of the tendons of the elbow caused by overuse of the muscles of the forearm.

- Provides comfortable support to the forearm
- Velfoam padding wicks away moisture
- Adjustable velcro closure for custom fit
- Universal sizing and ambidextrous

STANDARD SIZE

Model	Size
9330	Universal



9409

Wrist Brace

RECOMMENDED USE: Support to injured, weak, or post-cast wrists requiring rigid stabilization. Ideal for carpal tunnel syndrome and wrist sprains.

- Ideal for carpal tunnel syndrome and wrist sprains
- Breathable and durable lycra lined padding wicks away moisture
- Easy to apply slip-on support with tension straps
- Allows full finger function
- Removable adjustable palmar stay
- 8" length

STANDARD SIZE

Left	Right	Fits	Size
9409L-S	9409R-S	5½" - 6½"	Small
9409L-M	9409R-M	6½" - 7½"	Medium
9409L-L	9409R-L	7½" - 8½"	Large
9409L-XL	9409R-XL	8½" +	X-Large



9450-NV, 9450-BK

Elastic Wrist Wrap CSA

RECOMMENDED: Helps support weak or sore wrists.

STANDARD SIZE

Thumb Loop	Wrap Only	Color
9450-BK	9460-23	Black
9450-NV	N/A	Navy

- Durable 3" elastic for support and comfort
- Thumb loop for ease of application
- Adjustable strap for custom fit and level of support
- Available without thumb loop (9460)
- Universal sizing and ambidextrous



9460-23



9490

Elastic Hand & Wrist Support W/Stay

RECOMMENDED: Ideal for carpal tunnel syndrome and wrist sprains.

STANDARD SIZE

Right-Hand	Left-Hand	Size
9490-SR	9490-SL	Small
9490-MR	9490-ML	Medium
9490-LR	9490-LL	Large
9490-XLR	9490-XLL	XL
9490-2XLR	9490-2XLL	2XL

- Single strap support with center stay limits downward wrist movements
- Two-stage hook and loop closure for custom fit and support
- Made of durable elastic

Slip-On Circular Knit Supports

RECOMMENDED: Helps relieve pain from minor injuries, weak joints and reduces swelling due to arthritis, swelling or tendonitis.



Occupational
Safety
Supports



9300 , 9400

Slip-on Circular Knit Supports provide light compression support and therapeutic heat retention to help relieve symptoms associated with minor sprains, strains, and arthritis. Comfortable for all day wear.

- Helps provide compression, relief and protection
- Sleek sleeve design follows natural shape of body and is discreet under clothing
- Dual-stretch power knit material for optimal fit and comfort
- Designed for all-day comfort with soft, lightweight, breathable materials
- Easy to put on and take off
- Ambidextrous

STANDARD SIZE

Model	Type	Fits	Size
9000-S	Slip-On Knee Support 12¼" Long	12" - 15"	Small
9000-M	Slip-On Knee Support 12¼" Long	15" - 18"	Medium
9000-L	Slip-On Knee Support 12¼" Long	18" - 21"	Large
9000-XL	Slip-On Knee Support 12¼" Long	21" - 24"	XL
9000H-S	Slip-On Knee Support 12¼" Long W/Patella Hole	12" - 15"	Small
9000H-M	Slip-On Knee Support 12¼" Long W/Patella Hole	15" - 18"	Medium
9000H-L	Slip-On Knee Support 12¼" Long W/Patella Hole	18" - 21"	Large
9000H-XL	Slip-On Knee Support 12¼" Long W/Patella Hole	21" - 24"	XL
9050-S	Slip-On Knee Support 8" Long	12" - 15"	Small
9050-M	Slip-On Knee Support 8" Long	15" - 18"	Medium
9050-L	Slip-On Knee Support 8" Long	18" - 21"	Large
9050-XL	Slip-On Knee Support 8" Long	21" - 24"	XL
9200-S	Slip-On Ankle Support	7" - 8"	Small
9200-M	Slip-On Ankle Support	8" - 9"	Medium
9200-L	Slip-On Ankle Support	9" - 10"	Large
9200-XL	Slip-On Ankle Support	10" - 11"	X-Large
9300-S	Slip-On Elbow Support	9" - 10"	Small
9300-M	Slip-On Elbow Support	10" - 11"	Medium
9300-L	Slip-On Elbow Support	11" - 12"	Large
9300-XL	Slip-On Elbow Support	12" - 14"	XL
9400-S/M	Slip-On Wrist Support	6" - 8"	Small / Medium
9400-L/XL	Slip-On Wrist Support	8" - 10"	Large / XL



9000, 9000H, 9050, 9200

Abdominal Binders			
Tapered Abdominal Binders	43		
Universal Abdominal Binders.....	43-44		
Abduction Wedge	39		
Ankle Supports, Slip-On	51		
Arm Slings			
Envelope Arm Sling, Metal	39		
Envelope Arm Sling, Velcro	39		
Shoulder Immobilizer	38		
Velpeau Arm Sling.....	38		
Belts			
Breathable Spandex Back Belt	48		
Dix Breathable Spandex Belt.....	48		
Dix Breathable Spandex Belt, RFL	48		
Deluxe Elastic Back Belt	49		
Deluxe Velfoam Back Belt	49		
Elastic Back Belt	48		
Elastic Back Belt, Low Profile	48		
Elastic Back Belt, Ventilated	48		
Elastic Back Belt, Ventilated RFL	48		
Deluxe Gait Belt.....	40		
Quick-Release Gait Belts.....	40		
Metal Buckle Gait Belts.....	41		
Rib Belt.....	44		
Bariatric			
APEX Foam Cushion	11		
APEX Gel-Foam Cushion	11		
APEX Quad Gel-Foam Cushion	11		
Bariatric Foam Cushion.....	16		
Bariatric Gel-Foam Cushion.....	16		
Quilted Heel Protectors	7-8		
Zero-G Boot	5		
Zero-G Boot AIR	4		
Zero-G Performa Boot	5		
Bed Accessories			
Bed Pads, Sheepskin	35		
Bed Rail Pads, Cushioned Top	34		
Bed Rail Pads, Sheepskin.....	34		
Bed Rail Pads, Split Rail.....	34		
Bed Rail Pads, Vinyl	34		
Bedside Safety Mats.....	32-33		
Beveled Edge Safety Mats	32-33		
FALLShield Bedside Safety Mat.....	32		
Gap Guard	35		
Pillows	36-37		
Repositioning Slide.....	35		
Roll Control Bolster	35		
Tri-Fold Bedside Safety Mat	33		
Wedge, Bariatric Positioning	36		
Wedge, Elevating.....	36		
Wedge, Positioning	36		
Cervical Supports			
Cervical Collars	42		
Cervical Roll Pillow	37		
Comfort Cradle	37		
Double Lobe Cervical Pillow	37		
Circular Knit Supports			
Ankle Supports, Slip-On.....	51		
Elbow Supports, Slip-On.....	51		
Knee Supports, Slip-On	51		
Wrist Supports, Slip-On	51		
Cushions, APEX			
Anti-Thrust Foam Cushion	10		
Anti-Thrust Gel-Foam Cushion.....	10		
Bariatric Foam Cushion.....	11		
Bariatric Gel-Foam Cushion.....	11		
Bariatric Quad Gel-Foam Cushion	11		
Coccyx Gel-Foam Cushion	12		
Foam Cushion.....	11		
Gel-Foam Cushion.....	11		
Pommel Gel-Foam Cushion	12		
Quad Gel-Foam Cushion.....	11		
Waveform Gel-Foam Cushion	12		
Wedge Foam Cushion.....	11		
Wedge Gel-Foam Cushion.....	11		
Wedge Pommel Gel-Foam Cush	12		
Cushions, APEX CORE			
Anti-Thrust Foam Cushion	15		
Anti-Thrust Gel-Foam Cushion.....	15		
Coccyx Gel-Foam Cushion	14		
Coccyx Pommel Gel-Foam Cush	14		
Gel-Foam Cushion.....	13		
Gel-Infused Memory Foam Cush	15		
Leg Abductor Gel-Foam Cushion	14		
Pommel Gel-Foam Cushion	14		
Wedge Foam Cushion.....	13		
Wedge Gel-Foam Cushion.....	13		
Wedge Pommel Gel-Foam Cushio	13		
Cushions			
Bariatric Foam Cushion.....	16		
Bariatric Gel-Foam Cushion.....	16		
Convuluted Gel-Foam Cushion	17		
Foam Cushion.....	16		
Gel-Foam Cushion.....	16		
Independent Cell Foam Cushion.....	16		
Lumbar Cushion	37		
Pommel Foam Cushion	17		
Pommel Gel-Foam Cushion	17		
Post Hip Surgery Cushion	39		
Sure-Check Cushion	18		
Tri-Foam Cushion.....	17		
Visco Foam Cushion	19		
Wedge Foam Cushion.....	16		
Wedge Gel-Foam Cushion.....	16		
Wedge Pommel Foam Cushion.....	17		
Wedge Pommel Gel-Foam Cush	17		
Derma Shield	9		
Door Guard.....	31		
Door Guard, Alarm	31		
Elbow Supports, Slip-On	51		
FALLShield Bedside Safety Mat	32		
Fetal Monitoring Belts	42		
Gait Belts			
Deluxe Gait Belt.....	40		
Quick-Release Gait Belts.....	40		
Metal Buckle Gait Belts.....	41		
Gap Guard	35		
Geri-Chair Accessories			
Comfort Seats	20-22		
METRIS Comfort Seat	20		
Smoker's Apron, Oversized	26		
ULTRA-LIFT Comfort Seat.....	20		
Heel Protectors			
Quilted Elbow Protector.....	8		
Quilted Heel Protectors	7-8		
Quilted Long Boot.....	8		
Sheepskin Boot.....	9		
Sheepskin Heel Protector.....	9		
Zero-G Boot	5		
Zero-G Boot AIR	4		
Zero-G Heel Pillow	6		
Zero-G Heel Pillow Ultra	6		
Zero-G Performa Boot	5		
Heel Elevation - See Zero-G Series			
Hip Surgery Cushion.....	39		
Knee Separator	39		
Knee Supports, Slip-On.....	51		
Lumbar Sacral Supports			
Lumbar Cushion	37		
Lumbar Orthosis Support.....	45		
LS Support CC	46		
LS Support CC, Gel	46		
LS Support CC, Pad.....	46		
LS Support DCDO, Pad	45		
LS Support DCDO, Steels.....	45		
LS Support DCSO.....	46		
LS Support DCSO, Steels	46		
LS Support SCDS, Gel	46		
LS Support SCDS, Pad.....	46		
Maternity Support	47		
Posture Corrective Brace	47		
Trochanter Belt.....	47		
METRIS Comfort Seat	20		
Oxygen Cylinder Holder, Nylon	26		
Palm Grips	42		
Pillows			
Cervical Roll Pillow	37		
Comfort Cradle	37		
Double Lobe Cervical Pillow	37		
Hospital Pillows.....	36		
Repositioning Slide	35		
Rib Belts.....	44		

Restraints

Cushion Belt	29
Cushion Belt, Pelvic.....	29
Economy Wheelchair Belt	29
Padded Mitts	30
Patient Roll Belt	30
Patient Safety Vest.....	30
Pelvic Holder	30
Sheepskin Limb Holder.....	30
Roll Control Bolster.....	35

Safety Mats

Bedside Safety Mats.....	32-33
Beveled Edge Safety Mats	32-33
FALLShield Bedside Safety Mat.....	32
Tri-Fold Bedside Safety Mat	33

Sheepskin, Imitation

Bed Pads.....	35
Bed Rail Pads	34
Elbow Protector	9
Heel Protector	9
Limb Holder	30
Sheepskin Boot.....	9
Wheelchair Pads	27
Shoulder Immobilizer.....	38
Solid Seat Insert.....	19

Stretcher Pads, Ambulance	31
Sure-Check Cushions	18
Stretcher Pads, ER/OR.....	31

Transfer Belts

Deluxe Gait Belt.....	40
Quick-Release Gait Belts.....	40
Metal Buckle Gait Belts.....	41
Tennis Elbow Support	50
Ultra-Lite Hip Protector	32

ULTRA-LIFT Comfort Seat	20
-------------------------------	----

Wedges, Positioning

Wedge, Bariatric Positioning	36
Wedge, Elevating.....	36
Wedge, Positioning	36

Wheelchair Accessories

Abduction Wedge.....	39
Comfort Seats	22-23
Cushion Belt	29
Cushion Belt, Pelvic.....	29
Economy Wheelchair Belt	29
Footrest Bag.....	24
Footrest Extender	24
Knee Separator.....	39
Lap Cushion, Desk Arm	25

Lap Cushion, Full Arm	25
Lap Cushion, Self-Releasing.....	25
Leg Rest Pad	24
Modesty Apron	26
Oxygen Cylinder Holder, Nylon.....	26
Resident-Release, Cushion Belts.....	28
Resident-Release, Nylon Belts.....	28
Sheepskin Pads.....	27
Smokers Apron, Economy.....	26
Smokers Apron, Deluxe	26
Solid Seat Insert.....	19
Urinary Drain Bag, Canvas.....	27
Urinary Drain Bag, Vinyl	27

Wrist Supports

Hand & Wrist Support W/Stay.....	50
Wrist Brace	50
Wrist Supports, Slip-On.....	51
Wrist Wrap	50
Wrist Wrap, Thumb Loop.....	50

Zero-G Series

Zero-G Boot	5
Zero-G Boot AIR	4
Zero-G Heel Pillow	6
Zero-G Heel Pillow Ultra	6
Zero-G Performa Boot	5

NYOrtho Mailing Address:

63 Flushing Avenue.
Unit 333
Brooklyn, NY 11205

NYOrtho Physical Address:

63 Flushing Avenue.
Building 280, 7th Floor
Brooklyn, NY 11205

Tel: 800.699.2358
Fax: 718.852.4095
email: cs@nyorthousa.com
website: www.nyorthousa.com

NYOrtho Warranty (Limited):

NYOrtho warrants all products to be free of defects in materials and workmanship. NYOrtho will not be obligated to under this warranty for damage as a result of wear and tear or incorrect use/misuse.

Returns:

Merchandise must be in new, saleable condition and in original packaging. No credit will be given for merchandise purchased over six months from the original invoice date. A return authorization code is required before goods may be returned. The invoice number and date of purchase are required for return approval. Contact customer service to obtain an RA# at 800.699.2358. In certain cases, a 15% restocking fee will apply. Customers are responsible for shipping products back to

the NYOrtho physical address. Due to infection control regulations, certain items may not be returned

Order Discrepancies:

Upon examination of your order, if you find an error was made, call customer service immediately and we will provide you with assistance. All shipping discrepancies and damaged package claims will be honored when communicated to NYOrtho within 10 working days from the receipt of product.



INDEX - NUMERICAL

1000	45	9503P-60	41	9526	25	9579-032472	33
2000	45	9503P-72	41	9527-1620-3	25	9579-033072	33
3009	46	9503N-54	41	9527-2022-3	25	9579-042460	33
4000	46	9503N-60	41	9528-18-3	25	9579-043668	33
4000G	46	9503N-72	41	9530	26	9579BV-012466	33
5000	46	9503S-60	41	9531	26	9579TR-1H2472	33
5000G	46	9503W-54	41	9532	26	9580-26H75	35
5075	47	9503W-60	41	9540	26	9580-3475	35
5500	46	9503W-72	41	9546	26	9590-151504	39
5502	46	9504-54	41	9547	24	9593-161602	18
5610	45	9504-60	41	9547-22	24	9593-161603	18
5700	47	9504-72	41	9547-24	24	9593-181602	18
6025	48	9505P-54	40	9548-1620-1	24	9593-181603	18
6027	48	9505P-60	40	9548-1620-2	24	9593-201602	18
6800	48	9505P-72	40	9548-2224-1	24	9593-201603	18
7100	49	9505W-54	40	9548-2224-2	24	9593-GEL-161602	18
7350	49	9505W-60	40	9548B-1620	24	9593-GEL-161603	18
7352	49	9505W-72	40	9548B-2224	24	9593-GEL-181602	18
7505	49	9506-54	40	9549	27	9593-GEL-181603	18
8000	43	9506-60	40	9550	27	9593-GEL-201602	18
8100	43	9506-72	40	9552	27	9593-GEL-201603	18
8101	43	9507	40	9553	27	9593-VSC-181603	19
8130	44	9509-A	9	9554	27	9593B-161602	18
8132	44	9509-B	9	9555	27	9593B-161603	18
8134	44	9509-C	30	9556	27	9593B-181602	18
8140	43	9510	7	9557-24	34	9593B-181603	18
8142	43	9510L	7	9557-30	34	9593B-201602	18
8144	43	9511	7	9557-34	34	9593B-201603	18
8200	44	9511L	7	9557-42	34	9593B-GEL-161602	18
8210	44	9514	7	9557-48	34	9593B-GEL-161603	18
8310	47	9514-GP	7	9557-56	34	9593B-GEL-181602	18
8500	42	9514L	7	9557-60	34	9593B-GEL-181603	18
8600	42	9514L-GP	7	9557-72	34	9593B-GEL-201602	18
8700	38	9515	8	9560-2430	35	9593B-GEL-201603	18
8701	39	9516	8	9560-3040	35	9595-161602	16
8702	39	9516L	8	9560-3060	35	9595-161603	16
8712	38	9517	9	9560-4880	35	9595-181602	16
9000	51	9518	5	9565-010928-S	34	9595-181603	16
9000H	51	9518AIR	4	9565-011124	34	9595-201602	16
9050	51	9518P	5	9565-011134	34	9595-201603	16
9100	9	9518-BAG	4,5	9565-01H1134	34	9595-201802	16
9200	51	9519	23	9565-011169	34	9595-201803	16
9300	51	9519GC	21	9565-011537-C	34	9595-221602	16
9330	50	9519GC-S	21	9565-011550-C	34	9595-221603	16
9360	8	9519L	23	9567-35	35	9595-221802	16
9370	30	9519XL	23	9567-70	35	9595-221803	16
9371	30	9520	23	9570-022460	33	9595-241802	16
9400	51	9520GC	21	9570-022466	33	9595-241803	16
9402	9	9520GC-S	21	9570-022472	33	9595-281802	16
9409	50	9520L	23	9570-023668	33	9595-281803	16
9450	50	9520XL	23	9570-032466	33	9595-CGL-161603	17
9460-23	50	9521	23	9570-032472	33	9595-CGL-181603	17
9490	50	9521GC	21	9570-033072	33	9595-CGL-201803	17
9503C-54	41	9521GC-S	21	9570-042460	33	9595-GEL-161602	16
9503C-60	41	9521L	23	9570-043668	33	9595-GEL-161603	16
9503C-72	41	9521XL	23	9576-012470	32	9595-GEL-181602	16
9503F-54	41	9522	22	9577	31	9595-GEL-181603	16
9503F-60	41	9522GC	22	9578	31	9595-GEL-201602	16
9503F-72	41	9522GC-GEL	20	9579-022460	33	9595-GEL-201603	16
9503L-54	41	9522GC-S	22	9579-022466	33	9595-GEL-201802	16
9503L-60	41	9522L	22	9579-022472	33	9595-GEL-201803	16
9503L-72	41	9522XL	22	9579-023668	33		
9503P-54	41	9523GC-GEL	20	9579-032466	33		

9595-GEL-221602.....	16	9597-221802	11	9597B-GEL-242003.....	11	9693	29
9595-GEL-221603.....	16	9597-4GEL.....	11	9597B-GEL-242004.....	11	9696	30
9595-GEL-221802.....	16	9597-ATG-181642	10	9597B-GEL-261803.....	11	9697	30
9595-GEL-221803.....	16	9597-ATG-201642	10	9597B-GEL-261804.....	11	9699	30
9595-GEL-241802.....	16	9597-ATH-181642	10	9597B-GEL-281803.....	11	9700	29
9595-GEL-241803.....	16	9597-ATH-201642	10	9597B-GEL-301903.....	11	9700-L	29
9595-GP-161602	17	9597-4GEL-161602.....	11	9599-AGL-181603.....	14	9700S	29
9595-GP-161603	17	9597-4GEL-161603.....	11	9599-ATG-181642	15	9701	29
9595-GP-181602	17	9597-4GEL-181602.....	11	9599-ATG-201642	15	9702	29
9595-GP-181603	17	9597-4GEL-181603.....	11	9599-ATH-181642	15	9703	28
9595-GP-181803	17	9597-4GEL-201602.....	11	9599-ATH-201642	15	9704	28
9595-GP-201603	17	9597-4GEL-201603.....	11	9599-G-181603	13	9705	28
9595-GP-201802	17	9597-4GEL-201802.....	11	9599-G-201603.....	13	9706	28
9595-GP-201803	17	9597-4GEL-201803.....	11	9599-G-201803.....	13	9710-42.....	28
9595-GWP-161642	17	9597-4GEL-221802.....	11	9599-G-221603.....	13	9716	28
9595-GWP-181642	17	9597-4GEL-221803.....	11	9599-G-221803.....	13	9797	31
9595-IC-181603	16	9597-GC-161603	12	9599-G-241603.....	13	9797-ALRM.....	31
9595-IC-181803	16	9597-GC-181603	12	9599-G-241803.....	13	9801-R	42
9595-IC-201603	16	9597-GC-201603.....	12	9599-G-261803.....	13	9801-L	42
9595-P-161602	17	9597-GEL-161602.....	11	9599-G-281803.....	13	9820-96.....	39
9595-P-161603	17	9597-GEL-161603.....	11	9599-G-301803.....	13	9820-97.....	39
9595-P-181602	17	9597-GEL-181602.....	11	9599-GC-161603	14	9900	6
9595-P-181603	17	9597-GEL-181603.....	11	9599-GC-181603	14	9901	6
9595-P-181803	17	9597-GEL-201602.....	11	9599-GC-181803	14	9902	6
9595-P-201603	17	9597-GEL-201603.....	11	9599-GC-201603.....	14	9910-161105	36
9595-P-201802	17	9597-GEL-201802.....	11	9599-GC-201803.....	14	9910-161207	36
9595-P-201803	17	9597-GEL-201803.....	11	9599-GC-221603.....	14	9910-170808	36
9595-TRI-181604	17	9597-GEL-221802.....	11	9599-GC-221803.....	14	9910-221108	36
9595-VSC-181603	19	9597-GEL-221803.....	11	9599-GCP-181603	14	9910-241207	36
9595-W-161642	16	9597-GEL-241802.....	11	9599-GCP-201603	14	9910-281082	36
9595-W-181642	16	9597-GEL-241803.....	11	9599-GCP-221603	14	9910-341207	36
9595-W-201642	16	9597-GLC-181602	12	9599-GCP-221803	14	9911-242407	36
9595-W-201842	16	9597-GLC-181603	12	9599-GIM-181603	15	9911-242412	36
9595-W-221642	16	9597-GLC-201602	12	9599-GP-161603	14	9912	35
9595-W-221842	16	9597-GLC-201603	12	9599-GP-181603	14	9960	32
9595-WGL-161642.....	16	9597-GLC-221602	12	9599-GP-181803	14	9-SSI-1616	19
9595-WGL-181642.....	16	9597-GLC-221603	12	9599-GP-201603	14	9-SSI-1816	19
9595-WGL-201642.....	16	9597-GP-161603	12	9599-GP-201803	14	9-SSI-2016	19
9595-WGL-201842.....	16	9597-GP-181603	12	9599-GP-221603.....	14	9-SSI-2218	19
9595-WGL-221642.....	16	9597-GP-181803	12	9599-GW-161642	13	9-SSI-2416	19
9595-WGL-221842.....	16	9597-GP-222003	12	9599-GW-181642	13	9-SSI-2616	19
9595-WP-161642	17	9597-GP-241803	12	9599-GW-201642	13	9-SSI-2618	19
9595-WP-181642	17	9597-GP-242003	12	9599-GWP-161642	13	FA-GEL-4x8.....	4,5
9595B-221804	16	9597-GWP-181642	12	9599-GWP-181642	13	VSC-181603-SC.....	19
9595B-222004	16	9597-VSC-181603	19	9599-GWP-201642	13		
9595B-302003	16	9597-W-161642	11	9599-GWP-221642	13		
9595B-GEL-201803.....	16	9597-W-181642	11	9599-GWP-221842	13		
9595B-GEL-201804.....	16	9597-W-181842	11	9599-W-161642	13		
9595B-GEL-241803.....	16	9597-W-201642	11	9599-W-181642	13		
9595B-GEL-241804.....	16	9597-W-201842	11	9599-W-201642	13		
9595B-GEL-261803.....	16	9597-WGL-161642	11	9600	37		
9595B-GEL-261804.....	16	9597-WGL-181642	11	9601	37		
9595B-GEL-281803.....	16	9597-WGL-181842	11	9606	37		
9595B-GEL-281804.....	16	9597-WGL-201642	11	9620-1824	36		
9595B-GEL-301803.....	16	9597-WGL-201842.....	11	9620-2026	36		
9595B-GEL-301804.....	16	9597B-221803	11	9620-2030	36		
9595B-GEL-302003.....	16	9597B-241803	11	9624-1824	36		
9595B-GEL-302004.....	16	9597B-261803	11	9624-2026	36		
9597-161602	11	9597B-4GEL-241804	11	9624-2030	36		
9597-161603	11	9597B-4GEL-262003.....	11	9630	37		
9597-181602	11	9597B-4GEL-301803.....	11	9640	37		
9597-181603	11	9597B-4GEL-302203.....	11	9650	42		
9597-201803	11	9597B-GEL-241803.....	11	9651	42		

NYOrtho

63 FLUSHING AVENUE • BROOKLYN, NEW YORK 11205



PEDIC & REHABILITATIVE • ABDOMINAL BINDERS & RIB BELTS • LUMBAR SACRAL SUPPORTS • THERAPY & AMBULATION
& POSITIONING • WHEELCHAIR CUSHIONS & OVERLAYS • PATIENT SAFETY & FALL MANAGEMENT • ALARMS & FALL
PREVENTION MANAGEMENT • HEEL & ELBOW PROTECTORS • SKIN SHIELDS • ZERO-G PRODUCTS • OCCUPATIONAL
SAFETY DEVICES • ABDOMINAL BINDERS & RIB BELTS • LUMBAR SACRAL SUPPORTS • THERAPY & AMBULATION • ARM SLINGS • GAIT TRANSFER
AIDS • WHEELCHAIR CUSHIONS & OVERLAYS • PATIENT SAFETY & FALL MANAGEMENT • ALARMS • BEDSIDE SAFETY MATS • RESTRAINTS