

SENSOR PAD SETUP

Sensor Pad Setup for BedPro Early Warning UnderMattress System (contd.)

- Pass sensor cable under headboard and tuck it under the Cable Strain-Relief tab before inserting the plug into the Modular Connection (Illustration H). The strain-relief tab prevents the plug from being accidentally dislodged and damaged. Be certain to keep cable away from side rails and out of resident's reach. Keep cord away from side rails and out of resident's reach.
 - Place sensor pad on bed.
 - Sensor pad may be cleaned with a damp cloth and mild cleanser. Do not immerse pad in water or cleaning solution. Do not sterilize.
 - Inspect pad before each use. Replace if damaged.
- Read "Warnings" on sensor pad

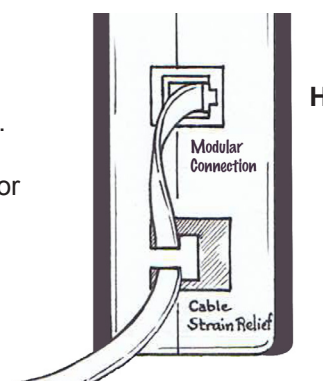

Important: This UnderMattress sensor is designed to work with most mattresses and beds. However, due to differences in mattress construction, bed designs, and resident weight, this sensor pad may not work in all situations. Be certain to evaluate the alarm system's operation for each bed and resident. If it does not work, you may want to consider Skil-Care's BedPro OverMattress sensor pad.

Proceed to "System Operation" on page 6. See page 6 for information about ordering replacement sensor pads.

SENSOR PAD SETUP

BedPro™ OverMattress Safety Alarm

Reorder#	Description	Unit
909310	BedPro OverMattress Safety Alarm with 10"x30" Sensor Pad - 45 Days	Set
909311	BedPro OverMattress Safety Alarm with 10"x30" Sensor Pad - 180 Days	Set

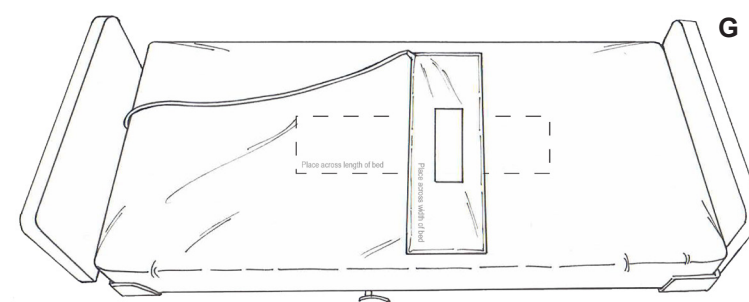

Sensor Pad Setup for BedPro OverMattress System

- Remove bed sheet and place sensor pad across width or length of bed (Illustration G).
- Position connector cable toward headboard. The opposite end must be positioned below the resident's pelvis.
- Pass sensor cable under headboard and tuck it under the Cable Strain-Relief tab before inserting the plug into the Modular Connection (Illustration H). The strain-relief tab prevents the plug from being accidentally dislodged and damaged. Be certain to keep the cable away from side rails and out of resident's reach. Keep cord away from side rails and out of resident's reach.
- Cover mattress and sensor pad with sheet.
- Sensor pad may be cleaned with a damp cloth and mild cleanser. Do not immerse pad in water or cleaning solution. Do not sterilize.
- Inspect pad before each use.

Read "Warnings" on sensor pad

Proceed to "System Operation" on page 6. See page 6 for information about ordering replacement sensor pads.

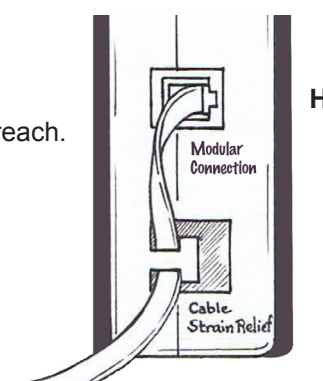

[Click here to view detailed product descriptions and prices.](#)

Call 800-397-5899 to order today!

SYSTEM OPERATION

System Operation for when the BedPro UnderMattress, Early Warning UnderMattress or OverMattress sensor pads have been properly installed.

Whenever the alarm is initiated, pressing the "Auto-Reset" button on top of the alarm unit will silence it. Pressing this button puts the system into stand-by mode. The system will automatically go into monitoring mode when you put your resident to bed. There's no need to remember to turn the system on. Skil-Care recommends the following procedure for using the BedPro UnderMattress, Early Warning UnderMattress and OverMattress Safety Alarm System.

- Press "Power Test" button before putting resident to bed. If "In-Room Alarm" switch is set to the "Hi or Low" position, the alarm signal will sound and the LED will flash while the button is held down. If the "In-Room" switch is to the "Off" position, the LED will flash while the button is held down. If the LED and/or alarm signal are not activated when the button is pressed, check the power source connections. If alarm is on battery, replace both AA batteries. Do not use alarm system if pressing "Power Test" button cannot activate LED and/or alarm signal.
- Place resident in bed. The LED should flash indicating that the alarm is in the monitoring mode. If LED does not flash, remove resident from the bed and examine sensor pad. If pad is damaged, replace it. Do not use alarm system if LED does not flash when resident is in bed.
- If alarm is set to signal both at bedside and at the nurse's station, select the preferred sound option using the selector switch on the top of the alarm unit. Adjust the high/low toggle on the back.
- If your resident leaves the bed and then returns, the alarm will silence and the system will reset itself. Be certain to visit the resident to make sure he/she is safe.
- Press the "Auto-Reset" button after you have removed your resident from the bed. This will place the system in the stand-by mode.

Keep a copy of these instructions in your procedures manual. If you require extra copies of these instructions, call Skil-Care at 1-800-431-2972 or go to skil-care.com and click on "Product-Use Instructions."

BedPro™ Replacement Sensor Pads

All BedPro replacement sensor pads are available from your medical products supplier. All BedPro sensor pads may also be used with Skil-Care's new MultiPro Alarm

UnderMattress Replacement Sensor Pads

Reorder#	Size	Reorder#	Size	Guarantee	Unit
909325	10" x 30"	909328	20" x 30"	90 Days	Ea.
909326	10" x 30"	909329	20" x 30"	90 Days	5/pk
909327	10" x 30"	909330	20" x 30"	90 Days	10/pk
909331	10" x 30"	909337	20" x 30"	180 Days	Ea.
909332	10" x 30"	909338	20" x 30"	180 Days	5/pk
909333	10" x 30"	909339	20" x 30"	180 Days	10/pk
909401	10" x 30"	909403	20" x 30"	One Year	Ea.
909402	10" x 30"	909404	20" x 30"	One Year	10/pk
909345	For Light Mattresses 39-42lbs.			Two Years	Ea.

OverMattress Replacement Sensor Pads

Reorder#	Guarantee	Reorder#	Guarantee	Size	Unit
909314	45 Days	909317	180 Days	10" x 30"	Ea.
909315	45 Days	909318	180 Days	10" x 30"	5/pk
909316	45 Days	909319	180 Days	10" x 30"	10/pk

Early Warning UnderMattress Replacement Sensor Pads

Reorder#	Guarantee	Reorder#	Guarantee	Length	Unit
909304	90 Days	909307	180 Days	30"	Ea.
909305	90 Days	909308	180 Days	30"	5/pk
909306	90 Days	909309	180 Days	30"	10/pk

You may also order the BedPro Alarm Unit with Accessories (nurse-call connector cable, A/C adaptor and Y-connector). See BedPro Alarm Control Unit with Accessories on page 1 for more detail.

BedPro™ UnderMattress Safety Alarm

Reorder#	Description	Unit
909320	BedPro UnderMattress Safety Alarm with 10"x30" Sensor Pad - 90 Days	Set
909321	BedPro UnderMattress Safety Alarm with 20"x30" Sensor Pad - 90 Days	Set
909322	BedPro UnderMattress Safety Alarm with 10"x30" Sensor Pad - 180 Days	Set
909323	BedPro UnderMattress Safety Alarm with 20"x30" Sensor Pad - 180 Days	Set
909340	BedPro UnderMattress Safety Alarm with 10"x30" Sensor Pad - 1 Year	Set
909341	BedPro UnderMattress Safety Alarm with 20"x30" Sensor Pad - 1 Year	Set
909343	BedPro UnderMattress Safety Alarm for Light Mattresses 39-42lbs. - 2 Year	Set

This alarm features an under-mattress sensor pad that is protected against incontinence and wear by the mattress. Unlike sensor pads that are placed on the mattress, the BedPro UnderMattress sensor will not compromise the pressure relieving qualities of the mattress. Placed beneath the mattress, the BedPro sensor pad stays in place to reduce false alarms. This is especially important for restless residents.

BedPro™ Early Warning Under Mattress Safety Alarm

Reorder#	Description	Unit
909301	BedPro Early Warning System with 30-inch-long sensor pad - 90 Days	Set
909302	BedPro Early Warning System with 30-inch-long sensor pad - 180 Days	Set

This alarm system features a unique under-mattress sensor pad that is designed to activate an alarm signal before the resident exits the bed. The diagonally tapered sensor pad initiates the alarm when the resident sits on or moves toward the edge of the bed. Placed beneath the mattress, the sensor will not compromise the pressure relieving qualities of the mattress. The mattress protects the sensor pad against incontinence, resident tampering, and incontinence.

CAUTIONS

- The BedPro Alarm Systems are not substitutes for proper supervision. Staff on a regular basis must monitor fall-risk and wander-risk patients/residents.
- If batteries are used as the source, battery power must be checked each time the alarm is used to monitor the resident. If battery power is weak, the two AA batteries must be replaced. The alarm will sound if batteries are weak.
- The LED should flash when the alarm is powered, and the resident is in bed, on top of the sensor pad. If the LED fails to flash and you are using the A/C adaptor, check connections at wall outlet and alarm unit. If you are using battery power, replace the two AA batteries. If the LED fails to flash after connections have been checked or the batteries replaced, discontinue use of alarm.



BedPro™ OverMattress Safety Alarm

Reorder#	Description	Unit
909310	BedPro OverMattress Safety Alarm with 10"x30" Sensor Pad - 45 Days	Set
909311	BedPro OverMattress Safety Alarm with 10"x30" Sensor Pad - 180 Days	Set

BedPro™ Alarm Control Unit with Accessories

Reorder#	Description	Unit
909334	BedPro Electronic Unit without Accessories	Ea.
909335	BedPro Electronic Unit with Accessories	Set
909336	BedPro Electronic Unit with Accessories	10 Pk

GUARANTEES

The BedPro Safety Alarm Control Unit is replacement guaranteed for one year following the date of purchase

Sensor Pads	45 Day	90 Day	180 Day	1 Year	2 Years
BedPro UnderMattress	✓		✓		
BedPro Early Warning		✓	✓	✓	✓
BedPro OverMattress		✓	✓		

These guarantees cover defects in materials and workmanship under conditions of normal use. Please return defective part to dealer from whom it was purchased. The dealer will send the defective part to Skil-Care and arrange for shipment of a replacement.

BedPro™ Safety Alarm Unit



COMPONENT IDENTIFICATION

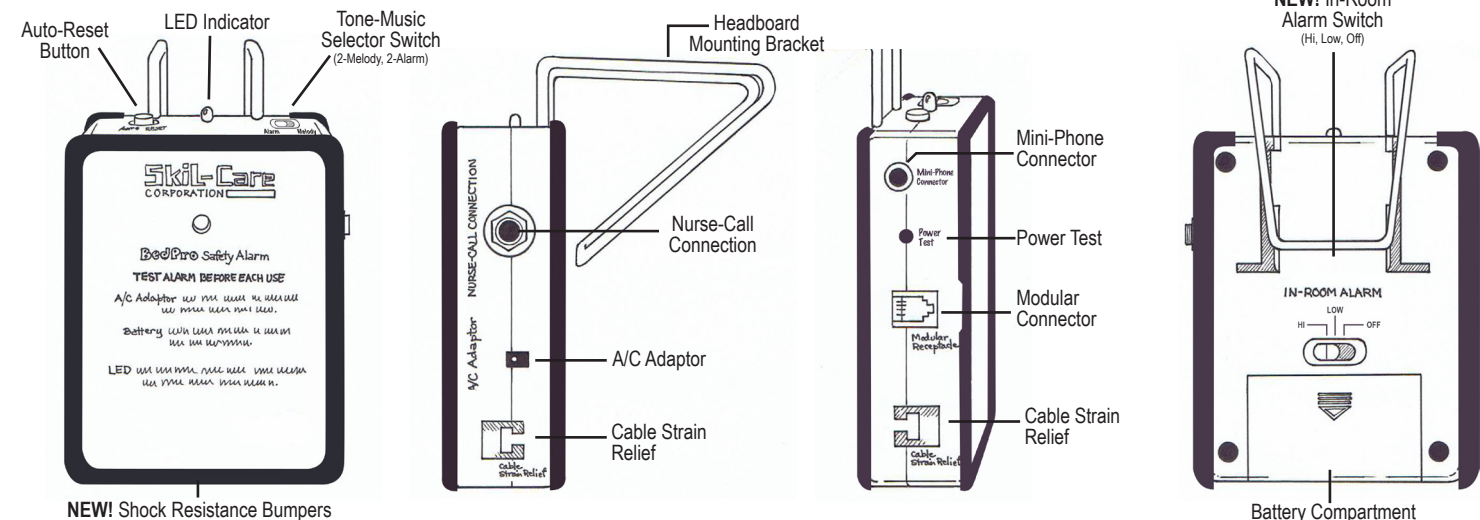

Features:

- **Low battery alert** - alarm sounds when battery is low
- **Sounds** - two tone buzzer, high (90db), low (80db) and two tone melody, high (90db), low (80db)
- Battery Test
- Auto-Reset
- Two Interfaces (connections) - Modular (telephone type) for flat sensors and mini-plug for alternative sensors
- Cable strain relief (2)
- Shock resistance bumpers enhance alarm durability
- A/C Battery Power
- If A/C is plugged in, it will override batteries
- If A/C is plugged in, and power fails batteries will override A/C, if installed

Alarm Conditions

Alarm sounds when resident stands
Alarm sounds when sensor plug is removed (modular & mini-phone), while resident's sitting on sensor
Alarm sounds when modular wire (grey) is cut, while resident is sitting on sensor. Alarm does not sound when auxiliary wire (black) is cut
Alarm sounds when batteries are low

Note: The alarm will not sound when the sensor pad wire (grey) is cut or accidentally pulled out unless it is activated. Also, when the sensor is activated by a resident sitting on it and the plug is accidentally pulled out it will ring but when re-inserted, the alarm will stop ringing. All of the conditions above apply either to the telephone type plug or mini-plug. The alarm sounds only when the mini-plug (black) is removed while sensor is activated. It will not ring when this wire is cut.

INSTALLATION

This information pertains to the BedPro UnderMattress, Early Warning UnderMattress and OverMattress systems

Power Source

- A/C Adaptor**
Tuck A/C adaptor cord under the Cable Strain Relief tab and plug into socket labeled "A/C Adaptor" (Illustration A). Plug adaptor into wall outlet LED will be steady. Test by pressing "Power-Test" button. When testing, make certain that the "In-Room Alarm" switch on the back of the alarm unit is set to the "Hi" or "Low" positions (Illustration B). There will be no audible signal if this switch is in the "Off" position. If alarm doesn't sound, check adaptor connections.
- Battery**
 - Remove battery compartment cover and install two AA batteries LED is steady. Battery operation is recommended only in the event of a power failure. The alarm will automatically switch to battery operation if A/C power fails or if A/C adaptor becomes disconnected.
 - Test battery by pressing the "Power-Test" button on the left side of the alarm unit LED will flash. Check the "In-Room Alarm" switch on the back of the alarm unit which should be set to the "Hi" or "Low" positions (Illustration B). The alarm signal will not sound if the switch is set to the "Off" position. If alarm fails to sound, check battery connections and retest. If alarm still doesn't sound, replace both AA batteries.

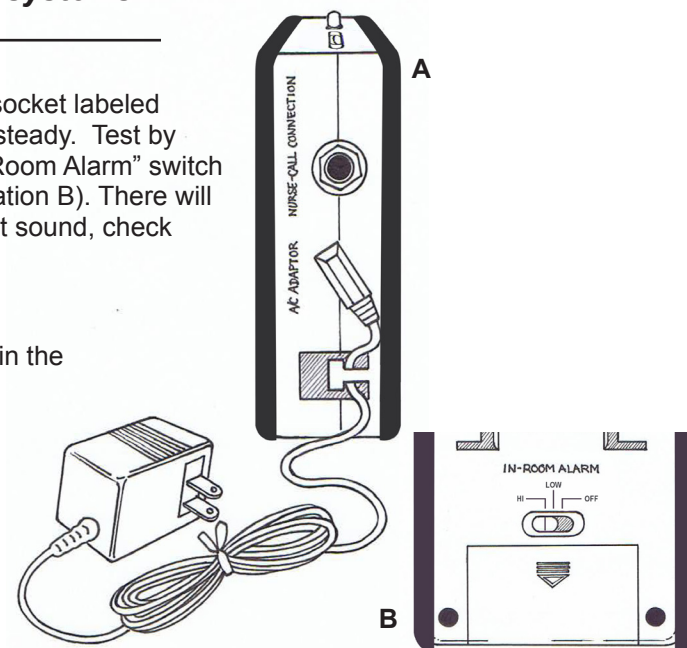

INSTALLATION (contd.)

This information pertains to the BedPro UnderMattress, Early Warning UnderMattress and OverMattress systems

Nurse-Call Interface

The BedPro Safety Alarm is easily connected to the nurse-call system in your facility. It is designed to permit the regular use of the resident's nurse-call button without activating the alarm. You may choose to have the alarm sound at bedside and the nurse's station, or to signal only at the nurse's station. See instructions below.

- Set the "In-Room Alarm" switch on the back of the alarm to the "Hi" or "Low" positions if you want the alarm to sound both at bedside and the nurse's station (Illustration C1). Set the switch to the "Off" position for the alarm to signal only at the nurse's station (Illustration C2).

Important: Set the switch to the "Hi" or "Low" positions when testing the alarm. There will be no audible signal when the "In-Room" switch is set to "Off".

- Inset one end of the supplied nurse-call interface cable into the receptacle labeled "Nurse-Call Connection" located on the right side of the alarm unit (Illustration D). Mount alarm unit on headboard. To prevent resident tampering, alarm unit should face the wall.

- Remove nurse-call button cable from the wall socket and insert Y-connector (Illustration E).

- Plug both the nurse-call button cable and the alarm nurse-call interface cable into the Y-connector (Illustration F). Test operation of both the resident's nurse-call button and the alarm unit's nurse-call interface by:

- Pressing resident's nurse-call button and verifying that the signal is received at nurse's station; and
- Pressing "Power-Test" button on the left side of the alarm unit and verifying that the signal is received at the nurse's station.

If either or both fail to work, check all connections and retest.

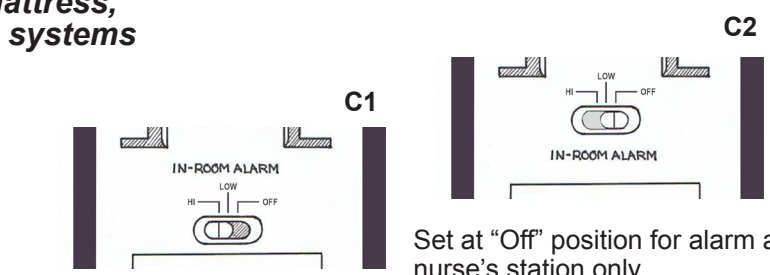

Set at "Hi" or "Low" position for alarm at bedside and nurse's station.

Reorder #	Description	Unit
909560	Nurse call accessory Connector Kit	Set
909247	Y-connector for Multipro Bedpro alarm	Each
909242	Nurse call cable only	Each

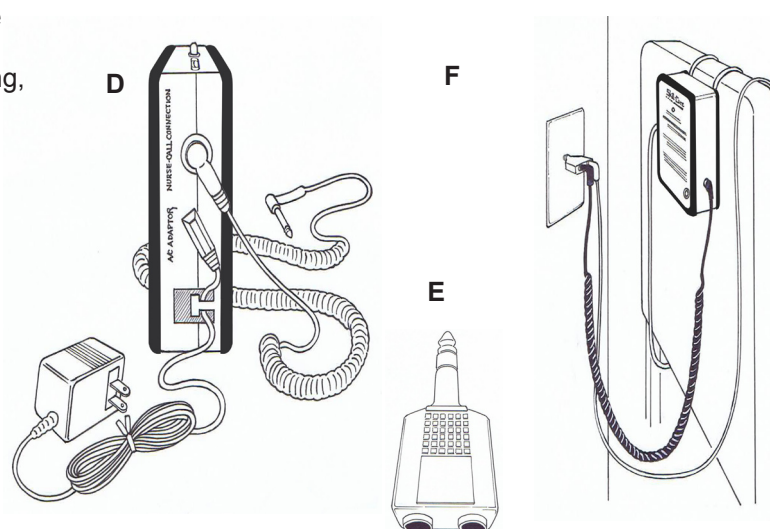

SENSOR PAD SETUP

BedPro™ UnderMattress Safety Alarm

Reorder#	Description	Unit
909320	BedPro UnderMattress Safety Alarm with 10"x30" Sensor Pad - 90 Days	Set
909321	BedPro UnderMattress Safety Alarm with 20"x30" Sensor Pad - 90 Days	Set
909322	BedPro UnderMattress Safety Alarm with 10"x30" Sensor Pad - 180 Days	Set
909323	BedPro UnderMattress Safety Alarm with 20"x30" Sensor Pad - 180 Days	Set
909340	BedPro UnderMattress Safety Alarm with 10"x30" Sensor Pad - 1 Year	Set
909341	BedPro UnderMattress Safety Alarm with 20"x30" Sensor Pad - 1 Year	Set
909343	BedPro UnderMattress Safety Alarm for Light Mattresses 39-42lbs. - 2 Year	Set

This BedPro Safety Alarm from Skil-Care features an under mattress sensor pad that is protected against incontinence and wear by the mattress. Unlike sensor pads that are placed on the mattress, the BedPro UnderMattress sensor will not compromise the pressure relieving qualities of the mattress. Placed beneath the mattress, the BedPro sensor pad stays in place to reduce false alarms. This is especially important for restless resident's.



- Continued on page 4 -

SENSOR PAD SET UP

Sensor Pad Setup for BedPro UnderMattress System (contd.)

- Remove mattress and place sensor pad across width of bed frame (Illustration G1 and G2), for 2 year sensor, see Illustration G3. Where access permits attach 2 year sensor with hook and loop strap provided
- Position connector cable toward headboard. The opposite end must be positioned just below the resident's pelvis.
- Pass sensor cable under headboard and tuck it under the Cable Strain-Relief tab before inserting it into the Modular Connection (Illustration H). The strain-relief tab prevents the plug from being accidentally dislodged and damaged. Be certain to keep cable away from side rails and out of resident's reach.
- Place mattress on bed.
- Sensor maybe cleaned with a damp cloth and mild cleanser. Do not immerse pad in water or cleaning solution. Do not sterilize.
- Inspect pad before each use. Replace if damaged.

Read "Warnings" on sensor pad

Important: This UnderMattress sensor is designed to work with most mattresses and beds. However, due to differences in mattress construction, bed designs, and resident weight, this sensor pad may not work in all situations. Be certain to evaluate the alarm system's operation for each bed and resident. If it does not work, you may want to consider Skil-Care's BedPro OverMattress sensor pad.

Proceed to "System Operation" on page 6. See page 6 for information about ordering replacement sensor pads.

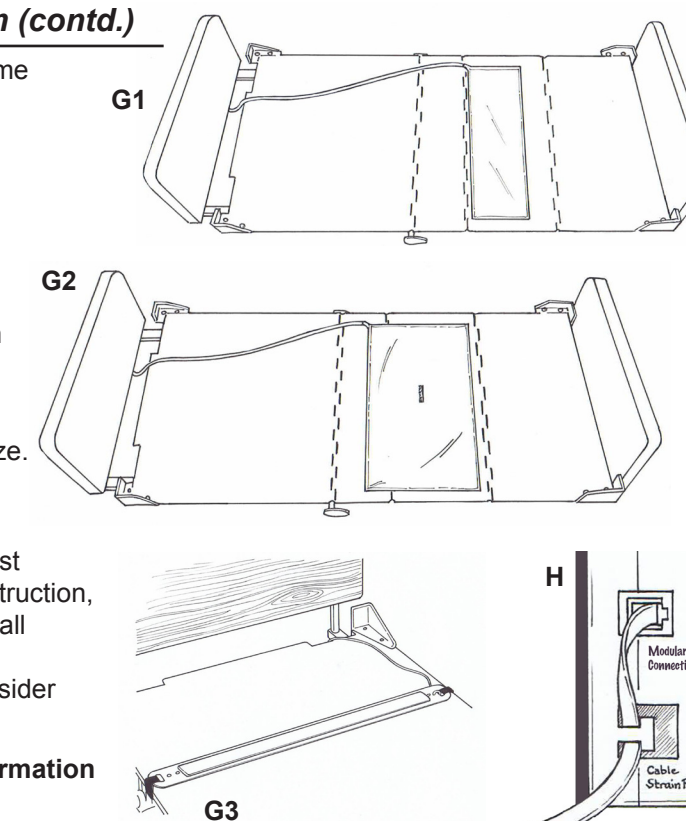

SENSOR PAD SET UP

BedPro™ Early Warning Under Mattress Safety Alarm

Reorder#	Description	Unit
909301	BedPro Early Warning System with 30-inch-long sensor pad - 90 Days	Set
909302	BedPro Early Warning System with 30-inch-long sensor pad - 180 Days	Set

This alarm system features a unique under-mattress sensor pad that is designed to activate an alarm signal before the resident exits the bed. The diagonally tapered sensor pad initiates the alarm when the resident sits on or moves toward the edge of the bed. Placed beneath the mattress, the sensor will not compromise the pressure relieving qualities of the mattress. The mattress protects the sensor pad against incontinence, resident tampering, and incontinence.

Sensor Pad Setup for BedPro Early Warning UnderMattress System

- Remove mattress. For resident who exits bed on left side, place diagonal edge facing left side of the bed platform as shown (Illustration G4). For resident who exits bed on the right side, place diagonal edge facing right side of the bed platform as shown (Illustration G5). A resident usually exits the bed from the opposite side, the alarm will activate when the resident stands. It will not, in this case, provide an early warning.
- Position the sensor cable towards headboard. Make certain that the wide section of the sensor pad is positioned just below the resident's shoulders.

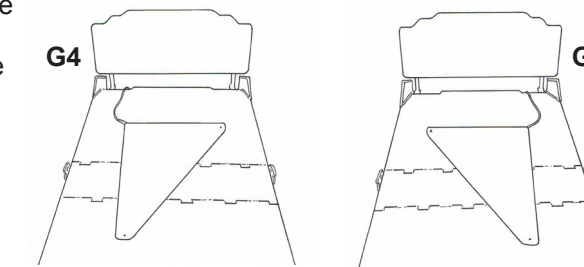

- Continued on page 5 -