



Proud Sponsor

Quick start guide

**TR1909**

**Trimline® telephone  
with caller ID/call waiting**

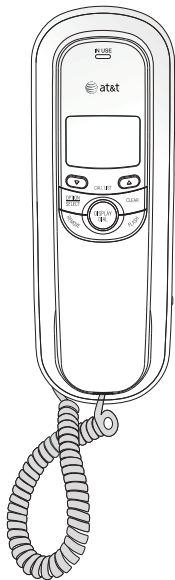

Make sure to install four AA alkaline batteries (not included) before using the telephone.



See page 4 for easy instructions.

## Introduction

This quick start guide provides you basic installation and use instructions. A limited set of features are described in abbreviated form.



Please refer to the complete on-line **TR1909 Trimline® telephone with caller ID/call waiting** user's manual for a full set of installation and operation instructions at

**<http://www.telephones.att.com/manuals/TR1909>**.

Before using this AT&T product, please read **Important safety information** on page 16 of this quick start guide.

## Table of contents

Parts checklist .....	1	Options while on calls.....	11
Handset layout .....	2	Storing numbers in memory...	12
Battery installation.....	4	Troubleshooting .....	14
Telephone installation .....	5	Important safety information .....	16
Wall installation .....	6	FCC and ACTA information.....	17
Switching from wall installation to desktop.....	8	FCC Part 15.....	18
About the feature menu.....	9	Limited warranty.....	19
Feature summary.....	9	Technical specifications .....	21
Basic telephone operation .....	10		

# Parts checklist

Save your sales receipt and original packaging in the event warranty service is necessary.

Your telephone contains the following items:



Quick start guide



Handset

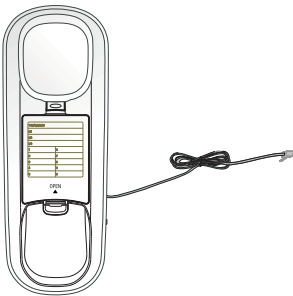

Telephone base with telephone line cord and mounting bracket

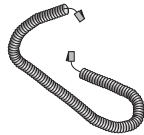

Coiled handset cord

# Handset layout

## IN USE light

Flashes quickly when there is an incoming call.

Flashes slowly when the telephone line cord is not plugged into a wall jack or another telephone on the same line is in use.

On when the telephone line is in use.

## OPTION/SELECT

Press to display the setting options.

While in the option menu, press to save the selection and move to the next feature.

While reviewing the call log, press repeatedly to show different dialing formats.

## REMOVE

While reviewing the call log, press to delete the entry currently displayed, or **press and hold** to remove all entries.

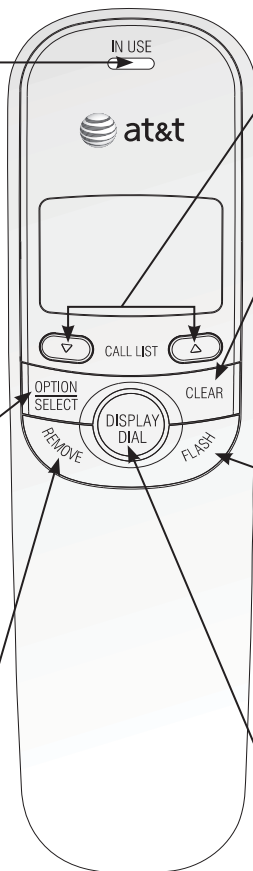

## CALL LIST ▼/▲

When the telephone is idle, press to display caller ID information.

## CLEAR

Press to exit storing a number in memory, to exit the call log, or to return to the idle screen anytime without saving the changes.

## FLASH

When there is a call waiting signal, press **FLASH** to put the current call on hold and connect to the new call. Press **FLASH** again to return to the original call.

Press **FLASH** to activate other telephone company subscriber services such as three-way calling.

## DISPLAY DIAL

Press to dial the number currently displayed.



# Handset layout

## M1, M2, M3

When the handset is lifted, press to dial a number from the one-touch memory.

## Listening volume

Slide to adjust the handset listening volume to **LO**, **MED** or **HI**.

## MEMORY

Press to access telephone numbers stored in the speed dial memory.

## MUTE

Press and hold **MUTE** to silence the microphone to prevent the other party from hearing you; you are still able to hear the other party. Release **MUTE** to return to the conversation.

## Switch hook

When held down, the telephone is in idle mode.

When released, the telephone is ready to make a call.

## Dialing keys

Press to dial a number.

## PAUSE/REDIAL

When the handset is lifted, press to redial the last number dialed.

When storing a number in the memory, press to insert a three-second dialing pause.

## PROG

Press to store a telephone number in the memory.



# Battery installation

Before using the telephone, install four good AA alkaline batteries (not included) to provide memory backup, and to enable features such as caller ID and the **IN USE** light. If good batteries are not installed, the display only works when you lift the handset. When operating in this mode, the display may be dimmer than usual. It is recommended that you install new batteries soon after the low battery icon appears.

Follow the steps below to install batteries:

1. Press on the tab and lift to open the cover of the battery compartment.



Press this tab to release.

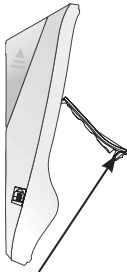

Lift this tab to open.

2. Install four new AA batteries (not included) in the battery compartment according to the engraved labels, + and -, in the compartment. Place the batteries above the battery strap.

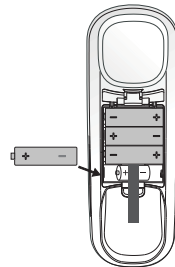

3. Close the battery compartment cover. Make sure it clicks into place.

## NOTES:

- Do not mix old and new batteries, and do not mix alkaline and standard (carbon-zinc) batteries.
- Always disconnect the telephone line from the telephone wall jack before replacing batteries.
- Install new batteries every six months to maintain the call log and telephone memory.

# Telephone installation

If you subscribe to high-speed Internet service (DSL - digital subscriber line) through your telephone lines, you must install a DSL filter between the telephone line cord and the telephone wall jack. The filter prevents noise and caller ID problems caused by DSL interference. Please contact your DSL service provider for more information about DSL filters.

Install the telephone as shown below:

1. Plug one end of the coiled handset cord into the handset jack on the left side of the telephone base. Plug the other end into the handset.
2. One end of the telephone line cord has been installed into the telephone jack at the bottom of the telephone base. Route the telephone line cord through the slot as shown.
3. Plug the other end of the cord into a telephone wall jack.
4. Put the handset on the telephone base.

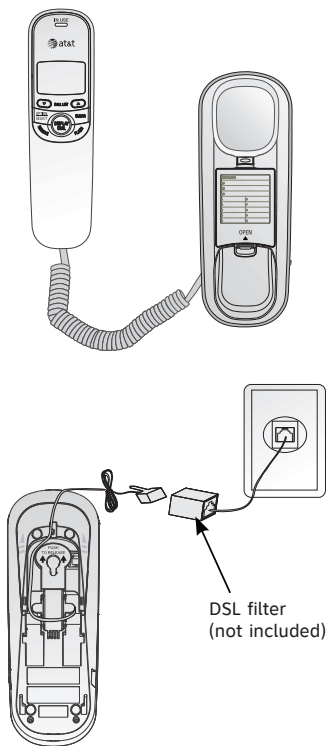

## Wall installation

Your telephone base is ready for desktop use. If you want to mount your telephone on a wall, use the provided mounting bracket to connect with a standard dual-stud telephone wall mounting plate. If you do not have this mounting bracket, you can purchase one from many hardware or consumer electronic retailers. You may need professional assistance to install the mounting plate.

To install the telephone base in the wall mount position, make sure that you first unplug the telephone line cord from the telephone wall jack and remove it from the slot under the telephone base.

1. Lift the handset and place it aside. On the telephone base, pull out the handset tab and rotate it 180 degrees. Replace the handset tab into the grooves until it clicks into position.

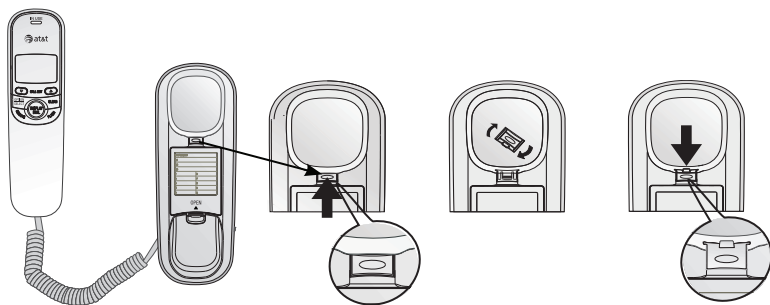

2. Remove the mounting bracket from the base. Hold the telephone base with both hands and then slide the bracket upwards as the arrows indicate.

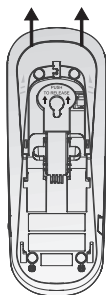

## Wall installation

3. Rotate the bracket 180 degrees to the wall mounting position. Push the bracket upwards as shown until it clicks into place.

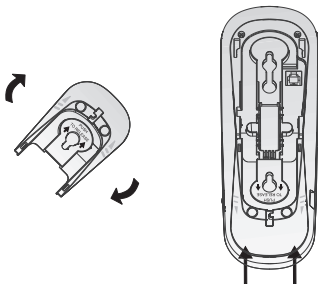

4. Route the telephone line cord through the slot as shown and plug the other end of the cord into a telephone wall jack. To mount the telephone on the wall, position the mounting holes A and B over the telephone outlet mounting studs. Slide the bracket down firmly so the telephone is held securely on the studs.

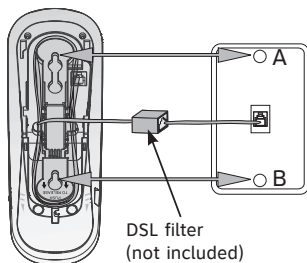

5. Place the handset back on the telephone base.

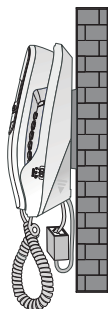

## Switching from wall installation to desktop

To return the bracket from wall mount position to desktop use, follow the instructions below:

1. Remove the telephone base from the mounting plate. Unplug the telephone line cord from the telephone wall jack and remove the cord from the slots under the telephone base.
2. Lift the handset and place it aside. On the telephone base, pull out the handset tab and rotate it 180 degrees. Replace the handset tab back to the grooves until it clicks into position.

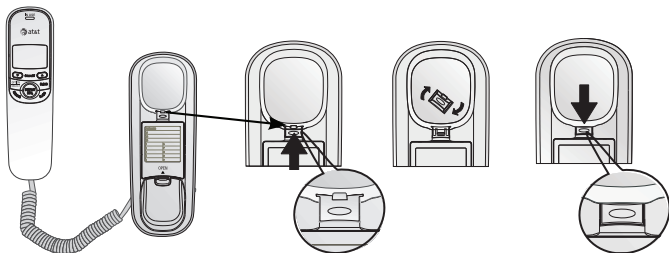

3. Remove the bracket from the base. Hold the telephone base firmly and then slide the bracket downwards as the arrows indicate.

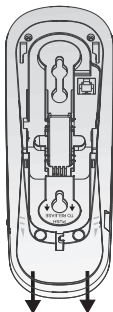

4. Rotate the bracket to the desktop installation position. Push the bracket down as shown below until it clicks into place.

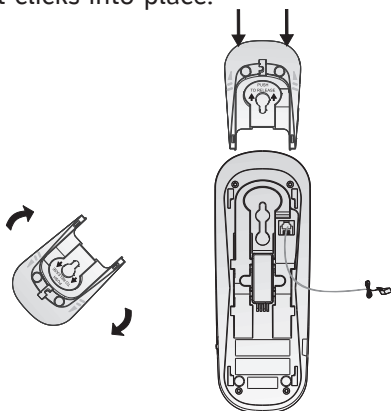

5. Follow steps 2-4 in **Telephone installation** on page 5 to install your telephone for desktop use.

# About the feature menu

The table below provides a summary of the feature menu. Use the instructions below to change the setting in the menu:

1. When the telephone is idle, press **OPTION/SELECT** repeatedly until the screen displays the desired feature.
2. Press ▼ or ▲ until the screen displays the desired setting.
3. Press **OPTION/SELECT** within 10 seconds to save your selection and move to the next feature.

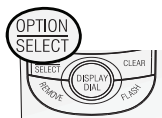

- **OR** -

Press **CLEAR** to exit without saving your selection and return to idle mode.

- **OR** -

Wait 10 seconds to exit without saving your selection and return to idle mode automatically.

## Feature summary

Default settings are indicated by an asterisk (\*).

Screen display	Function	Options
<b>SET CONTRAST</b>	Adjust the screen brightness to a comfortable level, from 1 (lightest) to 5 (darkest). The contrast may be different for desktop and wall mount installation.	<b>1, 2, 3*, 4, 5</b>
<b>HOME AREA CODE?</b>	Set the telephone to recognize calls from the home area code.	<b>HAC - ___</b>
<b>LOCAL AREA CODE?</b>	Program up to four area codes which may not require dialing 1 before them.	<b>LAC 1- ___ LAC 2- ___ LAC 3- ___ LAC 4- ___</b>
<b>SET TIME/DATE</b>	Set the time and date on the handset.	<b>12:00<sup>AM</sup>, 1/01</b>
<b>SET LANGUAGE</b>	Choose the screen display language.	<b>ENGLISH* FRANCAIS ESPANOL</b>
<b>SET TONE/PULSE</b>	Set whether the telephone should be tone dial or pulse dial.	<b>TONE* PULSE</b>

**i NOTE:** The features are listed in the order they appear after the initial setup. When you first install batteries, the order is: **SET LANGUAGE, SET CONTRAST, HOME AREA CODE?, LOCAL AREA CODE?, SET TIME/DATE** and **SET TONE/PULSE**.

# Basic telephone operation

## Make and answer a call

---

To make a call:

1. Lift the handset and wait for a dial tone.
2. Use the dialing keys to enter the number you want to dial.
3. Place the handset on the telephone base to hang up.

To answer a call:

1. Lift the handset.
2. Place the handset on the telephone base to hang up.

## Last number redial

---

To redial the last number you dialed out (up to 32 digits), follow the steps below:

1. Lift the handset and wait for a dial tone.
2. Press **REDIAL/PAUSE** on the handset.
3. Place the handset on the telephone base to hang up.



## Adjust ringer volume

---

To adjust the ringer volume, slide the **RINGER** switch on the right side of the telephone base. You can set the ringer to off, low or high (**OFF**, **LO** or **HI**).

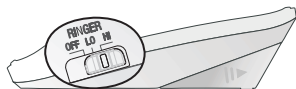

## Adjust listening volume

---

To adjust the listening volume, lift the handset and slide the volume switch on the handset. You can set the listening volume to low, medium or high (**LO**, **MED** or **HI**).

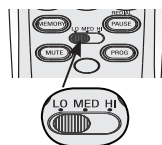



# Options while on calls

## Flash

---

If you subscribe to call waiting service from your local telephone service provider, you hear a beep if someone calls while you are already on a call. Press **FLASH** on the handset to put your current call on hold and take the new call. You can press **FLASH** anytime to switch back and forth between calls and to activate other telephone company subscriber services such as three-way calling. Contact your telephone service provider for information on subscriber services.

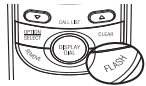

## Mute

---

You can press and hold **MUTE** to silence the microphone during a conversation. You can hear the caller, but the caller does not hear you until you release **MUTE** to resume conversation.

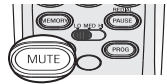

## Temporary tone dialing

---

This feature can temporarily switch from pulse to touch-tone dialing during a call.

1. During a call, press **TONE ✕**.
2. Use the dialing keys to enter the relevant number. The telephone sends touch-tone signals.
3. The telephone automatically returns to pulse dialing mode after you hang up.

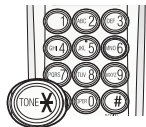

# Storing numbers in memory

This telephone has 13 memory locations with three one-touch memory location buttons (**M1**, **M2**, **M3**) and 10 speed dial memory locations (**0** through **9**). Each location can hold a number up to 32 digits.

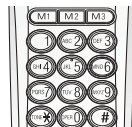

## To store a number in a one-touch memory location

Follow the steps below to store a number in a one-touch memory location:

1. Lift the handset and press **PROG**.
2. Use the dialing keys to enter the number you want to store. Press **PAUSE/REDIAL** once to store a three-second pause in the dialing sequence, twice for a six-second pause and so on.



**- OR -**

Press **PAUSE/REDIAL** to store the last number dialed.

3. Press the one-touch memory location button (**M1**, **M2** or **M3**) where you want the number to be stored. The screen briefly displays **EX**, where **X** is the memory location.

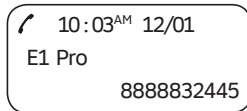
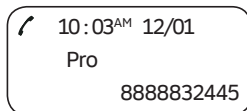

### **i** **NOTES:**

- When you store a new number in a one-touch memory location, the old entry is replaced and cannot be retrieved.
- If no action is taken within 10 seconds, the telephone returns to idle mode automatically without saving your selection.

# Storing numbers in memory

## To store a number in a speed dial memory location

You can store up to 10 numbers in the speed dial memory locations (**0** through **9**). Each location can hold a number up to 32 digits.

To store a number in a speed dial memory location:

1. Lift the handset and press **PROG.**
2. Use the dialing keys to enter the number you want to store. Press **PAUSE/REDIAL** once to add a three-second dialing sequence, twice for a six-second pause and so on.

- OR -

Press **PAUSE/REDIAL** to store the last number dialed.

3. Press **MEMORY**, then press the dialing key (**0** through **9**) where you want the number to be stored. The screen briefly displays **AX**, where **X** is the memory location.

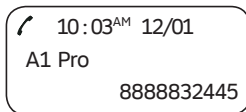
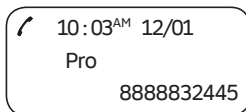

### NOTES:

- When you store a new number in a speed dial memory location, the old entry is replaced and cannot be retrieved.
- If no action is taken within 10 seconds, the telephone returns to idle mode without saving your selection.

# Troubleshooting

If you have difficulty with your telephone, please try the suggestions below. For customer service, visit our website at **www.telephones.att.com** or call **1 (800) 222-3111**.

In Canada, dial **1 (866) 288-4268**.

## **There is no dial tone.**

- Inspect the telephone line cord connection at the telephone wall jack. Make sure the cord is connected properly and securely.
- Inspect the handset cord connections at both ends.
- If the previous suggestions do not work, disconnect the telephone base from the telephone jack and connect to a different telephone. If there is no dial tone on that telephone either, the problem is in your wiring or local service. Contact your telephone service provider.

## **Telephone does not ring.**

- Make sure the **RINGER** switch on the side of the telephone base is not set to **OFF**.
- If there are other telephones on the same line, try disconnecting some of them. Having too many telephones connected can create problems such as low ringer volume or impaired sound quality during calls.

## **Difficulty storing numbers in memory.**

- Make sure you are pressing the correct sequence of buttons for storing numbers (see pages 12 and 13).
- If you pause for over 10 seconds when programming an entry, the procedure will time out and you will have to begin again.
- Try calling the number to be stored in memory. When the call ends, press **PROG**, **PAUSE/REDIAL**, then a one-touch button (**M1**, **M2** or **M3**), or **MEMORY** and a memory location (**0-9**).

# Troubleshooting

## **IN USE light does not go on.**

- Make sure four new AA batteries have been installed properly (see **Battery installation** on page 4).

## **The IN USE light is flashing slowly.**

- Make sure that all telephones on the same line are hung up.
- Inspect the telephone line cord connection at the wall jack.

## **Screen is blank.**

- Make sure the coiled handset cord is properly and securely connected to the handset and the telephone base.
- Make sure four new AA batteries are installed properly (see **Battery installation** on page 4).
- You must subscribe to caller ID service from your telephone service provider to see call information on the screen.

## **My caller ID features are not working properly.**

- Caller ID is a subscription service. You must subscribe to this service from your telephone service provider for this feature to work on your telephone.
- The caller may not be calling from an area that supports caller ID. Both your and the caller's telephone service providers must use equipment which are compatible with caller ID service.
- Make sure your service provides caller ID information when on a call. This is sometimes known as caller ID with call waiting, or type II caller ID.
- Make sure you have installed four new AA batteries properly (see **Battery installation** on page 4).
- If you subscribe to high-speed Internet service (DSL - digital subscriber line) through your telephone line, you must install a DSL filter between the telephone line cord and the telephone wall jack. The filter prevents noise and caller ID problems caused by DSL interference. Please contact your DSL service provider for more information about DSL filters.

# Troubleshooting

## **I subscribe to a nontraditional telephone service that uses my computer to establish connections, and my telephone doesn't work.**

- Make sure your computer is powered on.
- Make sure your Internet connection is working properly.
- Make sure that the software is installed and running for your nontraditional telephone service.
- Make sure to plug your USB telephone adapter into a dedicated USB port on your computer. Do not plug it into a multiple port USB hub (USB splitter) that is not powered.
- In a few rare cases, the USB port on your computer may not have enough power. In these instances, try using a USB hub with its own external power supply.
- If you are using a firewall, it may prevent access to your nontraditional telephone service. Contact your service provider for more information.

## Important safety information



This symbol is to alert you to important operating or servicing instructions that may appear in this quick start guide. Always follow basic safety precautions when using this product to reduce the risk of injury, fire, or electric shock.

### Safety information

---

- **Read and understand all instructions in this quick start guide. Observe all markings on the product.**
- **Avoid using a telephone during a thunderstorm.** There may be a slight chance of electric shock from lightning.
- **Do not use a telephone in the vicinity of a gas leak.** If you suspect a gas leak, report it immediately, but use a telephone away from the area where gas is leaking. If this product is a cordless model, make sure the base is also away from the area.
- **Do not use this product near water, or when you are wet.** For example, do not use it in a wet basement or shower, or next to a swimming pool, bathtub, kitchen sink, or laundry tub. Do not use liquids or aerosol sprays for cleaning. If the product comes in contact with any liquids, unplug any line or power cord immediately. Do not plug the product back in until it has dried thoroughly.
- **If this product has replaceable batteries, replace batteries only as described in this quick start guide (see Battery installation on page 4).** Do not burn or puncture batteries - they contain caustic chemicals.

# FCC and ACTA information

If this equipment was approved for connection to the telephone network prior to July 23, 2001, it complies with Part 68 of the Federal Communications Commission (FCC) rules. If the equipment was approved after that date, it complies with the Part 68 rules and with the Technical Requirements for Connection of Equipment to the Telephone Network adopted by the Administrative Council for Terminal Attachments (ACTA). We are required to provide you with the following information.

## 1. Product identifier and REN information

The label on the back or bottom of this equipment contains, among other things, an identifier indicating product approval and the Ringer Equivalence Number (REN). This information must be provided to your telephone service provider upon request. For equipment approved prior to July 23, 2001, the product identifier is preceded by the phrase "FCC Reg No." and the REN is listed separately. For equipment approved after that date, the product identifier is preceded by "US" and a colon (:), and the REN is encoded in the product identifier without a decimal point as the sixth and seventh characters following the colon. For example, the product identifier US:AAAEQ03T123XYZ indicates the REN would be 0.3.

The REN is used to determine how many devices you can connect to your telephone line and still have them ring when you are called. In most, but not all areas, the sum of all RENS should be five (5.0) or less. You might want to contact your telephone service provider for more information.

## 2. Connection and use with the nationwide telephone network

The plug and jack used to connect this equipment to the premises wiring and the telephone network must comply with the applicable part 68 rules and technical requirements adopted by ACTA. A compliant telephone cord and modular plug is provided with this product. It is designed to be connected to a compatible modular wall jack that is also compliant. An RJ11 jack should normally be used for connecting to a single line and an RJ14 jack for two lines, see installation instructions in the user's manual. This equipment may not be used with coin telephone lines or with party lines. If you have specially wired alarm dialing equipment connected to your telephone line, ensure the connection of this equipment does not disable your alarm equipment. If you have questions about what will disable the alarm equipment, consult your telephone service provider or qualified installer.

## 3. Repair instructions

If this equipment is malfunctioning, it must be unplugged from the modular wall jack until the problem has been corrected. Repairs to this telephone equipment can only be made by the manufacturer or its authorized agents. For repair procedures, follow the instructions outlined under the limited warranty.

## 4. Rights of the telephone service provider

If this equipment is causing harm to the telephone network, the telephone service provider may temporarily discontinue your telephone service. The telephone service

# FCC and ACTA information

provider is required to notify you before interrupting service. If advance notice is not practical, you will be notified as soon as possible. You will be given the opportunity to correct the problem and the telephone service provider is required to inform you of your right to file a complaint with the FCC. Your telephone service provider may make changes in its facilities, equipment, operation, or procedures that could affect the proper functioning of this product. The telephone service provider is required to notify you if such changes are planned.

## 5. Hearing aid compatibility

If this product is equipped with a corded or cordless handset, it is hearing aid compatible.

## 6. Programming/testing of emergency numbers

If this product has memory dialing locations, you may choose to store police, fire department and emergency medical service telephone numbers in these locations. If you do, please keep three things in mind:

- a. We recommend that you also write the telephone number on the directory card (if applicable), so that you can still dial the emergency number manually if the memory dialing feature doesn't work.
- b. This feature is provided only as a convenience, and the manufacturer assumes no responsibility for customer reliance upon the memory feature.
- c. Testing the emergency telephone numbers you have stored is not recommended. However, if you do make a call to an emergency number:
  - You must remain on the line and briefly explain the reason for the call before hanging up.
  - Programming/testing of emergency numbers should be performed during off-peak hours, such as in the early morning or late evening, when the emergency services tend to be less busy.

## FCC Part 15

If this product causes interference to radio, VCR or television reception when it is in use, you might correct the interference with any one or all of these measures:

- Where it can be done safely, reorient the receiving radio, VCR or television antenna.
- To the extent possible, relocate the radio, VCR, television or other receiver with respect to the telephone equipment.
- If this telephone product runs on AC power, plug your product into an AC outlet that's not on the same circuit as one used by your radio, VCR or television.
- Consult a dealer or an experienced radio/TV technician for help.

**Modifications to this product, not expressly approved by the manufacturer, could void the user's authority to operate the equipment.**



# Limited warranty

The AT&T brand is used under license - any repair, replacement or warranty service, and all questions about this product should be directed to: In the United States of America, call **1 (800) 222-3111** or visit **www.telephones.att.com**. In Canada, dial **1 (866) 288-4268**.

## 1. What does this limited warranty cover?

The manufacturer of this AT&T-branded product warrants to the holder of a valid proof of purchase (“CONSUMER” or “you”) that the product and all accessories provided in the sales package (“PRODUCT”) are free from defects in material and workmanship, pursuant to the following terms and conditions, when installed and used normally and in accordance with the PRODUCT operating instructions. This limited warranty extends only to the CONSUMER for products purchased and used in the United States of America and Canada.

## 2. What will be done if the PRODUCT is not free from defects in materials and workmanship during the limited warranty period (“materially defective PRODUCT”)?

During the limited warranty period, the manufacturer’s authorized service representative repairs or replaces at the manufacturer’s option, without charge, a materially defective PRODUCT. If the manufacturer repairs the PRODUCT, they may use new or refurbished replacement parts. If the manufacturer chooses to replace the PRODUCT, they may replace it with a new or refurbished PRODUCT of the same or similar design. The manufacturer retains the defective parts, modules, or equipment. Repair or replacement of the PRODUCT, at the manufacturer’s option, is your exclusive remedy. The manufacturer returns the repaired or replacement products to you in working condition. You should expect the repair or replacement to take approximately 30 days.

## 3. How long is the limited warranty period?

The limited warranty period for the PRODUCT extends for ONE (1) YEAR from the date of purchase. If the manufacturer repairs or replaces a materially defective PRODUCT under the terms of this limited warranty, this limited warranty also applies to repaired or replacement PRODUCT for a period of either (a) 90 days from the date the repaired or replacement PRODUCT is shipped to you or (b) the time remaining on the original one-year limited warranty; whichever is longer.

# Limited warranty

## 4. What is not covered by this limited warranty?

This limited warranty does not cover:

- PRODUCT that has been subjected to misuse, accident, shipping or other physical damage, improper installation, abnormal operation or handling, neglect, inundation, fire, water, or other liquid intrusion; or
- PRODUCT that has been damaged due to repair, alteration, or modification by anyone other than an authorized service representative of the manufacturer; or
- PRODUCT to the extent that the problem experienced is caused by signal conditions, network reliability or cable or antenna systems; or
- PRODUCT to the extent that the problem is caused by use with non-AT&T accessories; or
- PRODUCT whose warranty/quality stickers, PRODUCT serial number plates or electronic serial numbers have been removed, altered or rendered illegible; or
- PRODUCT purchased, used, serviced, or shipped for repair from outside the United States of America or Canada, or used for commercial or institutional purposes (including but not limited to products used for rental purposes); or
- PRODUCT returned without a valid proof of purchase (see item 6 below); or
- Charges for installation or setup, adjustment of customer controls, and installation or repair of systems outside the unit.

## 5. How do you get warranty service?

To obtain warranty service in the United States of America, visit

**[www.telephones.att.com](http://www.telephones.att.com)** or call **1 (800) 222-3111**.

In Canada, dial **1 (866) 288-4268**. NOTE: Before calling for service, please review the user's manual. A check of the PRODUCT controls and features might save you a service call.

Except as provided by applicable law, you assume the risk of loss or damage during transit and transportation and are responsible for delivery or handling charges incurred in the transport of the PRODUCT(s) to the service location.

The manufacturer will return repaired or replaced PRODUCT under this limited warranty. Transportation, delivery or handling charges are prepaid. The manufacturer assumes no risk for damage or loss of the PRODUCT in transit. If the PRODUCT failure is not covered by this limited warranty, or proof of purchase does not meet the terms of this limited warranty, the manufacturer notifies you and requests that you authorize the cost of repair prior to any further repair activity. You must pay for the cost of repair and return shipping costs for the repair of products that are not covered by this limited warranty.

# Limited warranty

## 6. What must you return with the PRODUCT to get warranty service?

You must:

- Return the entire original package and contents including the PRODUCT to the service location along with a description of the malfunction or difficulty; and
- Include a “valid proof of purchase” (sales receipt) identifying the PRODUCT purchased (PRODUCT model) and the date of purchase or receipt; and
- Provide your name, complete and correct mailing address, and telephone number.

## 7. Other limitations

This warranty is the complete and exclusive agreement between you and the manufacturer of this AT&T branded PRODUCT. It supersedes all other written or oral communications related to this PRODUCT. The manufacturer provides no other warranties for this PRODUCT. The warranty exclusively describes all of the manufacturer’s responsibilities regarding the PRODUCT. There are no other express warranties. No one is authorized to make modifications to this limited warranty and you should not rely on any such modification.

State/Provincial Law Rights: This warranty gives you specific legal rights, and you might also have other rights that vary from state to state or province to province.

Limitations: Implied warranties, including those of fitness for a particular purpose and merchantability (an unwritten warranty that the PRODUCT is fit for ordinary use) are limited to one year from date of purchase. Some states/provinces do not allow limitations on how long an implied warranty lasts, so the above limitation might not apply to you. In no event shall the manufacturer be liable for any indirect, special, incidental, consequential, or similar damages (including, but not limited to lost profits or revenue, inability to use the PRODUCT or other associated equipment, the cost of substitute equipment, and claims by third parties) resulting from the use of this PRODUCT. Some states/provinces do not allow the exclusion or limitation of incidental or consequential damages, so the above limitation or exclusion might not apply to you.

**Please retain your original sales receipt as proof of purchase.**

## Technical specifications

Operation temperature	32°F - 122°F 0°C - 50°C
REN (Ringer Equivalence Number)	0.7B



Proud Sponsor

**[www.telephones.att.com](http://www.telephones.att.com)**

Trimline® is a registered trademark of Advanced American Telephones.

© 2009-2010 Advanced American Telephones. All Rights Reserved.  
AT&T and the AT&T logo are trademarks of AT&T Intellectual Property licensed to  
Advanced American Telephones, San Antonio, TX 78219.  
Printed in China. Issue 10 AT&T 05/10