

Sterilization of DeVilbiss Professional Atomizers, Powder Blowers, Syringes and Nebulizers

These sterilization instructions are applicable for the following products: Atomizer Models 15-RD, 151, 163; Powder Blower Models 119 and 175; Nebulizers Models 45, 180, 646; Irrigation Syringe model 177.

All metal and glass components (except glass tubes) of these instruments can be autoclaved by following the sterilizing device manufacturer's recommendation at a temperature of 273°F for a maximum of 15 minutes. The plastic outlet tubing and Plastisol bulbs should not be autoclaved as they will change shape after 2 or 3 cycles.

Instead, you may use 1/3 bleach to 2/3 water for not more than 10-15 minutes; Cidex (2.4% glutaraldehyde solution) may also be used. Be sure to follow the manufacturers' directions for mixing and using these products.

After cleaning be sure to rinse with warm or hot water and completely air dry before adding medication.

The cleaning of the tubing or air cut-off assembly leading from the compressor or air line may be accomplished with the above stated solutions as well.

This warranty gives you specific legal rights, and you may also have other rights which vary from state to state.

YOU ABOVE LIMITATION OR EXCLUSION MAY NOT APPLY TO OF CONSEQUENTIAL OR INCIDENTAL DAMAGES, SO THE WARRANTY LASTS, OR THE LIMITATION OR EXCLUSION NOT ALLOW LIMITATIONS ON HOW LONG AN IMPLIED EXCLUSION IS PERMITTED BY LAW. SOME STATES DO CONSEQUENT AND INCIDENTAL DAMAGES UNDER ANY THIS IS THE EXCLUSIVE REMEDY AND LIABILITY FOR ANY AND ALL IMPLIED WARRANTIES ARE EXCLUDED. WARRANTY AND TO THE EXTENT PERMITTED BY LAW LIMITED TO THE DURATION OF THE EXPRESS LIMITED AND FITNESS FOR A PARTICULAR PURPOSE, ARE WARRANTIES, INCLUDING THOSE OF MERCHANTABILITY THERE IS NO OTHER EXPRESS WARRANTY. IMPLIED

in repairing or replacing defective part(s). in rental while said unit is under repair, or costs for labor incurred providing a loaner instrument, compensating for costs incurred and reason for return. **NOTE**—This warranty does not cover, (2) a letter with your name, address, daytime phone number, Return Authorization number on the outside of the package and will advise you if a charge is involved. If returning, include (1) issue a Return Authorization number. The Service Department call 800-338-1988 (814-443-4881) for the Service Department to the instructions. If repair or replacement is necessary, please the malfunction is not due to inadequate cleaning or failure to follow DeVilbiss' option if the instrument has not been tampered with or used improperly during that period. Make certain that any purchase. Any defective part(s) will be repaired or replaced at this instrument is warranted to be free from defective work-

SIX-MONTH LIMITED WARRANTY

Warranty 3

MODEL 15-RD

DeVilbiss Atomizers are quality instruments that provide the benefits of spray application shown in the following illustrations. If they are kept clean and used as instructed, they will be completely satisfactory in both operation and service.



Illustrations are based on x-ray research.

TO USE—Fill bottle to shoulder. Grasp bulb firmly, using fingers against palm of hand. When spraying throat, REMOVE nasal guard. Swing spray tip up or down to direct spray as desired. When spraying nose, unless the physician has otherwise directed, slip nasal guard over spray tip, allowing end of tip to protrude through opening.

TO CLEAN—Use a fine wire and follow directions given with illustrations below.

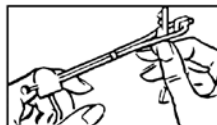

Place a ballpoint pen/key between spray tubes and turn, spreading tubes apart, leaving ballpoint pen/key in place. Remove atomizer tip.

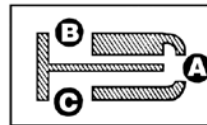

Insert a fine wire into point of tip A, cleaning the two passages shown. Be sure to insert wire until visible in openings B & C.

TO STERILIZE—Autoclave (remove the plastic outlet tube, plastisol bulb, and black washer). Use 1/2 bleach to 2/3 water for not more than 10-15 minutes. Cidex (2.4% glutaraldehyde solution) may also be used. Be sure to follow the manufacturer's directions for mixing and using these products. After cleaning, be sure to rinse atomizer with warm or hot water and air dry before adding medication. Or, the all-metal spraying parts of this atomizer make it especially suitable for heat sterilization.

To replace atomizer tip, attach it to one of the tubes - make sure the grooved side is on the bottom - turn and remove key. Atomizer tubes snap into position.

WARNING

After replacing atomizer tip, ensure that it is firmly in place between spray tubes. Failure to do so may result in the tip being blown into the body with possible injury.

MODEL 151

This vacuum-type atomizer is especially designed for use with aqueous solutions in nose and throat treatment, irrigation and cleaning of wounds, and for those solutions that tend to crystallize. The metal inner tube around which crystals usually form is easily removed and cleaned. This atomizer supplies a fine mist without force, and is equipped with a small diameter tube that can be inserted well up into the nasal passages. The spray tube is removable for sterilization.

TO USE—To secure best results, fill bottle not more than two-thirds full. The atomizer may be operated with either compressed air or hand bulb. If hand bulb is used, grasp the bulb firmly using the fingers against the palm of the hand rather than two or three fingers against the thumb.

TO CLEAN—Unscrew the inner tube and wipe clean. The illustrations below show details of the cleaning operation.



Disassemble the atomizer by rotating the cap in a counterclockwise direction. The spray tube assembly can be removed from the cap by rotating in a counterclockwise direction.

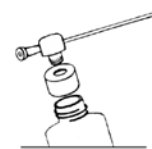

TO STERILIZE—Autoclave (remove the plastisol bulb and black washer). Use 1/2 bleach to 2/3 water for not more than 10-15 minutes. Cidex (2.4% glutaraldehyde solution) may also be used. Be sure to follow the manufacturer's directions for mixing and using these products. After cleaning, be sure to rinse atomizer with warm or hot water and air dry before adding medication.

MODEL 163

This all-purpose atomizer can be used with either oil or aqueous solutions in the nose or throat and is constructed for heat sterilization. The adjustable spray tip can be moved up or down to reach otherwise inaccessible areas in the throat - behind the soft palate or far down the throat. The spray tube (163-TC) can be easily removed for sterilization.

TO USE—To achieve best results, fill the bottle not more than two-thirds full. Push the spray tube firmly into the head of the atomizer so both black o-rings are seated in the atomizer head. Atomizer may be operated with either compressed air or hand bulb. If hand bulb is used, grasp the bulb firmly using the fingers against the palm of the hand, rather than two or three fingers against the thumb.

TO CLEAN—Use a fine wire and follow directions given with illustrations below.



Place a ballpoint pen/key between spray tubes and turn, spreading tubes apart, leaving ballpoint pen/key in place. Remove atomizer tip.

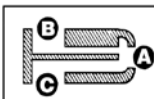

Insert a fine wire into point of tip A, cleaning the two passages shown. Be sure to insert wire until visible in openings B & C.

Disassemble the atomizer by rotating the cap in a counterclockwise direction. The spray tube assembly can be removed from the cap by rotating in a counterclockwise direction.



To replace atomizer tip, attach it to one of the tubes: 1) make sure the GROOVE MARK is on the bottom and 2) turn and remove key. The atomizer tubes will snap into position.

TO STERILIZE—Pull the spray tube forward from the atomizer head. The spray tube is constructed for heat sterilization and there is no danger of impairing the atomizer by boiling. The atomizer can be autoclaved (remove plastisol bulb and black washer). Use 1/2 bleach to 2/3 water for not more than 10-15 minutes. Cidex (2.4% glutaraldehyde solution) may also be used. Be sure to follow the manufacturer's directions for mixing and using these products. After cleaning, be sure to rinse atomizer with warm or hot water and air dry before adding medication.

MODEL 286-RD

NOTE—No. 286-RD and No. 1-RD can be substituted for discontinued No. 251.

This atomizer is designed for spraying solutions which affect metal or which deteriorate in the presence of metal. The straight flow spray tip with which it is equipped makes this atomizer a suitable instrument for treating either the nose or throat.

TO USE—To secure best results, fill bottle not more than two-thirds full. May be operated with either compressed air or a hand bulb. If a hand bulb is used, grasp bulb firmly, using the fingers against the palm of the hand rather than two or three fingers against the thumb.

TO CLEAN—Unscrew and remove spray tip. Run a fine wire down inner tube as far as it will go.

TO STERILIZE—Use 1/2 bleach to 2/3 water for not more than 10-15 minutes. Cidex (2.4% glutaraldehyde solution) may also be used. Be sure to follow the manufacturer's directions for mixing and using these products. After cleaning, be sure to rinse atomizer with warm or hot water and air dry before adding medication. **Do not use heat on plastic parts.**



DeVilbiss Healthcare LLC
100 DeVilbiss Drive
Somerset, Pennsylvania 15501
USA
800-338-1988 • 814-443-4881

- Atomizer Models**
15-RD, 151, 163, 286-RD
- Nebulizer Models**
45, 180, 646
- Powder Blower Models**
119, 175
- Irrigation Syringe Model**
177



A-123 Rev G

MODEL 45

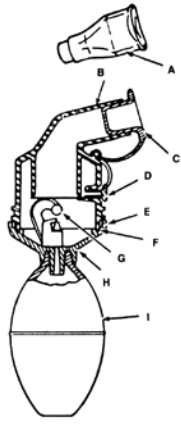

TO USE

1. Remove stopper (C) from vapor tube (B) holding nebulizer in horizontal position, add medication through vapor tube (B). DO NOT FILL ABOVE O-RING (F). OVERFILLING WILL CAUSE NEBULIZER TO LEAK.
2. Remove stopper (D) to attain maximum aerosol delivery. Hold nebulizer in upright position.
3. With mouth fully open, place end of vapor tube (B) just inside lips. Compress bulb firmly and sharply, using the fingers against the palm of the hand. Inhale deeply with each bulb compression.
4. When using with mouthpiece, affix mouthpiece on vapor tube (B). Mouthpiece is to be placed between teeth with lips open **Figure 1**. **NOTE:** The Model 45 nebulizer includes a mouthpiece specifically designed for use with this model. It is not compatible with other sizes of mouthpieces.
5. After using, replace stoppers (C) and (D).

TO CLEAN—For best performance and service life, clean your nebulizer daily.

1. Remove stoppers (C) and (D) from nebulizer ports. Separate nebulizer base (H) and vapor tube (B) at point (E) by unscrewing. Remove medication.
2. With thumb and index fingers, using a lifting motion, carefully remove jet (G).
3. Nebulizer plastic parts and mouthpiece should be rinsed with hot tap water after every use by removing bulb (I) from nebulizer base (H), and cleaned at least once a day. Your physician or dealer may specify a certain cleaning procedure. If so, follow their recommendations.
4. Using two clean plastic containers or bowls, fill one with hot water and dishwashing detergent for washing, the other with hot water and vinegar solution (one part vinegar to three parts water) for soaking.
5. Place nebulizer plastic parts and mouthpiece in bowl of detergent solution and clean thoroughly. Remove and rinse with clear hot tap water (131°F-149°F/55°C-65°C), then soak in vinegar solution (>=5% acetic acid concentration) for 30 minutes. Rinse with hot tap water and air dry.
6. Your nebulizer is constructed of latex-free polycarbonate that, with the exception of the mouthpiece and o-ring, will withstand sterilization by autoclaving (@ 273°F for 15 minutes) or boiling. Nebulizer plastic parts EXCLUDING mouthpiece (A), o-ring (F), and bulb (I) may also be sterilized by boiling.
7. If using medical disinfectant cleaners, follow manufacturer's instructions carefully.
8. Keep the outer surface of the bulb (I) dust-free by wiping with a clean, damp cloth. **CAUTION**—Never permit water or medication to enter bulb as it will cause bulb to become prematurely brittle.
9. After parts are thoroughly dried, reassemble bulb (I) to nebulizer base (H). Carefully replace jet (G) to original position in base with closed part of jet toward throat. Reassemble top portion of nebulizer to nebulizer base.



Figure 1

MODEL 646

Your DeVilbiss nebulizer is designed to produce a dense high-quality aerosol for administration of your prescribed medication. When cared for properly, your nebulizer should give years of dependable service. Please read carefully the following instructions before placing your DeVilbiss nebulizer in operation.

TO FILL

1. Remove port cap and position nebulizer aerosol port in an upward position.
2. Fill nebulizer through main aerosol port with prescribed amount of medication.
3. The nebulizer is designed with a no-spill internal rim to prevent medication from accidentally spilling. Do not fill above o-ring at the base of medication reservoir. Overfilling may cause nebulizer to leak.

TO USE

1. It is important to be in a comfortable upright position during your treatment.
2. Fill nebulizer as previously instructed. Attach mouthpiece to T-piece. **NOTE:** The Model 646 nebulizer includes a mouthpiece specifically designed for use with this model. It is not compatible with other sizes of mouthpieces.
3. Attach nebulizer tubing to a mechanical compressor such as the DeVilbiss 5650, 4650, or 3655 series compressors. If compressed air or oxygen is used, set regulator to permit 5-7 lbs. pressure or a flow of 6-8 liters per minute.
4. To attain maximum aerosol output, remove air vent cap from side vent of nebulizer.
5. Turn on air compressor. Aerosol will not flow until thumb-valve is closed as described below.
6. Position mouthpiece between teeth. Place finger over thumb-valve. As aerosol begins to flow, inhale deeply. At the end of the inhalation, remove finger from thumb-valve and hold breath for two seconds.
7. Remove nebulizer from mouth and exhale slowly. This procedure should be repeated until all prescribed medication is nebulized. **NOTE:** Blow through T-piece Model 646 nebulizer is designed to remain in the mouth during exhalation if desired.
8. Nebulizer may be used without mouthpiece. Position nebulizer aerosol port in mouth so that aerosol avoids teeth and tongue. Follow same administration procedure as described above.

TO CLEAN

1. Remove nebulizer tubing from compressor and nebulizer. Remove mask or mouthpiece.
2. Unscrew upper half of nebulizer from lower half and rinse all parts under hot tap water after every use.
3. Daily, wash nebulizer, jet, mouthpiece, thumb-valve in hot, soapy water. If jet is clogged, use cleaning wire (not shown). Rinse with hot tap water for 30 seconds, then soak in one part white vinegar (>=5% acetic acid concentration) to three parts hot water (131°F-149°F/55°C-65°C) for 30 minutes. Rinse with hot tap water and air dry. Replace or clean tubing monthly by following nebulizer cleaning instructions. To remove excess water from tubing, attach to compressor or air source and allow air to pass through tubing until excess moisture is removed.
4. Your nebulizer is constructed of latex-free polycarbonate that, with the exception of the mouthpiece and o-ring, will withstand sterilization by autoclaving (@ 273°F for 15 minutes) or boiling. It may also be sterilized with any suitable germicidal agent. Always prepare fresh solution for each cleaning cycle.
5. To avoid possible contamination, your nebulizer should be stored with port and vent caps in place until your next treatment.

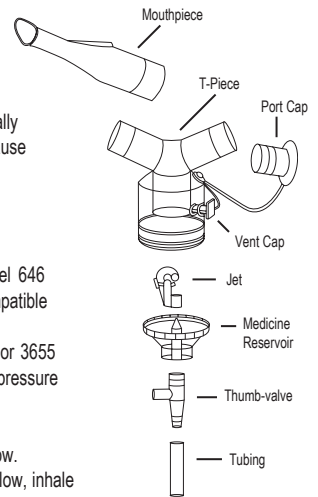

MODEL 180

For Vaporizing Oil or Glycerin-Base Solutions

This nebulizer produces a vapor instead of a spray. It may be used wherever a vapor is indicated, as in treatment of the lower respiratory tract or very sensitive nasal tract. Any deep-seated conditions can be treated with the nebulizer, as the vapor reaches, by inhalation, even the most remote regions to which it is directed.

TO USE

- Use only solutions with an oil or glycerin base. For best results, fill bottle not more than one-quarter full.
- This nebulizer can be operated with either compressed air or a hand bulb. If hand bulb is used, grasp the bulb firmly using the fingers against the palm of the hand, rather than two or three fingers against the thumb.
- For a dry vapor, turn the little metal table inside the bottle to a horizontal position. For a moist vapor, turn it to a perpendicular position.
- Nebulizer is equipped with both a vented and a plain nasal guard. The nasal guard with ventilating grooves prevents any undesirable excess of air pressure in the nasal cavities. This extra low-pressure feature ensures against any possible harm to delicate membranes. The plain guard is for inflation purposes. In attaching either nasal guard to the nebulizer, give it a slight twist to make it fit tightly.

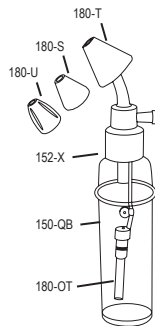

TO CLEAN — Unscrew and remove spray unit from bottle. Unscrew and remove glass tube with its metal ferrule. Wipe the nozzle point clean. If this does not remove obstruction, run a fine wire through the glass tube and metal ferrule. Replace glass tube and screw metal part to bottle.

TO STERILIZE

1. Remove plastic nasal guard.
2. Disassemble the atomizer by rotating the cap in a counterclockwise direction.
3. The spray tube assembly can be removed from the cap by rotating it in a counterclockwise direction.
4. Boil metal parts and plastic guard.

MODEL 119

TO USE—Be sure all parts are dry before using. Fill bottle no more than half way to shoulder of the bottle with dry powder. For measured dosages, add desired amount of dry powder to bottle. Do not over-tighten bottle. Grasp the bulb firmly, using the fingers against palm of hand. If necessary, tube can be unthreaded slightly to administer powder in other directions.

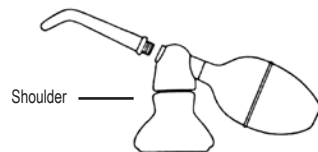

TO CLEAN—If powder is kept dry, there is little chance for clogging. If damp powder remains in the tube and becomes caked, unthread tube and remove residue with pipe cleaner. For best results, remove powder, rinse and thoroughly dry the bottle and tube before storing for extended period of time. Do not store with powder in bottle.

TO STERILIZE—Wipe carefully with gauze or absorbent cotton moistened with alcohol or other germicidal solutions suitable for sterilizing purposes.

CAUTION—DO NOT USE HEAT; it may damage the unit.

MODEL 175

This Powder Blower diffuses powder medication evenly and perfectly. When making application to the ear, the single tube does not obscure the light.

TO USE—Be sure all parts are clean and dry before using. To secure best results, fill bottle not more than two-thirds full. May be operated with either compressed air or a hand bulb. If a hand bulb is used, grasp the bulb firmly, using the fingers against the palm of the hand, rather than two or three fingers against the thumb.

TO CLEAN—Run a pipe cleaner into the tube as illustrated and well up into the head as far as it will go.

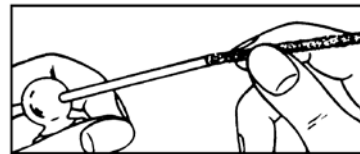

Disassemble the atomizer by rotating the cap in a counterclockwise direction. The spray tube can be removed from the cap by rotating it in a counterclockwise direction.

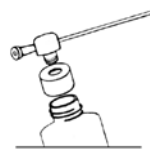

TO STERILIZE—Wipe carefully with gauze or absorbent cotton moistened with alcohol or other germicidal solutions suitable for sterilizing purposes.

MODEL 177

A special feature of this syringe is the small hole in the head, by which the flow of solution can be regulated. Maximum flow is obtained when this hole is covered with a finger. Removing finger stops solution if air-line pressure is twenty psi or less, and reduces flow if air-line pressure exceeds twenty pounds.

TO USE—To secure best results, fill container no more than two-thirds full. Can be operated with either compressed air or hand bulb. If hand bulb is used, give taper connection a slight twist to make it hold securely. Grasp the bulb firmly, using the fingers against the palm of the hand, rather than two or three fingers against the thumb.

This syringe is especially convenient for washing wax out of the ear. Also for general use where controlled stream is desired. Large size 6-ounce bottle holds an adequate supply of liquid.

TO CLEAN—Unscrew and remove syringe tube. Insert a fine wire into the back end of the tube and run it through until it reaches the forward opening. The illustrations below show details of this cleaning operation. **IMPORTANT**—Only a very fine wire should be used in cleaning the tube, as a strong one might push through the forward end, breaking the tip.

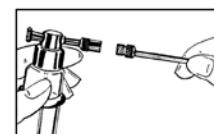

Unscrew and remove syringe tip.

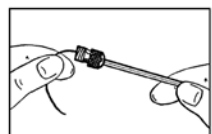

Insert cleaning wire into back end of tube and run it through to forward opening.

TO STERILIZE—Autoclave (remove the plastisol bulb and black washer). Use 1/8 bleach to 2/3 water for not more than 10-15 minutes. Cidex (2.4% glutaraldehyde solution) may also be used. Be sure to follow the manufacturer's directions for mixing and using these products. After cleaning, be sure to rinse atomizer with warm or hot water and air dry before adding medication.

Disassemble the syringe by rotating the cap in a counterclockwise direction. The spray tube assembly can be removed from the cap by rotating it in a counterclockwise direction.

