

Safe and Smart



Large loop for opening or hanging.

Adhesive area on back for hanging up the package.

Sterile water. A press on the water pocket makes the water run down and activate the catheter's surface layer.

Insertion guide. A firm grip without needing to touch the catheter with your fingers.

Hydrophilic catheter with Urotonic[™] Surface Technology for minimal friction during insertion and withdrawal.



Foldable and discreet.

Smooth catheter eyes.

Intended use

The LoFric[®] Primo[™] single use urinary catheter is intended for intermittent urinary catheterisation.

Sterilisation and shelf life

All catheters are sterilised by irradiation. Information about the recommended best before date is printed on the package.

Package

30 catheters per carton and 4 cartons per shipping box.

Material composition

Hydrophilic surface coating: Polyvinyl pyrrolidone (PVP) and sodium chloride (NaCl).

Catheter: Polyolefin-based elastomer, POBE (Nelaton). Polyvinyl chloride, PVC (Tiemann).

Water pocket: Laminate foil of polyethylene terephthalate (PET), polyethylene (PE) and aluminium, sterile water.

Item package: Polyethylene (PE).

Product range PVC FREE

Reference	Type	Length	Size
411 06 00	LoFric [®] Primo [™] Nelaton Paed	20 cm	CH 06
411 08 00	LoFric [®] Primo [™] Nelaton Paed	20 cm	CH 08
411 10 00	LoFric [®] Primo [™] Nelaton Paed	20 cm	CH 10
413 08 00	LoFric [®] Primo [™] Nelaton	20 cm	CH 08
413 10 00	LoFric [®] Primo [™] Nelaton	20 cm	CH 10
413 12 00	LoFric [®] Primo [™] Nelaton	20 cm	CH 12
413 14 00	LoFric [®] Primo [™] Nelaton	20 cm	CH 14
413 16 00	LoFric [®] Primo [™] Nelaton	20 cm	CH 16
413 18 00	LoFric [®] Primo [™] Nelaton	20 cm	CH 18
414 08 00	LoFric [®] Primo [™] Nelaton	15 cm	CH 08
414 10 00	LoFric [®] Primo [™] Nelaton	15 cm	CH 10
414 12 00	LoFric [®] Primo [™] Nelaton	15 cm	CH 12
414 14 00	LoFric [®] Primo [™] Nelaton	15 cm	CH 14
410 08 00	LoFric [®] Primo [™] Nelaton	40 cm	CH 08
410 10 00	LoFric [®] Primo [™] Nelaton	40 cm	CH 10
410 12 00	LoFric [®] Primo [™] Nelaton	40 cm	CH 12
410 14 00	LoFric [®] Primo [™] Nelaton	40 cm	CH 14
410 16 00	LoFric [®] Primo [™] Nelaton	40 cm	CH 16
410 18 00	LoFric [®] Primo [™] Nelaton	40 cm	CH 18

Product range PVC

Reference	Type	Length	Size
966 10 00	LoFric [®] Primo [™] Tiemann	40 cm	CH 10
966 12 00	LoFric [®] Primo [™] Tiemann	40 cm	CH 12
966 14 00	LoFric [®] Primo [™] Tiemann	40 cm	CH 14
966 16 00	LoFric [®] Primo [™] Tiemann	40 cm	CH 16
966 18 00	LoFric [®] Primo [™] Tiemann	40 cm	CH 18

Instructions

Opening 1 (Sterile opening)

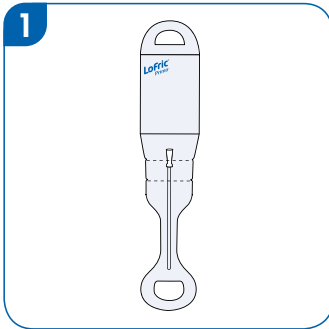

1. Unfold the package. Hold the product upright.

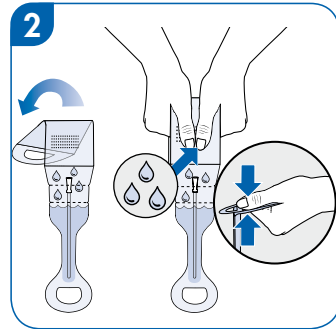

2. Fold the water pocket. Squeeze the water pocket and let the water run down to the catheter.

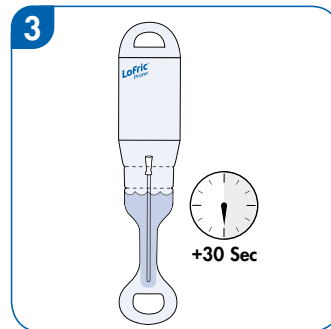

3. Hang LoFric Primo using the upper loops or the adhesive area. Let it soak for 30 seconds while you prepare for insertion.

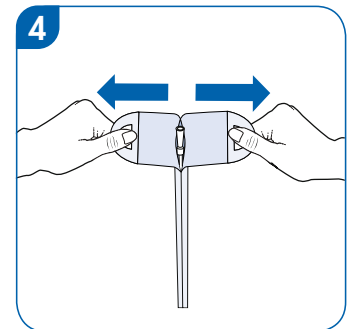

4. Peel open packaging. Grip the package at the loops above the water pocket with both hands. Peel until the connector is exposed. Catheterise.

Opening 2 (Using the insertion guide)

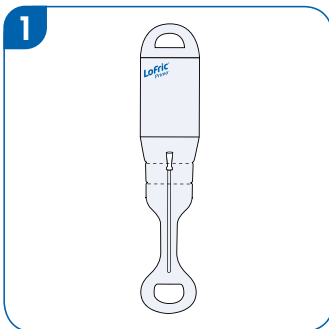

1. Unfold the package. Hold the product upright.

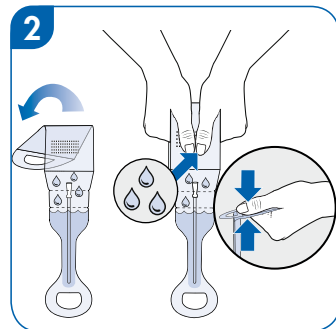

2. Fold the water pocket. Squeeze the water pocket and let the water run down to the catheter.

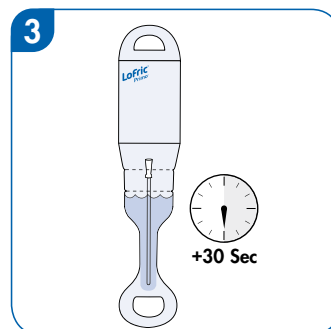

3. Hang LoFric Primo using the upper loops or the adhesive area. Let it soak for 30 seconds while you prepare for insertion.

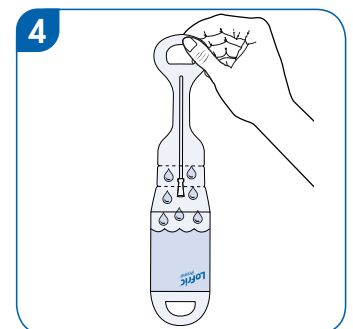

4. Turn the package upside down so the water flows back into the pocket.

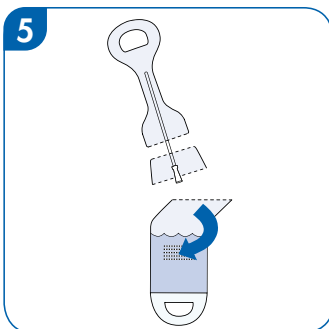

5. Remove the water pocket by tearing at indentation "A".

Hint! Tear half-way first, turn the package and tear the other half. Tear at indentation "B", in the same manner as for indentation "A".

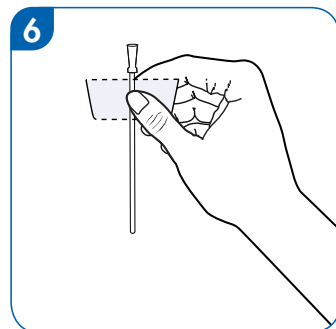

6. Use the remaining packaging part as a handling guide. This part will give you a firm and hygienic grip, allowing you to insert the catheter without touching it.