



MOVING REHABILITATION FORWARD™

## CPM and Homecare | 2013



## INTRODUCTION



Chattanooga is the world's largest manufacturer of rehabilitation equipment for treating musculoskeletal, neurological and soft tissue disorders. For over six decades, Chattanooga has set a benchmark for leadership, reliability and excellence. Our products contribute to better treatment outcomes in hospitals, clinics and home settings worldwide. We lead the rehabilitation industry by example, and through continuous innovation, provide real world solutions for clinicians and their patients.

As the world's leading brand in rehabilitation, Chattanooga is sold in over 80 countries worldwide. Chattanooga distributors and customers are supported by a highly trained and seasoned team of personnel who oversee new product development, product training and education, order placement, product delivery, and after sales service in addition to providing dedicated sales and marketing support.

Chattanooga is a brand of DJO Global Inc. DJO Global provides solutions for musculoskeletal health, vascular health and pain management. Our products help prevent injuries or rehabilitate after surgery, injury or from degenerative disease, enabling patients to regain or maintain their natural motion.

Visit [www.DJOGlobal.com/chattanooga](http://www.DJOGlobal.com/chattanooga)



AIRCAST

chattanooga

CMFV

Compex

djosurgical

DONJOY

Dr. Comfort

Empi

PROCARE

## CPM AND HOMECARE

Chattanooga offers a complete and extensive line of Continuous Passive Motion products to fit every need. Our durable CPMs are designed to hold up to the rigors of the home health market, maintain reliability year after year and lead the industry in ease of use.

The OptiFlex K1 is the latest in a long line of trusted, reliable CPMs. The unit is an easy to maintain, easier to use and features German-made key components. Choices of Classic, Standard and Comfort configurations offer unparalleled flexibility in a single clean-design framework.

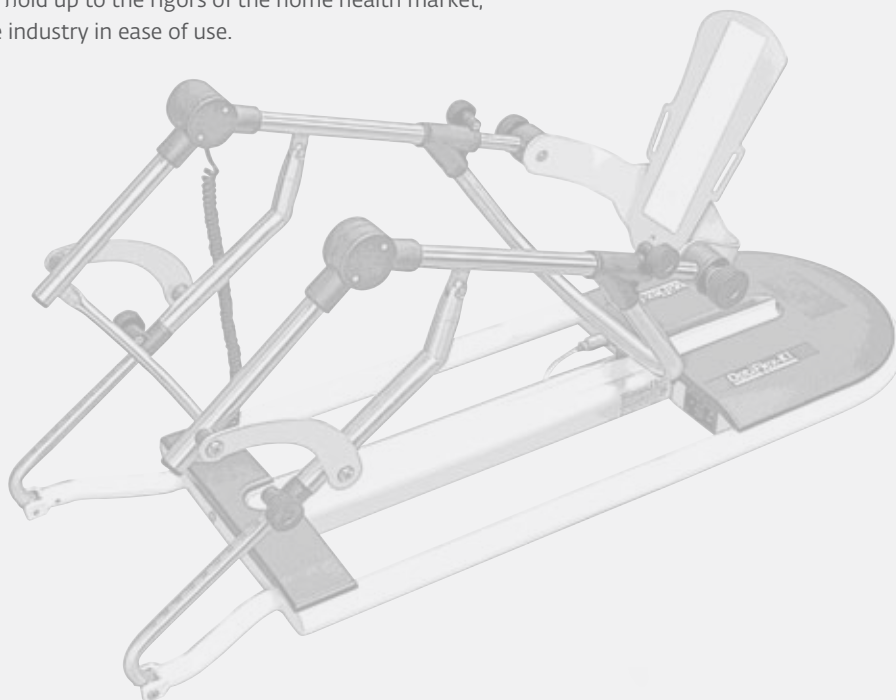



## CONTENTS

Introduction	1
OptiFlex K1 Knee CPM	3
OptiFlex 3 Knee CPM	4
ARTROMOT K3	5
ARTROMOT K4	6
OptiFlex S2 Shoulder CPM	7
Artromot E2 Elbow CPM	8
OptiFlex Ankle CPM	9
CPM Patient Pad Kits and Accessories	10
TENS	11
Saunders Cervical and Lumbar HomeTrac	12
Supports	13-16
Therapeutic exercise	17
Saunders Total Back, Stabilizer	18
Theratherm, Boo Boo Pack, Flexi Pac	19
Compression	20-22

## ORDERING INFORMATION

## Part Number Description

## OptiFlex-K1™

2026 OptiFlex K1 Knee CPM unit

## Standard Accessories

20533 OptiFlex Patient Kit

## TECHNICAL SPECIFICATIONS

## OptiFlex-K1™

Knee Flexion:	120°
Knee Extension:	-10°
Speed:	25° - 180°/minute
Pauses:	0 - 59 seconds
Force Reversal:	45 Kp of force® (built in)
Patient Height:	4ft - 6.6ft (1.2m - 2m)
Calf Length Range:	10" - 22" (25.4-55.9 cm)
Thigh Length Range:	12" - 19" (30.4-48.2 cm)
Mains Power:	100V-240V, AC 50-60Hz
Unit Weight:	23lb (10.4 kg)
Shipping Weight:	54lb (24.5 kg)
Dimensions:	38" x 14" x 9" (97cm x 36cm x 23cm)
Electrical Safety Class:	Class I, Type B

## Safety Tests:

IEC 60601, 1:1988 +A1:1991, +A2:1995,  
CAN/CSA C22.2 NO 601.1 M90,  
ANSI/UL 60601-1, IEC 60601-1-2,  
IEC 60601-1-4, ISO 14971, ISO 10993-1

## OPTIFLEX-K1™



## FEATURES

## OptiFlex-K1™ – Simple, Durable, Reliable.

- Weighs just 23 lbs (10.4 kg), making it the lightest knee CPM on the market
- Only 38 inches (97 cm) long
- Wide low-profile, closed-base frame for stability
- Faster motor speed
- Single screw drive
- Reversible footplate for shorter legs
- ROM -10 to 120
- On-board power supply
- Patient lockout feature
- Accommodates patients 4 ft to 6.6 ft (1.2 m - 2 m)
- Two-year warranty



Reversible footplate

Interchangeable Hand Controls  
for Maximum Versatility

	Classic	Standard	Comfort
Key lock function	✓	✓	✓
Pauses	✓	✓	✓
Speed	✓	✓	✓
Timer		✓	✓
Reverse on load		✓	✓
Warm up protocol		✓	✓
Default setting		✓	✓
Transport setting		✓	✓
Chip card selectable		✓	✓

## Special Functions

EROM repeat			✓
Stretch protocols			✓
Workout protocol			✓
Comfort protocol			✓
Therapy documentation			✓
EMS control			✓

## OPTIFLEX3®



## FEATURES

**OptiFlex3 Knee CPM**

Designed to provide anatomical motion for CPM Knee Patients from Pediatric to Adult

- Easy-to-read backlit display
- On-board power supply along with surface mount electronics to maximize reliability
- Force Reversal safety feature lets you safely set amount of passive force without causing unnecessary post-surgical pain
- Wide carriage – 11" (28 cm) from center of carriage
- Independent delay time
- Patient lockout feature
- Universal left/right design
- Patient compliance/usage meter
- Quick conversion from adult to pediatric
- Two-year warranty

**Patented Features****Progressive ROM™ Auto ROM Increase**

Eliminates time consuming adjustments by automatically increasing daily range of motion.

**Oscillation Zone™ ROM Stretch Repeat**

Allows more time spent in the "active" or "working" range of motion.

**Fast Back™ ROM Accelerator**

Accelerates through non-working ROM while knee spends more time in "active" range of motion.

**Comfort Zone™ ROM Limiter**

Addresses patient pain threshold by providing therapy at a reduced flexion angle limit.

## ORDERING INFORMATION

**Part Number Description****OptiFlex3 Knee CPM**

2090K OptiFlex3 Knee CPM unit, includes one patient kit

**Standard Accessories**

20533 OptiFlex Patient Kit

## TECHNICAL SPECIFICATIONS

**OptiFlex-K1™**

Knee Flexion:	120°
Knee Extension:	-10°
Speed:	30° - 150°/minute
Pauses:	0 - 30 seconds
Force Reversal:	35 - 75 lb (16 - 34 kg)
Maximum Patient Weight:	350 lb (159 kg)
Calf Length Range (knee joint to sole of foot):	10" - 23.5" (25.4 - 59.7 cm)
Thigh Length Range:	12" - 19" (30.5 - 48.3 cm)
Mains Power:	100 - 240 V, 50/60 HZ
Unit Weight:	27 lb (12 kg)
Shipping Weight:	41 lb (18.6 kg)
Length:	37" (94 cm)
Electrical Safety Class:	Class 1, Type B
Safety Tests:	UL/IEC/EN 60601-1, IEC/EN 60601-1-2:2001

The OptiFlex3 Knee CPM is protected by one or more of the following patents:

6,217,532 B1 6,221,032 B1  
6,221,033 B1 6,267,735 B1  
D437, 014 S

## ORDERING INFORMATION

### Part Number Description

#### ARTROMOT K3 Knee CPM

2043 ARTROMOT K3 Knee CPM

#### Patient Kit (not shown)

20710 K3 Fleece Patient Kit Also fits Danninger 400 Series

## TECHNICAL SPECIFICATIONS

### ARTROMOT K3

Extension/Flexion:	-5 - 0 - 110°
Pauses:	0 - 30 sec.
Speed:	18° - 180°/minute
Warm-up Mode:	50% of programmed ROM
Reverse-on-load:	25 - 45 Kp of force*
Therapy Run Time:	h : m
Unit Weight:	24.4 lbs (11 kg)
Shipping Weight:	51 lbs (23 kg)
Dimensions:	17" x 14.2" x 36.6" (43 cm x 36 cm x 93 cm)
Safety Tests:	CSA - 601-1-M90, UL - 2601-1

\* Kp = 2.2 lbs of force

## ARTROMOT® K3 KNEE CPM



## FEATURES

### ARTROMOT® K3 Knee CPM

- Handheld programming of device parameters: extension, flexion, pause, force and speed
- Four hidden programming features: Warm-up, Patient runtime, Device runtime, Full speed and motion
- Wide, deep leg orthosis to accommodate larger patients
- Quick conversion from adult to pediatric set-up
- Reliable solid-state digital electronics
- Wide, stable skid-resistant base
- Removable power cord
- Two-year warranty



Reversible footplate



K3 Fleece Patient Kit

## ARTROMOT® K4 KNEE CPM



### FEATURES

#### ARTROMOT® K4 Knee CPM

German designed and engineered for effective post-operative range of motion for the knee and hip joint with minimal adjustments for easy operation. The K4 features a true anatomical hip axis providing precise knee and hip motion. Lifting, transporting and storage are a cinch with the "grab easy" base design..

- K4 features true anatomical hip axis providing precise knee and hip motion
- Handheld programming of device parameters: extension, flexion, pause, force and speed
- Four hidden programming features: Warm-up, Patient runtime, Device runtime, Full speed and motion
- Wide, deep leg orthosis to accommodate larger patients
- Quick conversion from adult to pediatric set-up
- Reliable solid-state digital electronics
- Wide, stable skid-resistant base
- Removable power cord
- Two-year warranty



Reversible footplate

### ORDERING INFORMATION

Part Number	Description
<b>ARTROMOT K4 Knee CPM</b>	
2044	ARTROMOT K4 Knee CPM
<b>Patient Kit (not shown)</b>	
2071	Fleece Patient Kit K4 Also fits Danninger 500 Series

### TECHNICAL SPECIFICATIONS

#### ARTROMOT K4

Extension/Flexion:	-10 - 0 - 125°
Pauses:	0 - 30 sec.
Speed:	18° - 180°/minute
Warm-up Mode:	50% of programmed ROM
Reverse-on-load:	25 - 45 Kp of force*
Therapy Run Time:	h : m
Unit Weight:	26 lbs (12 kg)
Shipping Weight:	51 lbs (23 kg)
Dimensions:	21.7" x 15.5" x 45.2" (55 cm x 39 cm x 115 cm)
Safety Tests:	CSA - 601-1-M90, UL - 2601-1

\* Kp = 2.2 lbs of force

## ORDERING INFORMATION

## Part Number Description

## OptiFlex S Shoulder CPM

2029 OptiFlex S Shoulder CPM

## Standard Accessories

34273 Control pendant

20661 Patient data chip card (1x)

## Optional Accessories

20719 Grey Fleece Patient Kit (not shown)

## FUNCTIONS

## OptiFlex® S Shoulder CPM

Motor Control On/Off

Pause 0 - 30 sec.

Speed 0 - 100%

Timer 1 - 300 min.

Warm-up Mode 50% of programmed ROM

Synchronization On/Off

Reverse-on-load 1 - 20

Therapy Run Time h : m

Patient Data Storage

## TECHNICAL SPECIFICATIONS

## OptiFlex® S Shoulder CPM

Adduction/Abduction: 0 - 30 - 175°

Internal/External Rotation: 90 - 0 - 90°

Flexion/Extension: 0 - 30 - 175°

Horizontal Adduction/Abduction: 0 - 0 - 125°

Weight: 55 lbs (25 kg)

Shipping Weight: 107 lbs (48.5 kg)

Dimensions: 34.4" x 22.6" x 22.8"  
(87.5 cm x 57.5 cm x 58 cm)Transport Size: 14.6" x 22.6" x 22.8"  
(37 cm x 57.5 cm x 58 cm)

Safety Tests: CSA - 601-1-M90, UL - 2601-1

## OPTIFLEX® S SHOULDER CPM



## FEATURES

## OptiFlex® S Shoulder CPM

Designed to provide anatomical motion for the shoulder with enhanced patient comfort, compliance and more beneficial outcomes. Addresses full range of motion capabilities. OptiFlex S brings you the apex of modern, easy-to-use technology with the Patient Data Chip Card. This compact chip card stores individual treatment data and patient compliance. It is the size of a credit card and slides easily into the pendant to control the precise angles, speed and motion.

- Easy-to-use hand control for storing treatment data on memory chip card
- Fully synchronized motors allow treatment parameters to be customized to meet patient's specific therapy protocols
- Ergonomic rest for healthy arm and fully adjustable chair
- Patented Universal left/right Shoulder design
- Folds easily for transport/shipping
- Includes patient data card and erasable pen
- Lightweight design weighs 55 lbs (25 kg)
- Two-year warranty



Adduction/Abduction



Internal/External Rotation



Flexion/Extension



Physiological Movement

OptiFlex S brings you the apex of modern, easy-to-use technology with the Patient Data Chip Card. This compact chip card stores individual treatment data and patient compliance. It is the size of a credit card and slides easily into the pendant to control the precise angles, speed and motion.



## ARTROMOT® E2 ELBOW CPM



### FEATURES

#### ARTROMOT® E2 Elbow CPM

Artromot E2 Compact Elbow CPM provides anatomical motion for the elbow and enhances patient comfort and compliance. The Artromot Elbow CPM addresses full range of motion capabilities – Pronation/ Supination and Flexion/Extension.

- Fully synchronized motors allow treatment parameters to be customized to meet patient's specific therapy protocols
- Easy-to-use hand control capable of storing treatment data on memory chip card
- True physiological movements with the greatest range of motion
- Anatomically correct adjustments
- Easy to transport
- Lightweight 35 lbs (16 kg)
- Two-year warranty



Extension/Flexion

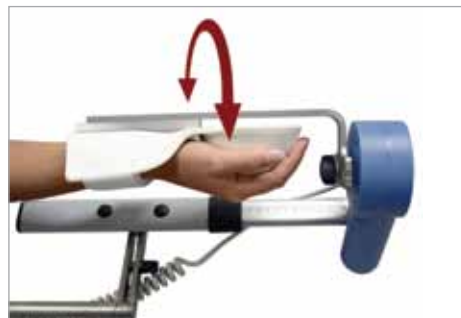

Pronation/Supination

### ORDERING INFORMATION

Part Number	Description
<b>ARTROMOT® E2 Elbow CPM</b>	
2038	Artromot E2 Compact Elbow CPM Unit
<b>Standard Accessories</b>	
20723	Elbow Patient Kit
20661	Patient Data Chip Card (1x)

### TECHNICAL SPECIFICATIONS

#### OptiFlex-K1™

Extension/Flexion:	-5 - 140°
Pronation/Supination:	-90 - 90° (Manual Setup)
Motor Control:	On/Off
Pauses:	0 - 30 sec.
Speed:	0 - 100%
Timer:	1 - 300 min.
Warm-up Mode:	50% of Programmed ROM
Synchronization:	On/Off
Reverse-on-load:	1 - 25
Therapy Run Time:	h : m
Display Contrast:	
New Patient Data Storage:	
Unit Weight:	35.2 lbs (16 kg)
Shipping Weight:	54 lbs (24.5 kg)
Dimensions:	30.7" - 40.9" x 23.6" x 31.5" (84 - 104 cm x 60 cm x 80 cm)
Safety Tests:	CSA - 601-0-M90, UL - 2601-1

**ORDERING INFORMATION****Part Number Description****OptiFlex® Ankle CPM**

2027 OptiFlex Ankle CPM Unit includes washable patient kit

**Standard Accessories**

20716 Ankle Patient Kit

20661 Patient Data Chip Card (1x)

**TECHNICAL SPECIFICATIONS****OptiFlex® Ankle CPM**

Dorsal/Plantar Flexion: 40 - 0 - 60°

Inversion/Eversion: 40 - 0 - 20°

Speeds: 2

Unit Weight: 24.25 lbs (11 kg)

Shipping Weight: 46 lbs (21 kg)

Dimensions: 22" x 18.5" x 28.4"

**OPTIFLEX® ANKLE CPM****FEATURES****OptiFlex® Ankle CPM**

The OptiFlex Ankle CPM provides anatomical motion for the ankle to enhance patient comfort and compliance. Addresses full ankle range of motion capabilities – Dorsi Flexion/Plantar Flexion and Inversion/Eversion.

- Easy-to-adjust motors allow treatment parameters to be customized to meet patient's specific therapy protocols
- Easy-to-use hand control capable of storing treatment data on memory chip card
- Adjustable base for use in bed or chair
- Patented Universal left/right design
- Provides anatomically correct motion
- Lightweight 24 lbs (11 kg)
- Two-year warranty



Inversion



Eversion



Dorsi Flexion/Plantar Flexion

## CPM PATIENT KITS AND ACCESSORIES



Seven different sizes of blue vinyl and four sizes of black polyurethane ensure effective cold therapy for any body area or shape.



## ORDERING INFORMATION

Part Number	Description
<b>CPM Patient Kits and Accessories</b>	
A 20533	OptiFlex Patient Kit
B 20710	K3 Fleece Patient Kit
C 20711	K4 Fleece Patient Kit
D 4520	OptiFlex Hi-Lo Trolley
E 20719	S3 Fleece Patient Kit
F 20716	SP2-2M Ankle Patient Kit
G 20723	E2 Elbow Patient Kit
<b>Accessories (not shown)</b>	
40128	34" Strap Kit
11432	Breg®/OptiFlex® CPM Economy Kit

## FEATURES

### CPM Patient Kits and Accessories

Each patient kit is manufactured with attention to quality and comfort. Deep pile sheepskin, durable fleece and soft foam fill ensures patient comfort and proper positioning during therapy. In addition to custom designed patient kits for OptiFlex and Artromot, we manufacture patient kits that may be used with Kinetec®, AutoFlex® and Breg® Flexmate CPM equipment. This broad range of CPM products and accessories makes Chattanooga the complete provider of your CPM needs.

### OptiFlex Hi-Lo Trolley

- Adjustable height from 18.25" to 28"
- Allows for proper positioning of CPM
- Ease of storage and transportation

## ORDERING INFORMATION

## Part Number Description

## Intelect TENS

A 7770	Intelect TENS Basic
B 77600	Intelect TENS Standard
C 7772	Intelect TENS Digital

## Intelect NMES

D 7775	Intelect NMES Standard
E 7777	Intelect NMES Digital

## Intelect IFC

F 7779	Intelect IFC Portable
--------	-----------------------

## Batteries (not shown)

77609	Rechargeable NiCd 9-volt Battery
77610	Battery Recharger

## Lead Wires (not shown)

77593	Lead Wire, TENS 360° Pivot, Unshielded Connector (Pair)
77594	Lead Wire, TENS 360° Pivot, Shielded Connector (Pair)
77595	Lead Wire, TENS Non-Pivot, Shielded Connector (Pair)

## TECHNICAL SPECIFICATIONS

## TENS Economy, TENS Standard &amp; TENS Digital

Channel:	Dual, isolated
Waveform:	Asymmetric biphasic square pulse
Pulse Amplitude:	0-80 mA each channel adjustable (500 ohm load)
Pulse Width:	60-250 $\mu$ sec. adjustable (Economy & Standard)
Pulse Width:	50-300 $\mu$ sec. adjustable (Digital)
Pulse Frequency:	50-300 $\mu$ sec. adjustable (Digital)

## NMES Portable - Standard and Digital

Channel:	Dual, isolated
Waveform:	Asymmetric biphasic square pulse
Pulse Amplitude:	0-80 mA each channel adjustable (500 ohm load)
Pulse Width:	250 $\mu$ sec. (Standard)
Pulse Width:	50-300 $\mu$ sec. adjustable (Digital)
Pulse Frequency:	5, 30, 100 Hz (Standard)
Pulse Frequency:	2-120 Hz, adjustable (Digital)

## IFC

Channel:	Single for 2 pole or Dual for 4 pole
Waveform:	Symmetric biphasic square
Pulse Amplitude:	0-32 mA, adjustable (at 500 ohm load)
Pulse Width:	125 $\mu$ sec./phase
Pulse Frequency:	4000 $\pm$ 10% Hz fixed

\* Dimensions are listed as L x W x H

All Portable Units (A-F) on this page carry a One-Year Warranty

## INTELECT® PORTABLE ELECTROTHERAPY



## FEATURES

Long known for innovative clinical electrotherapy, Chattanooga offers you a full line of portable electrotherapy products with Intelect TENS units, Intelect NMES (Neuromuscular Electrical Stimulation) and Intelect IFC (Interferential Current) units. Treat multiple patient needs from pain management to the prevention or retardation of disuse muscle atrophy. All devices come with lead wires, 9-volt battery, DURA-STICK® Self-Adhesive Electrodes and a convenient carrying case.



## FEATURES

## A-C Intelect TENS

- Dual Independent Channels
- Adjustable Timer on Standard and Digital units
- Adjustable Frequency and Pulse Duration parameters
- Basic and Standard units feature three modes: Burst, Normal and Modulation
- Digital unit features five modes: Burst, Normal, Modulated Rate and Width, Strength Duration and Bi-Pulse
- Digital unit has easy-to-read LCD display and convenient digital controls

## D-E Intelect NMES

- Dual Independent Channels
- Adjustable Pulse Amplitude, Pulse Frequency and Contraction/Relaxation Time parameters
- Digital unit features
  - Adjustable Pulse Width and Timer parameters
  - Three stim modes: Synchronous, Constant and Alternate
  - Easy-to-read LCD display and convenient digital controls

## F Intelect IFC

- Dual Channel, Manual Selection for two or four Electrodes
- Adjustable Pulse Amplitude, Interference Frequency and Difference Frequency parameters
- Four stimulation modes (frequency shifts): Continuous, 1/1, 8/8 and 10/10 Ramped
- Includes 120V AC line cord adapter
- Sliding cover for controls and battery

## SAUNDERS® CERVICAL TRACTION



Safe, Effective Home Treatment



### FEATURES

#### Safe

- A proven alternative to surgery for some patients
- Traction forces are directed to the back of the head to prevent compression of the TMJ
- Easy-to-read pressure gauge provides total control of the force at all times
- Blow-off valve limits the amount of force that can be applied

#### Effective

- A cost effective option to continuous clinical care
- Innovative design replicates clinical traction and promotes consistency of treatment
- Positioning alternatives allow varying treatment options for the clinician
- Patented pneumatic system ensures reliable force accuracy and leak-free performance

#### Easy to Use

- A portable treatment solution that increases patient compliance and satisfaction
- Patented self-adjusting neck wedges ensure a perfect fit
- Patented pump design incorporates a simple “click in place” mechanism
- Quick and simple patient set-up enables home traction without assistance

## SAUNDERS® LUMBAR TRACTION

Affordable High-Quality Home Traction



### FEATURES

#### Safe

- A proven alternative to surgery for some patients
- Friction-free surface ensures smooth motion
- Easy-to-read pressure gauge provides total control of the force at all times
- Blow-off valve limits the amount of force that can be applied

#### Effective

- A cost effective option to continuous clinical care
- Split table design replicates clinical traction and promotes consistency of treatment
- Actively moving treatment surface ensures efficient application of traction
- Patented pneumatic system ensures reliable force accuracy and leak-free performance

#### Easy to Use

- A portable treatment solution that increases patient compliance and satisfaction
- Comes complete — no assembly required
- Non-slip harnesses incorporate belt-organizers for quick set-up
- Patented pump design incorporates a simple “click in place” mechanism

### ORDERING INFORMATION

Part Number	Description
-------------	-------------

#### Saunders® Cervical Traction

199594	Saunders Cervical Traction
--------	----------------------------

#### Saunders® Lumbar Traction

199603	Saunders Lumbar Traction
--------	--------------------------

## ORDERING INFORMATION

## Part Number Description

## Sacroiliac Belt

650306-200	Small 26"-32" Hips (without pad)
650306-300	Medium 32"-42" Hips (without pad)
650306-400	Large 42"-52" Hips (without pad)
650307-001	Stabilization Pad

## Mens S'port® All

200128MW	S'port® All Back Support Mens White Small
200132MW	S'port® All Back Support Mens White Medium
200136MW	S'port® All Back Support Mens White Large
200140MW	S'port® All Back Support Mens White Extra Large
200144MW	S'port® All Back Support Mens White 2X Large

## Women's S'port® All

200128WW	S'port® All Back Support Womens White Small
200132WW	S'port® All Back Support Womens White Medium
200136WW	S'port® All Back Support Womens White Large
200140WW	S'port® All Back Support Womens White Extra Large
200144WW	S'port® All Back Support Womens White 2X Large

## SACROILIAC BELT



Can be used with or without Stabilization Pad

## FEATURES

## Sacroiliac Belt

- Non-slip belt stays put below the ASIS and across the PSIS — even with activity
- Belt conforms to the natural contours of the pelvis, yet still provides the rigid support the SI joint needs
- Newly designed stabilization pad fits between sacral sulci and provides firm, comfortable support and proprioceptive input to sacral area
- Comfortable, plush fit

## S'PORT® ALL BACK SUPPORT



## FEATURES

## S'port® All Back Support

- Low Back Pain Relief & Support During Activities
- Great for Golf & All Sports
- 3% Nylon/17% Spandex athletic short for cooling comfort and soothing compression
- Removable double side-pulls allow minimum or maximum support
- Adjust side pulls higher for lumbar support, lower for sacroiliac support
- Flexible stays provide comfortable, yet firm support
- Patented "stay in place" design lets you move but provides excellent support

## WORK S'PORT® BACK SUPPORT



### FEATURES

#### Work S'port® Back Support

- Low back pain relief & support during work activities
- Patented anchor belt threads easily through belt loops to hold the support in place
- Double side pull adjusts easily
- Flexible stays provide comfortable, yet firm support
- Patented "stay in place" design lets you move but provides excellent support
- Adjusts from firm to gentle support, without awkward suspenders
- Ventilated elastic keeps you cool and comfortable
- Available in black only



## STORK S'PORT®

### FEATURES

#### Stork S'port®

- No uncomfortable stays or hard inserts
- Uses the force of gravity to promote correct posture and gently support the low back, pelvis and abdomen during pregnancy
- Supports under, not over, the abdomen to provide maximum relief with optimal safety and comfort
- Does not require a stabilization strap above the abdomen
- Easiest application of any maternity support: Attach the backside panels to the front abdominal pad and adjust the side pulls
- Adjustable loop closure with nylon lining allows easy adjustment for an accurate fit



## POSTURE S'PORT®

### FEATURES

#### Posture S'port®

The Posture S'port is unique because it anchors at the waist and not only discourages stooped shoulders, but assists in proper spinal alignment. The Posture S'port can be worn directly on the skin or over a t-shirt.

- Criss-crossed suspender like straps gently pull the shoulders back into the neutral position to decrease back and shoulder pain
- Soft cotton underarm pads provide a comfortable fit that won't pinch or bind
- Can be worn directly on skin or over clothing
- Adjustable elastic 4" waistband that anchors the entire support to the waist



## ORDERING INFORMATION

Part Number	Description
-------------	-------------

#### Work S'port® Back Support

200230	Work S'port® Back Support Black Medium
200236	Work S'port® Back Support Black Large
200244	Work S'port® Back Support Black Extra Large

#### Stork S'port®

650309-001	Small/Medium
650309-002	Large/X-Large

#### Posture S'port®

650308-200	Small 22" - 30" Waist
650308-300	Medium 30" - 42" Waist
650308-400	Large 42" - 54" Waist

*Dress size before pregnancy: Small/Medium (4-14), Large/X-large (15-20)*

## ORDERING INFORMATION

Part Number	Size	Chest	Bicep
<b>Sully® Shoulder Support</b>			
660087-001	X-Small	34"-40"	9"-10½"
660087-002	Small	34"-40"	11"-13"
660087-003	Medium	38"-42"	13"-15"
660087-004	Large	42"-46"	14"-17"
660087-005	X-Large	45"-51"	15"-17"

## SULLY® SHOULDER SUPPORT



## FEATURES

**Sully® Shoulder Support**

On the outside, elastic straps attach with hook to the neoprene at any point, in any direction, and with any amount of force you choose. You can functionally stabilize, assist or restrict movement according to the specific needs of each athlete.

On the inside, the perforated, breathable, rubber-like neoprene grips the skin so the support moves with the athlete. It's as if the stabilization straps are attached directly to the body.

The Sully comes complete with a highly adaptable, bifurcated neoprene strap, and two additional 4" neoprene straps. Worn by professional and amateur athletes in all sports! Measure biceps in a non-flexed position.

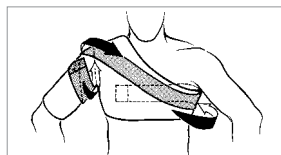
**Multiple Applications**

Posterior Instabilities

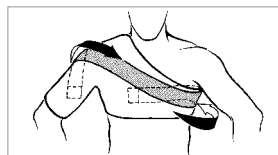

Muscle Strains (pectoral etc.)

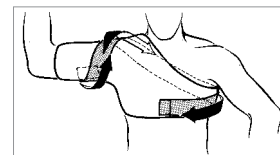

Rotator Cuff Deceleration

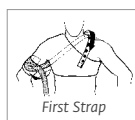

First Strap

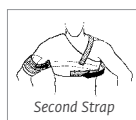

Second Strap

Anterior Instabilities

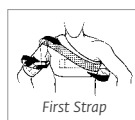

First Strap



Second Strap

Inferior Instabilities

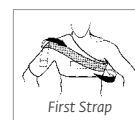

First Strap

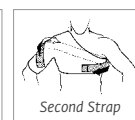

Second Strap

Multi-Directional Instabilities



## SULLY® AC



### FEATURES

#### Sully® AC

The breathable, hook-sensitive neoprene vest grips the skin to allow precise placement of the donut-shaped foam pad. The hard-shelled foam pad helps protect the AC joint from further injury. Simply apply adhesive backed hook to the foam pad to prevent migration. No restrictive and uncomfortable straps are necessary!

Universal design fits both right and left shoulder. Comes complete with vest, pad and adhesive-backed hook material. Pad is also sold separately and can also be used with the Sully Shoulder Stabilizer.

Measure chest circumference for sizing (inches).



### ORDERING INFORMATION

Part Number	Description	Chest
<b>Sully® AC</b>		
43875S	Small	34" - 38"
43875M	Medium	38" - 42"
43875L	Large	42" - 46"
43875XL	X-Large	45" - 51"
43871	Sully AC Pad Only	
Part Number	Description	Waist Size
<b>Sully® AC</b>		
43850XS	X-Small	24" - 27"
43850S	Small	28" - 31"
43850M	Medium	32" - 35"
43850L	Large	36" - 39"
43850XL	X-Large	40" - 44"
43850XXL	XX-Large	45" - 49"

## SULLY® HIP S'PORT®

### FEATURES

#### Sully® Hip S'port®

On the outside, hook sensitive plush material allows attachment of elastic straps in almost any position. Attach the straps at any point, in any direction, and with any amount of force needed. You can functionally stabilize, assist or restrict movement just like with the Sully Shoulder Stabilizer.

On the inside, comfortable, nylon-lined neoprene support moves with the athlete. Easy to apply - no assistance required. Includes two, 5" x 44" straps and a protective, closed-cell foam pad for use with hip pointers or thigh bruises.

For sizing, use waist measurement.



Actual product is black

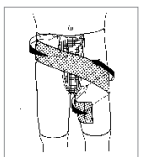

Hip Flexor Strain, Hamstring Pull

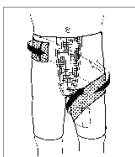

Groin Pull

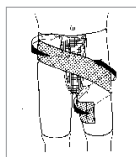

Hip Pointer

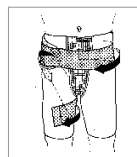

Thigh Bruise,  
Quad Pull

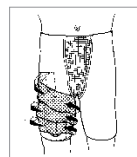

Hip Abduction  
Assist, Flexion or  
Extension Assist

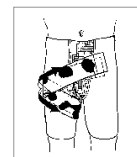

## ORDERING INFORMATION

## Part Number Description

## Chattanooga Standard Exerciser™

18000 Retail Package

18020 Standard Package

## Chattanooga Deluxe Exerciser™

18010 Chattanooga Deluxe Exerciser

## CHATTANOOGA STANDARD EXERCISER™



## FEATURES

## Chattanooga Standard Exerciser™

- Perfect for upper or lower body exercises
- Extremely lightweight: 5 lbs (2.25 kg)
- Wrap-around foot straps
- Comes completely assembled
- Retail packaging available
- Shipping dimensions: 9" x 16" x 45"
- One-year warranty



## CHATTANOOGA DELUXE EXERCISER™

## FEATURES

## Chattanooga Deluxe Exerciser™

- Use for upper or lower body exercises at home, the office or while traveling
- Automatic, multi-functional electronic monitor with LED display
- Quick dial with variable resistance
- Shipping dimensions: 18" x 9.5" x 12.5"
- One-year warranty



## SAUNDERS® TOTAL BACK EXERCISE DEVICE



### FEATURES

#### Saunders® Total Back Exercise Device

Promotes strength, flexibility and coordination through controlled functional exercise

- Pelvic stabilization allows isolation of lumbar extensors in any range of motion
- Adjusting the table angle allows either mild exercise in a pain free range, or intense conditioning
- Angle of recline reduces the load on the spine by 20% to 30% and allows for spinal positions in flexion, extension or side lying through a range of 110°
- "Side sit-ups" are great for the obliques, transversus abdominus, multifundus, quadratus lumborum and erector spinae muscles
- Includes a full-size wall poster feature 28 numbered exercises



## STABILIZER™

### FEATURES

#### Stabilizer™

The Stabilizer Pressure Biofeedback unit gives valuable information to ensure quality and precision in exercise performance and muscle testing. It allows the clinician and patient to determine if the patient is able to selectively isolate and maintain contractions of the cervical or lumbopelvic core stabilization muscles. The measuring range is 0-200 mmHg analog pressure with an accuracy of +/- 3 mmHg pressure.

- Use with exercise to protect and stabilize joints
- Prevent and treat low back and neck pain
- Improve core stabilization exercises
- Enhance home exercise programs



### ORDERING INFORMATION

Part Number	Description
-------------	-------------

#### Saunders® Total Back Exercise Device

640243-002	Saunders Total Back Black
640243-003	Saunders Total Back Imperial Blue
640243-005	Saunders Total Back Burgundy

#### Stabilizer™

9296	Stabilizer Unit Comes complete with display gauge, pressure cell and instruction booklet.
------	--

**ORDERING INFORMATION**

**Part Number Description**

**Theratherm Digital Moist Heat Pack**

1030	Small 7" x 15" (18 cm x 38 cm)
1031	Medium 14" x 14" (36 cm x 36 cm)
1032	Standard 14" x 27" (36 cm x 68 cm)
1033	Shoulder/Neck 23" x 20" (58 cm x 50 cm)

**Replacement Flannel Covers**

13330	Small 7" x 15" (18 cm x 38 cm)
13331	Medium 14" x 14" (36 cm x 36 cm)
13332	Standard 14" x 27" (36 cm x 68 cm)
13343	Shoulder/Neck 23" x 20" (58 cm x 50 cm)

**L boo-boo pac**

Shipped in a display box containing 12 packs.  
NOTE: Must be purchased in quantities of 12 each

1534	Royal Blue boo-boo pac (12 per case)
------	--------------------------------------

**M FlexiPac Hot & Cold Compresses**

4026	5" x 6" (13 cm x 15 cm) 48/case
4020	5" x 10" (13 cm x 25 cm) 24/case
4029	8" x 14" (20 cm x 35 cm) 12/case
4032	5" x 10" (13 cm x 25 cm) 25/case Chiropractically Yours (not shown)

**N Sport-Pac**

Shipped in a display box containing 10 packs.  
NOTE: Must be purchased in quantities of 10 each

1517	Sport-Pac (10 per case)
------	-------------------------

**THERATHERM® DIGITAL MOIST HEAT PACK**

**FEATURES**

**Theratherm® Digital Moist Heat Pack**

Theratherm Digital Moist Heat Pack provides intense, moist heat therapy for temporary relief from pain associated with arthritis, back pain caused by muscle spasm and inflammation caused by strain and tension. Its flannel cover draws moisture from the air and as the pack's temperature rises, the moisture is released onto the skin, speeding relief to your patients. Its unique, easy-to-use digital control is convenient and safe.



- Convenient preset time and temperature
- Digital hand control for operator to program and monitor temperature and/or treatment time
- Lockout mode protects against inconsistent setting changes throughout treatment sessions
- Moist heat therapy temperatures range from 88° to 166° F (32° to 74° C)
- Treatment sessions up to 60 minutes
- Specially designed flannel cover for efficient moisture retention
- UL and cUL classified
- One-year warranty

**BOO-BOO PAC™, FLEXIPAC®, SPORT-PAC™**



**FEATURES  
boo-boo pac**

- Fun, bear-shaped design especially made for kids
- Ideal for pediatric applications
- Filled with non-toxic silica gel
- Delivers up to 30 minutes of soothing relief from acute pain, swelling and fever
- Shipped in a display box containing 12 packs

**FlexiPac**

- Freezable to provide penetrating cold therapy
- Microwavable for soothing heat
- Flexible gel conforms to any body contour at any temperature

**Sport-Pac**

- Soccer ball design is ideal for youth sport applications
- Easily transferred from the freezer to the team cooler for sideline use
- Delivers up to 30 minutes of effective cold therapy for acute pain due to strains, sprains and bruises
- Shipped in a display box containing 10 packs

## PRESSSION® MULTI 3



### FEATURES

#### PresSsion® Multi 3

- Use with either uniform (single) or three chambered garments
- Simple pre-set inflate (35 sec) and deflate (10 sec) times
- Clinical or home use
- Two-year warranty



## PRESSSION® MULTI 6

### FEATURES

#### PresSsion® Multi 6

- Use with either six chamber or some three chamber garments
- Therapy timer from 15 to 120 minutes
- Adjustable inflation/deflation times
- Clinical use
- Two-year warranty



### ORDERING INFORMATION

Part Number	Description
<b>PresSsion® Multi 3</b>	
4331	PresSsion Multi-3 Three Chamber Sequential Unit 120V
<b>PresSsion® Multi 6</b>	
4333	PresSsion Multi-6 Six Chamber Sequential Unit 120V
<b>PresSsion Hose Sets</b>	
43097	6 chamber hose set for use with Multi 6
43096	3 chamber hose set for use with Multi 3

### TECHNICAL SPECIFICATIONS

<b>PresSsion® Multi 3</b>	
Pressure	30-100 mmHg (+/- 5 mmHg)
Inflation	35 seconds
Deflation	10 seconds
Timer	User controlled
<b>PresSsion® Multi 6</b>	
Pressure	30-100 mmHg (+/- 5 mmHg)
Inflation	5-120 seconds
Deflation	5-60 seconds
Timer	15-120 min

**ORDERING INFORMATION**

Part Number	Description
<b>Uniform PresSsion® Single Chamber Garments</b>	
<b>A</b> 43016	Foot and Ankle 10" (25 cm)
<b>B</b> 43019	Full Leg 29" (74 cm)
43020	Full Leg 32" (81 cm)
43021	Full Leg 35" (89 cm)
43023	Full Leg Wide 35" (89 cm)
43017	Half Leg 20" (51 cm) (not shown)
43018	¾ Leg 26" (66 cm) (not shown)
<b>C</b> 43013	Half Arm 17" (43 cm)
<b>D</b> 43014	Full Arm 29" (74 cm)

**PRESSION® GARMENTS**



**FEATURES**  
**PresSsion® Garments**

Made of strong, lightweight, nylon reinforced, washable polyurethane, these garments feature a flexi-walled inflation socket and connector that assures secure hose retention and prevents air shut-off even if the hose is kinked or flattened. Garment extenders are available from 3" to 6" (8 cm to 15 cm) wide for all garments.

**UNIFORM PRESSION® SINGLE CHAMBER GARMENTS**

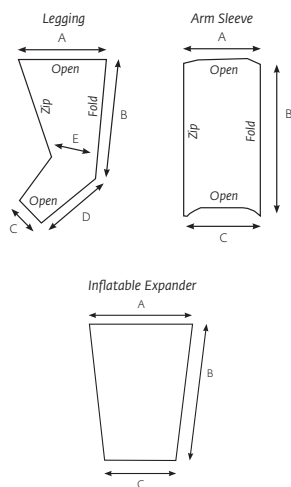

Part No.	A	B	C	D	E
<b>Sequential Garments (Dimensions)</b>					
43034	10"	17"	8"		
43093°	12"	29 ¾"	9"		
43036	9 ¼"	7 ¾"	4 ¾"	5"	7 ¾"
43194°	30"	26"	6"	13"	11 ½"
43092°	30 ½"	32"	6"	13"	10 ½"
43035	11"	29 ¾"	9"		
43149	30"	26"	6"	12"	11"
43032	31 ½"	31 ½"	6"	12"	11"
<b>Inflatable Expanders (Dimensions)</b>					
43127°	4-8-12"	26"	3-6-9"		
43128°	4-8-12"	19 ½"	3-6-9"		
43129°	4-8-12"	32"	3-6-9"		

\* For use with Multi 3 unit only.

## SEQUENTIAL PRESSSION® 3-CHAMBER GARMENTS



For use with Multi 3 unit only



## SEQUENTIAL PRESSSION® 6-CHAMBER GARMENTS



### ORDERING INFORMATION

Part Number	Description
<b>Sequential PresSsion® 3-Chamber Garments</b>	
A 43036	Half Leg, 3 Chambers 20" (51 cm)
B 43194	¾ Leg, 3 Chambers 26" (66 cm)
C 43092	Full Leg, 3 Chambers 32" (81 cm)
D 43034	Half Arm, 3 Chambers 17" (43 cm)
E 43093	Full Arm, 3 Chambers 30" (76 cm)
<b>Sequential PresSsion® 6-Chamber Garments</b>	
A 43032	Full Leg, 6 Chambers 32" (81 cm)
B 43149	¾ Leg, 6 Chambers 26" (66 cm)
C 43035	Full Arm, 6 Chambers 30" (76 cm)
<b>Garment Extenders Full Leg (not shown)</b>	
43167	3" (8 cm) width x 32" (81 cm) Universal Garment
43168	6" (15 cm) width x 32" (81 cm) Universal Garment
<b>D Inflation Expanders For use with Multi 3 unit only</b>	
D 43127	Full Arm or ¾ Leg, 3 Chambers
43128	Half Leg, 3 Chambers
43129	Full Leg, 3 Chambers



**DJO, LLC | A DJO Global Company**  
**T** 800.592.7329   **D** 760.727.1280   **F** 800.936.6569  
1430 Decision Street | Vista, CA 92081-8553 | U.S.A.  
[DJOglobal.com/chattanooga](http://DJOglobal.com/chattanooga)

*Together in Motion™*