

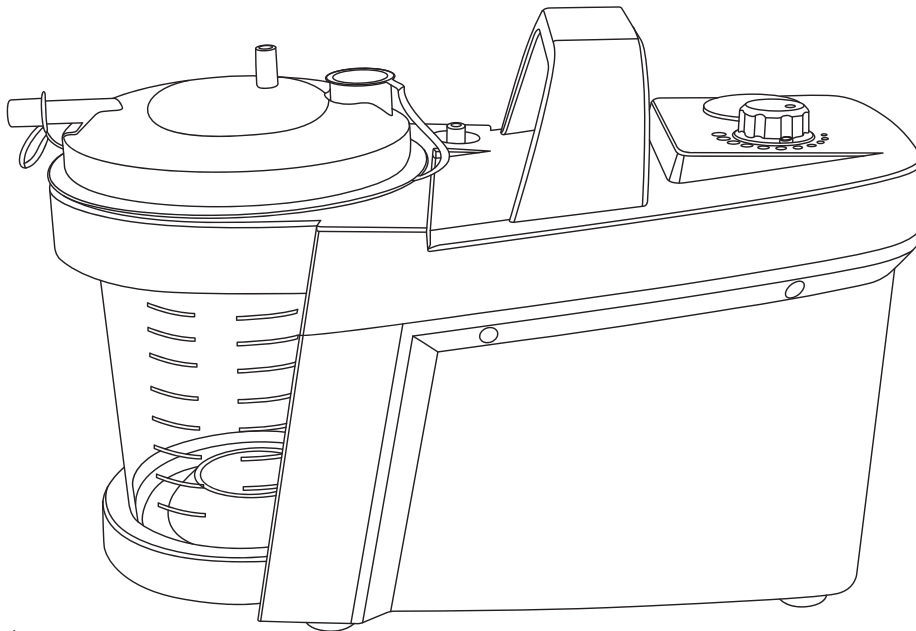

Instruction Manual

Suction Machine AC

SU100AC



Manufactured for
Sunset Healthcare Solutions
180 N Michigan Ave Ste 2000
Chicago, IL 60601
United States

MADE IN CHINA



IP22



This device complies with EU EMC standard EN60601-1-2

Table of Contents

Intended Use	2
Included	2
Important Safeguards	3
Device Specifications	4
Warranty	4
Operating Instructions	5
Cleaning, Sterilization, and Disposal	6
Replaceable Parts and Accessories	7
Legend	7
Electromagnetic Compatibility (EMC) / Recommended Safe Distances ...	8-9

Intended Use

This Electric Suction Unit is intended for the removal of fluids from the airway or respiratory system. This appliance may also be used in the removal of infectious materials from patient wounds.

Utilizing a motor to drive an air pump to generate negative pressure (vacuum), this device will aspirate mucous secretions from the patient’s body, in the management and treatment of respiratory diseases. Aspirated secretions are collected in the canister for proper disposal.

Caution: Federal law restricts this device to sale by or on the order of a physician

Included

- Machine
- AC Adapter and Power Cord
- Carrying Bag
- 800cc Suction Canister
- 3.5in Suction Tube Connector
- 4.5in Suction Tube Connector
- 6ft Suction Tubing
- Bacteria Filter
- Air Filters (6)

Important Safeguards

Note: Read all instructions carefully before use.



Warning: Modification of this equipment voids the Warranty.

No modification of this equipment is allowed.

To avoid strangulation, keep children away from the power cord.

Caution: Failure to read and observe all precautions could result in personal injury or equipment damage.

Product Caution

- To avoid electrical shock, keep the unit away from water; do not immerse the power cord or the unit in any liquid; do not use while bathing; do not reach for a unit that has fallen into water - immediately unplug the unit.
- Never operate the unit if it has any damaged parts (including power cord), and/or if it has been dropped or submersed in water.
- The unit should not be used where flammable gas, oxygen or aerosol spray products are being used.
- Disconnect the unit from the electrical outlet before cleaning, filling and after each use.
- When in operation, ensure the power cable is accessible, but out of the way from accidental disconnection.
- Place the device near an outlet within reach of the patient on a flat and stable surface. Make sure that the ventilation slit on the side of the device is not blocked.

Operating Caution

- Connect this product to an appropriate voltage outlet for your model.
- Do not run this product unattended.
- If any abnormality occurs, discontinue use immediately until the unit has been examined and repaired.

Storage Caution

- Do not store the unit in direct sunlight, extreme temperature or humidity.
- Keep the unit out of reach of children.
- Keep the unit unplugged while storing.

Cleaning Caution

- Clean after each use as instructed in this guidebook.
- Do not immerse the unit in water. It may damage the unit.
- Disconnect the unit from the electrical outlet before cleaning.

Device Specifications

Rated Power Input	AC 100-240V, 50-60Hz, 1.1A / DC 12 V
Power	48VA Max
Max Negative Pressure	530mmHg
Negative Pressure Range	150-530mmHg
Max Suction Speed	25 Lpm
Canister Capacities	800cc, 1,000cc, 1,200cc
Dimensions	13 3/8 x 6 1/4 x 8 3/4 in (340 x 160 x 220 mm)
Weight	4.08 lbs (1.85 kgs)
Operating Environment	50°F to 104°F (10°C to 40°C), 30% to 75% Relative Humidity
Storage Environment	-4°F to 140°F (-20°C to 60°C), 10% to 95% Relative Humidity
Noise	≤ 60 dBA at 1 meter

TWO YEAR LIMITED WARRANTY

This unit is warranted to be free from defective workmanship and materials for a period of two years from the date of purchase. Any defective part will be replaced or repaired at manufacturer's prudence. If proper care and maintenance of this unit is not followed as detailed within the operating manual, the warranty is subject to be terminated. If warranty repair is needed, please contact the place of purchase.

Operating Instructions

Installing the filter

- Open the accessories bags and take out the two connector tubes and the filter.
- Connect one end of the short tube to the air input port and the other end to the filter.
- Connect the filter to the suction canister with the long connector tube.
- Inspect suction tubing and canister for leaks or cracks before each use.

Turn on the device

- Plug in the power cord.
- Turn on the power switch.
- Connect the suction tube to the device, open the suction valve, and make sure airway is unobstructed.
- Adjust the negative pressure using the knob; choose the appropriate negative pressure for the appropriate physician-recommended treatment of the patient.

Turn off the device

- After the treatment is over, turn off the power switch.
- The working cycle of the device is 30 minutes on and 30 minutes off.

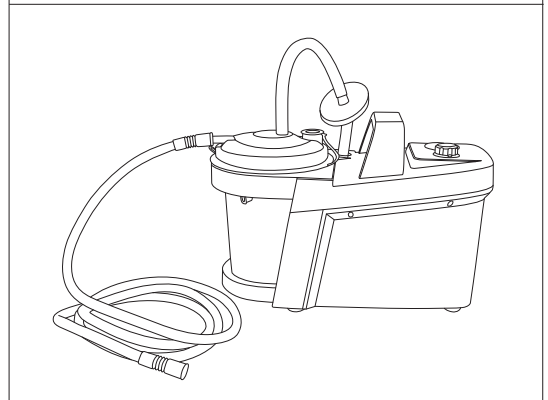
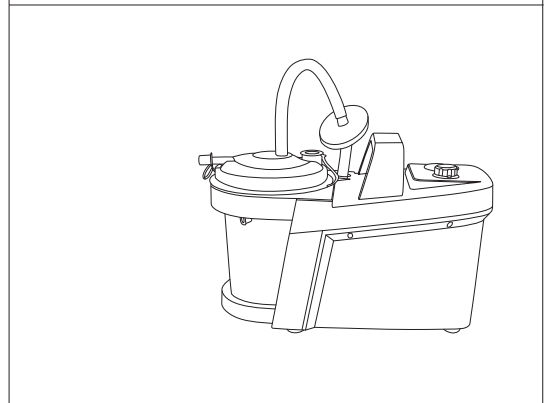
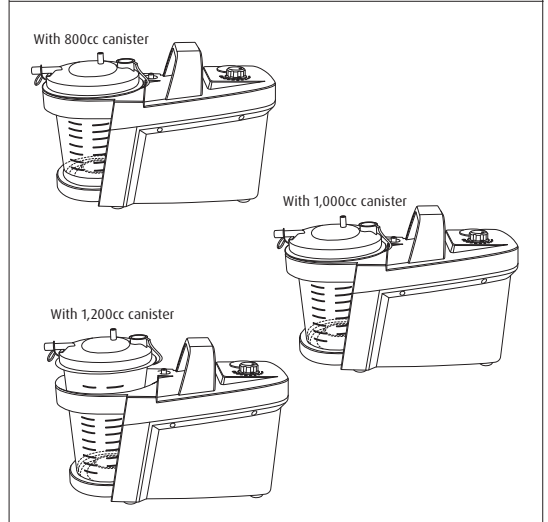
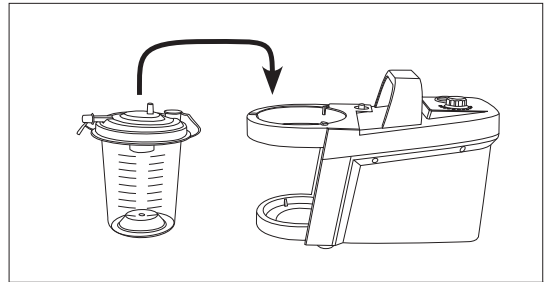

Cleaning, Sterilization, and Disposal



Disconnect from power source prior to cleaning

- It is recommended that the tubing and canister be thoroughly cleaned with hot water after each use and be cleaned with a mild detergent after the last treatment of the day. If your physician or respiratory therapist specifies a different cleaning procedure, follow their instructions.
- The filter cannot be cleaned.
- If the filter gets wet, or becomes contaminated or clogged, it must be replaced.

Rinsing (after each treatment)

- Disconnect the tubes, canister and the filter cover. Rinse the tubes and canister with water.
- Dry them with a clean, soft towel or let air dry.
- Reassemble the product when completely dry and put in a clean, sealed container.

Disinfection

Please abide by the following steps to disinfect your suction device unless otherwise specified by a physician. It is suggested that the unit is disinfected after each treatment.

- Using one part white vinegar with three parts distilled water, make a bath to submerge the tubes and canister.
- Disconnect the tubes and canister from the machine and filter. Wash the tubes and canister in warm water and mild detergent. Then wash them in hot tap water.
- Submerge the tubes and canister in the vinegar and water solution bath for 30 minutes.
- Dry tubes and canister with clean soft towel or let air dry.
- Reassemble the product when completely dry and put in a clean, sealed container.

Changing the air filter

Open the small circular hatch on the bottom of the unit counter-clockwise. Replace the BF018 foam air filter if it appears to be dirty, or after 3 months of use.



Danger of infection

The device and accessories may come into contact with infectious material and be contaminated during their lifetime. For this reason, the device and its accessories should be decontaminated before disposal or transportation.

Dispose of the device properly at the end of its service life. According to the European Directives 2002/96 / EC (WEEE) and 2002/95 / EC (RoHS) the device may not be disposed of with unsorted domestic waste. Carefully separate materials. Consider local and country-specific laws and regulations that apply to the disposal of the device. The proper disposal prevents environmental damage and human harm.

Commercial bacterial germicides specifically intended for cleaning medical devices within the institutional environment may be used to clean this equipment, in compliance with the germicide manufacturer's recommended instructions.

Replaceable Parts and Accessories

Always use Sunset Healthcare Solutions parts:

3.5in Connector Tube RES024

4.5in Connector Tube RES024M

6ft Suction Tubing RES025 or FDA or CE approved 1/4in or 6mm ID / 9mm OD suction tubing

Bacteria Filter BF1438

Canister 800cc RES023AW

AC Adapter without Cord SU100DC-Adapt





























Power Cord without Adapter SU100DC-Cord

Sunset Suction Kit RES026S-SS (Includes 800cc Canister, 3.5in Tube, 4.5in Tube, Bacteria Filter, 6ft Tube)

Sunset Component Kit RES024-MKIT (Includes 3.5in Tube, 4.5in Tube, Bacteria Filter)

Air Filter BF018

Legend

	Consider instructions for use		Not for reuse
	Manufacturer		Order number
	Date of manufacture		Batch number
	Use by		Serial number
	Latex free		Attention
	Contains phthalate		Store away from sunlight
	Type BF		Temperature Limit
	Protection class II		Relative humidity, limit
	Do not use when packaging is damaged		Protection against contact with fingers and medium-sized solid bodies, protection against dripping water.
	Sterilized with ethylene oxide		Direct Voltage
	Vacuum connection		Patient tube connection
	On (Power)		Quantity
	OFF (Power)		Length
	Adjusting direction to increase (+) and decrease (-) the vacuum		
Asp. MAX	Maximum Vacuum		
High Vacuum / High Flow	High Vacuum / High Flow		The device and its components may not be disposed of with normal commercial or household waste (batteries in particular).

Electromagnetic Compatibility (EMC) / Recommended Safe Distances

Medical equipment needs special precautions regarding electromagnetic compatibility (EMC). The device needs to be installed and put into service according to the EMC information provided in this chapter.

Portable and Mobile RF Communications Equipment can effect Medical Electrical Equipment. Use this table as a guide to help prevent electromagnetic interference by maintaining a minimum distance between mobile RF Communications Equipment (transmitters) and the suction unit.

Guideline and declaration by the manufacturer - electromagnetic emissions - for all devices and systems!			
The device is constructed in such a way that it can also be used in a specific electromagnetic field. The user must ensure that this product is used under the following conditions.			
Emissionstest	Compliance	Electromagnetic Environment - Guidelines	
RF-Emission CISPR 11	Group 1	The device uses RF energy for its internal functions. For this reason, the probability that the electrical devices in the vicinity are disrupted by the RF emissions is very low.	
RF-Emission CISPR 11	Class B Radiated and Conducted Emissions	This device is suitable for use in all establishments including domestic, and those directly connected to the public low-voltage power supply network that supplies buildings used for domestic purposes.	
Harmonic emissions IEC 61000-3-2	Class A		
Voltage fluctuations/ flicker emissions IEC 61000-3-3	Complies		
Immunity Test	IEC 60601 Test Level	Compliance Level	Electromagnetic Environment - Guidelines
Discharge of static electricity (ESD) IEC 61000-4-2	+/- 6kV Contact +/- 8kV Air	+/- 6kV Contact +/- 8kV Air	The substrate should be made of wood, concrete or ceramic tiles. If the floor is covered with synthetic material, the relative humidity must be at least 30%.
Electrical Fast Transient/ burst IEC 61000-4-4	±2kV on AC Mains	±2kV on AC Mains	Mains power quality should be that of a typical commercial or hospital environment.
Surge IEC 61000-4-5	±1kV Differential ±2kV Common	±1kV Differential ±2kV Common	
Voltage dips, short interruptions and voltage variations on power supply input lines IEC 61000-4-11	>95% Dip for 0.5 Cycle 60% Dip for 5 Cycles 30% Dip for 25 Cycles >95% Dip for 5 Seconds	>95% Dip for 0.5 Cycle 60% Dip for 5 Cycles 30% Dip for 25 Cycles >95% Dip for 5 Seconds	Mains power quality should be that of a typical commercial or hospital environment. If the user of this device requires continued operation during power mains interruptions, it is recommended that the device be powered from an uninterruptible power supply or battery.

Immunity Test	IEC 60601 Test Level	Compliance Level	Electromagnetic Environment - Guidelines
Magnetic fields with energy frequencies (50/60 Hz) IEC 61000-4-8	3A/m	3A/m	Magnetic fields with energy frequencies should be located at a level typical for normal commercial or hospital environments.
Conducted RF IEC 61000-4-6	3 Vrms from 150 kHz to 80 MHz	V1 = 3 Vrms	Portable and mobile RF communications equipment should be separated from the device by no less than the recommended separation distances calculated/listed below: $D=(3.5/V1)\sqrt{P}$
Radiated RF IEC 61000-4-3	3 V/m 80 MHz to 2.5 GHz	E1 = 3V/m	$D=(3.5/E1)\sqrt{P}$ 80 to 800 MHz $D=(7/E1)\sqrt{P}$ 800 MHz to 2.5 GHz Where P is the maximum starting capacity of the transmitter in watts (W) and d is the recommended distance in metres (m) pursuant to the transmitter manufacturer information. The field strength of the fixed RF transmitter, which is determined by an electromagnetic site appraisal a, must fall under the compliance level in each frequency range. Disruptions may occur near devices, which are characterized by the following: 

For transmitters rated at a maximum output power not listed above, the recommended separation distance D in meters (m) can be estimated using the equation applicable to the frequency of the transmitter, where P is the maximum output power rating of the transmitter in watts (W) according to the transmitter manufacturer.

Note 1: At 80 MHz and 800 MHz, the separation distance for the higher frequency range applies.

Note 2: These guidelines may not apply in all situations. Electromagnetic propagation is affected by absorption and reflection from structures, objects, and people.

Recommended distances between portable and mobile RF communication equipment and the suction pump. This device and system are not Life-Supporting.

The suction pump is intended for use in the electromagnetic environment in which radiated disturbances are controlled. The customer or user of this device can help prevent electromagnetic interference by maintaining a minimum distance between portable and mobile RF Communications Equipment and the device as recommended below, according to the maximum output power of the communications equipment.

Maximum power output of the transmitter (W)	Distance pursuant to transmitter frequency (m)		
	150 kHz to 80 MHz $D=(1.1667)\sqrt{P}$	80 MHz to 800 MHz $D=(1.1667)\sqrt{P}$	800 MHz to 2,5 GHz $D=(2.3333)\sqrt{P}$
0.01	0.11667	0.11667	0.23333
0.1	0.36894	0.36894	0.73785
1	1.1667	1.1667	2.3333
10	3.6894	3.6894	7.3785
100	11.667	11.667	23.333

For transmitters rated at a maximum output power not listed above, the recommended separation distance D in meters (m) can be estimated using the equation applicable to the frequency of the transmitter, where P is the maximum output power rating of the transmitter in watts (W) according to the transmitter manufacturer.

Note 1: At 80 MHz and 800 MHz, the separation distance for the higher frequency range applies.

Note 2: These guidelines may not apply in all situations. Electromagnetic propagation is affected by absorption and reflection from structures, objects, and people.

