



icon
Digital Clinical Scale
Owner's Manual



INTRODUCTION

Thank you for purchasing our Detecto icon® Digital Clinical Scale. It has been manufactured with quality and reliability and has been tested before leaving our factory to insure accuracy and dependability for years to come.

This manual is provided to guide you through installation and operation of your scale. Please read it thoroughly before attempting to install or operate your scale and keep it handy for future reference.

This manual is for all icon model configurations

ICON	ICON-ACUK
ICON-WI	ICON-WI-ACUK
ICON-UWA	ICON-UWA-ACUK
ICON-LXI	ICON-LXI-ACUK

COPYRIGHT

All rights reserved. Reproduction or use, without expressed written permission, of editorial or pictorial content, in any manner, is prohibited. No patent liability is assumed with respect to the use of the information contained herein.

DISCLAIMER

While every precaution has been taken in the preparation of this manual, the Seller assumes no responsibility for errors or omissions. Neither is any liability assumed for damages resulting from use of the information contained herein. All instructions and diagrams have been checked for accuracy and ease of application; however, success and safety in working with tools depend to a great extent upon the individual accuracy, skill and caution. For this reason the Seller is not able to guarantee the result of any procedure contained herein. Nor can they assume responsibility for any damage to property or injury to persons occasioned from the procedures. Persons engaging the procedures do so entirely at their own risk.



FCC COMPLIANCE STATEMENT

This equipment generates, uses and can radiate radio frequency and if not installed and used in accordance with the instruction manual, may cause interference to radio communications. It has been designed within the limits for a Class A computing device pursuant to Subpart J of Part 15 of FCC rules to provide reasonable protection against such interference when operated in a commercial environment. Operation of this equipment in a residential area may cause interference in which case the user will be responsible to take whatever measures necessary to correct the interference.

You may find the booklet "How to Identify and Resolve Radio TV Interference Problems" prepared by the Federal Communications Commission helpful. It is available from the U.S. Government Printing Office, Washington, D.C. 20402. Request stock No. 001-000-00315-4.

Serial Number _____
Date of Purchase _____
Purchased From _____

RETAIN THIS INFORMATION FOR FUTURE USE

<h2>PRECAUTIONS</h2> <p>Before using this scale, read this manual and pay special attention to all "NOTIFICATION" symbols:</p>  <p>IMPORTANT</p>  <p>ELECTRICAL WARNING</p>

PROPER DISPOSAL

When this device reaches the end of its useful life, it must be properly disposed of. It must not be disposed of as unsorted municipal waste. Within the European Union, this device should be returned to the distributor from where it was purchased for proper disposal. This is in accordance with EU Directive 2002/96/EC. Within North America, the device should be disposed of in accordance with the local laws regarding the disposal of waste electrical and electronic equipment.

It is everyone's responsibility to help maintain the environment and to reduce the effects of hazardous substances contained in electrical and electronic equipment on human health. Please do your part by making certain that this device is properly disposed of. The symbol shown to the right indicates that this device must not be disposed of in unsorted municipal waste programs.



CAUTION



CAUTION: RISK OF EXPLOSION IF BATTERY IS REPLACED BY AN INCORRECT TYPE. DISPOSE OF USED BATTERIES ACCORDING TO THE INSTRUCTIONS.

ATTENTION: RISQUE D'EXPLOSION SI LA BATTERIES EST REMPLACÉ'E PAR UN TYPE INCORRECT. REJETEZ LES BATTERIES UTILISÉ'ES SELON LES INSTRUCTIONS.

TRANSPORTATION AND STORAGE



Do Not Drop

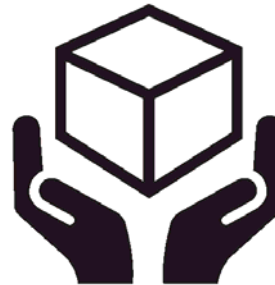

Handle With Care



Keep Dry

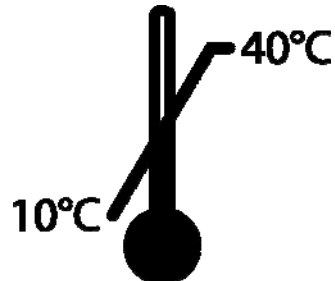

Temperature Range

TABLE OF CONTENTS

SPECIFICATIONS	Page 1
Standard Features	Page 1
Optional Features	Page 1
SITE PREPARATION REQUIREMENTS	Page 3
UNPACKING	Page 4
ASSEMBLY	Page 4
PLACING THE SCALE	Page 6
INTERCONNECTIONS	Page 6
AC Power Adapter	Page 6
USB	Page 6
Height Rod – Detecto Sonar Height Rod	Page 6
Batteries	Page 6
Battery Status	Page 7
Battery Installation/Replacement	Page 7
UNITS SELECTION	Page 8
KEYPAD FUNCTIONS	Page 9
ANNUNCIATORS	Page 11
OPERATION	Page 12
Zero Weight Display	Page 12
Basic Operation	Page 12
Basic Operation with ID – (No BMI)	Page 12
Body Mass Index (BMI) Operation – (No ID)	Page 13
Body Mass Index (BMI) Operation with ID	Page 13
Body Mass Index (BMI) Operation, Manually Entering Known Height	Page 14
Body Mass Index (BMI) Operation with ID, Manually Entering Known Height ...	Page 14
SCALE SETUP	Page 15
SCALE CALIBRATION	Page 21
ERROR AND OPERATION MESSAGES	Page 23
BEFORE YOU CALL SERVICE	Page 24
CARE AND CLEANING	Page 25
PARTS IDENTIFICATION	Page 26
STATEMENT OF LIMITED WARRANTY	Page 32

SPECIFICATIONS

Capacity:	600 lb x 0.2 lb / 1,000 lb x 0.5 lb 300 kg x 0.1 kg / 500 kg x 0.2 kg
Weighing/Height Units:	Pounds/Inch (lb, in) or Kilograms/Centimeters (kg, cm)
Platform Size:	17 in W x 17 in D x 1.5 in H (43 cm W x 43 cm D x 3.8 cm D)
Overall Dimensions:	17 in W x 18.5 in D x 88.5 in H (43 cm W x 47 cm D x 224.8 cm H)
Sonar Height Rod Measures:	24" (2') – 86" (7'2") x 0.2 in (60 cm – 218 cm) x 0.5 cm
Display Type:	3.2 in (diagonal) full color TFT display 320x240 resolution
Number of Characters:	Weight: 5 digit, 0.8 in (20 mm) high Height: 4 digit, 0.35 in (9 mm) high BMI: 3 digit, 0.35 in (9 mm) high
Touch Screen:	Resistive touch panel covering the display
Keys:	Mechanical switch type, Power, Zero, Lock/Release, ID, Cycle Display Mode, Menu, Print
Power Requirements:	Included 100 to 240 VAC 50/60Hz 12 VDC 1A wall plug-in UL/CSA listed AC power adapter (Cardinal part number 6800-1045) or optional 12 "AA" cell Alkaline, Ni-Cad or NiMH batteries (<i>not included</i>)
Operating Environment:	Operated Temperature Range: 14 to 104 °F (-10 to +40 °C) Humidity: 0 to 90% non-condensing
Communication Interfaces:	RS232, USB

Standard Features:

- Dual Range Weight
- Auto Weight Lock Feature
- StableSENSE®¹ Adjustable Filtering
- 8-Digit Numeric Patient ID
- 1 RS232 Serial Port
- 1 USB-B Port
- Sonar Height Rod

Optional Features:

- Wi-Fi
- Bluetooth
- WACONNECT, Welch Allyn® Interface

¹ StableSENSE® is a digital filter utilizing proprietary software algorithms to remove or greatly reduce changes in the weight display resulting from movement on the scale platform. StableSENSE® can be used with clinical scales to lessen the effects of the patient's movement or vibration on the scale. Any application affected by vibration or movement on the scale platform can benefit using StableSENSE®.

This page intentionally left blank.

SITE PREPARATION REQUIREMENTS

The icon Digital Clinical Scale is a precision weight indicating instrument. As with any precision instrument, it requires an acceptable environment to operate at peak performance and reliability. This section is provided to assist you in obtaining such an environment.

Environmental

- For indoor use only.
- Suitable for dry environments only RH < 90% and non-condensing environments.
- NEVER allow scale to get wet.
- The scale meets or exceeds all certification requirements within a temperature range of 14 to 104 °F (-10 to +40 °C).

The scale should be placed out of direct sunlight and to provide adequate air circulation, keep the area around the scale clear.

Do not place the scale directly in front of a heating or cooling vent. Such a location will subject it to sudden temperature changes, which may result in unstable weight readings.

Insure that the scale has good, clean AC power and is properly grounded. In areas subject to lightning strikes, additional protection to minimize lightning damage, such as surge suppressors, should be installed.

Electrical Power

The icon Digital Clinical Scale has been designed to operate from a 100 to 240 VAC 50/60Hz 12 VDC 1A wall plug-in UL/CSA listed AC power adapter. Note that a special order is not required for operation at 230 VAC.

- The socket-outlet supplying power to the scale should be near the scale and should be easily accessible.
- On installations requiring 230 VAC power, **it is the responsibility of the customer** to have a qualified electrician install the proper power adapter plug that conforms to national electrical codes and local codes and ordinances.

Electrical Noise Interference

To prevent electrical noise interference, make certain all air conditioning and heating equipment, lighting or other equipment with heavily inductive loads, such as welders, motors and solenoids are on circuits separate from the system. Many of these disturbances can seriously affect the operation of the system. These sources of disturbances must be identified and steps must be taken to prevent possible adverse effects on the system. Examples of available alternatives include isolation transformers, power regulators, uninterruptible power supplies, or simple line filters.

UNPACKING

Carefully remove the icon Digital Clinical Scale from the shipping carton and inspect it for any damage that may have taken place during shipment. *Keep and use the original carton and packing material for return shipment if it should become necessary.* The purchaser is responsible for filing all claims for any damages or loss incurred during transit. Remove all plastic wrapping, foam fillers and cardboard material from scale platform, display and other components. You should have the following components:

- ① Column with attached Display and Sonar Bracket
- ② Column Cover
- ③ Scale Base
- ④ Scale Base Cover
- ⑤ Sonar Height Rod
- ⑥ AC Power Adapter

ASSEMBLY

TOOLS REQUIRED:

- 3/16" Allen wrench
- #2 Phillips Screwdriver

1. Place the scale base on a level floor.
2. Insert the column cover onto the column.
3. Position the column over the opening in the scale base and then plug the modular connector from the column into the socket in the scale base.
4. Insert the column into the scale base.
5. Using the 3/16" Allen wrench, *evenly* tighten the (4) Allen head screws on the back of the scale base to secure column to scale base.



NOTE: The nuts on the front of the column opening in the scale base may turn as you are tightening the Allen head screws.

This is normal. DO NOT use a wrench or other tool to hold the nut to keep it from turning!

6. Slide the column cover down onto the base. Note that you may have to pull the cover out slightly to clear the AC power jack.
7. Remove (6) screws securing sonar bracket to column and set bracket aside.
8. Align wire connector from the end of Sonar tube with the wire connector from the back of column and plug together.
9. Insert the connector into the hole on back of column.
10. Place the sonar tube on back of the column and hold in place.
11. Place the bracket over the sonar tube and align the holes in the bracket with the holes in the column.

IMPORTANT! Make sure the bend of the sonar tube is against the back throat of the column.

12. Insert the screws removed earlier and using the #2 Phillips screwdriver, tighten the screws to secure the sonar bracket to the column.
13. Place the scale base cover on the scale base and press down on both sides of the cover. Note that a clicking sound will occur when the cover is snapped in place.
14. Scale is now ready for operation.



NOTE: For instructions on powering the scale using the AC power adapter or for instructions on how to install batteries, refer to the INTERCONNECTIONS section of this manual.



Step 1



Step 2

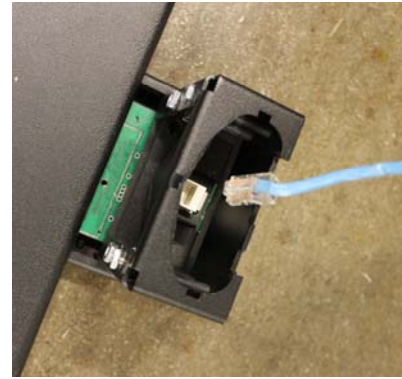

Step 3



Step 4

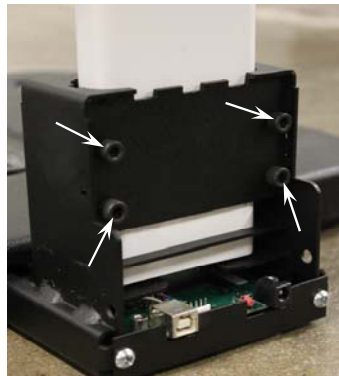

Step 5

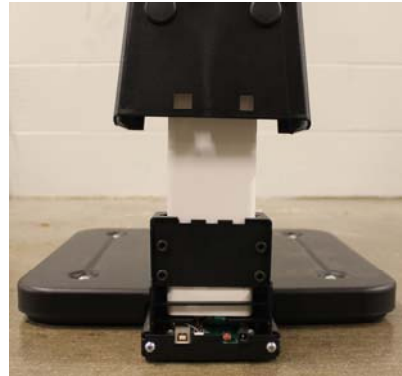

Step 6



Step 7



Step 8



Step 9



Step 10



Step 11



Step 12

PLACING THE SCALE

- For indoor use only.
- Place scale on a flat, level floor or low-cut carpet away from heating and cooling vents.
- Make certain the AC Power Adapter cord is out of the way of normal traffic to avoid a trip hazard.
- NEVER allow scale to get wet.

Check to make certain the scale is level. The level indicator is located at the rear of the scale. If the scale is not level (the bubble will not be centered), position the scale as required to center the bubble and attain a level scale.

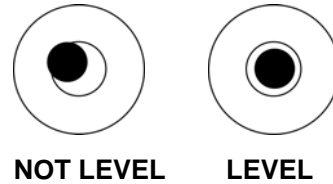

NOTE: Any time the scale is moved or re-located, be sure to check the level bubble to ensure the scale is level before using.

INTERCONNECTIONS

The output and power connections to the scale are made on the rear of the scale base.

AC Power Adapter

To power the scale using the 12VDC wall plug-in UL/CSA listed AC power adapter, connect the plug from the adapter into the power jack on the back of the scale base and then plug the power adapter into the proper electrical outlet. On models requiring 230 VAC, it is the customer's responsibility to obtain the correct power adapter plug.

USB

The USB port on the scale is a device (or upstream) port and uses readily available cables with the industry standard "Micro-B" connector.

The USB port may be connected to a computer for transmission of weight and associated data to a PC-based EMR (electronic medical record) software program. The data can be transmitted on demand (pressing the ← key) or on receipt of a command from the computer.

Height Rod – Detecto Sonar Height Rod

The Detecto Sonar Height Rod connects to the scale by a snap-in modular connector socket. Insert the modular connector of the Sonar Height Rod into the socket on the back of the scale column it locks in place (a clicking sound will be heard when it is locked in place).

Batteries

The scale can use 12 "AA" size Alkaline, Ni-Cad or NiMH batteries (*not included*). You must first obtain and install batteries before operations can begin. Batteries are contained in two (2) battery holders inside the scale base. Access is via two (2) removable panels in the scale base, accessible after removing the scale platform cover.



CAUTION! The scale can be operated from Alkaline, Ni-Cad or NiMH batteries. All twelve (12) batteries must be of the same type. They must all be Alkaline, all Ni-Cad or all NiMH. **DO NOT** mix Alkaline and Ni-Cad or NiMH batteries.



NOTE: The icon scale does not have a battery charging circuit. Should you wish to use Ni-Cad or NiMH batteries, they must be fully charged before installing. When discharged, Ni-Cad or NiMH batteries must be removed and placed in an external charger to recharge.

Battery Status

The battery status will be displayed when batteries are installed. A number will be displayed in the upper right of the screen indicating the level of charge remaining in the batteries. For example 100 = 100% charge, 75 = 75% charge, etc.

When the batteries are the point they need to be replaced (Alkaline) or recharged (NiCad or NiMH) and the battery voltage drops too low for accurate weighing, the scale will automatically shut off and you will be unable to turn it back on.

Using Alkaline Batteries

When the batteries are low enough that the scale turns off, remove the old batteries and replace with new ones.

Using NiCad or NiMH Batteries

When the batteries are low enough that the scale turns off, remove the discharged batteries and replace with fully charged ones. Place the discharged batteries in an external charger to recharge.

Battery Installation/Replacement

To install or remove the batteries, the following steps should be followed:

1. Make sure the AC power adapter is unplugged.
2. Remove the platform cover from the scale base.
3. Referring to Figure No. 1, locate the two (2) rectangular panels in the scale base.
4. To install or replace the batteries, first remove each battery holder cover by pushing in on the tab and lifting it up exposing the battery holders. See Figure No. 2 and 3.
5. If installing new batteries, proceed to step 6. If replacing the batteries, remove all 6 batteries from the battery holder and then proceed to step 6.
6. Referring to Figure No. 4, install six (6) "AA" size batteries in the each holder, noting the polarity markings located in the battery holder.
7. After placing all six (6) batteries in each holder, replace the battery covers.



Figure No. 1

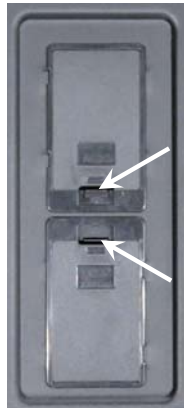



Figure No. 2



Figure No. 3



Figure No. 4

8. Install the platform cover on the scale base and press the  key.
9. If display turns on, batteries have been installed correctly. If not, remove the platform cover and then the battery covers and check for one or more improperly positioned batteries.
10. The scale is now ready for operation.

UNITS SELECTION

When the scale is powered on for the first time, the display will prompt for which weighing and height units to use, LB/IN or KG/CM.

1. Press  key to turn the scale on.
2. The scale display will show the software version for a few seconds, the Detecto logo briefly and then change to the Select Units screen.

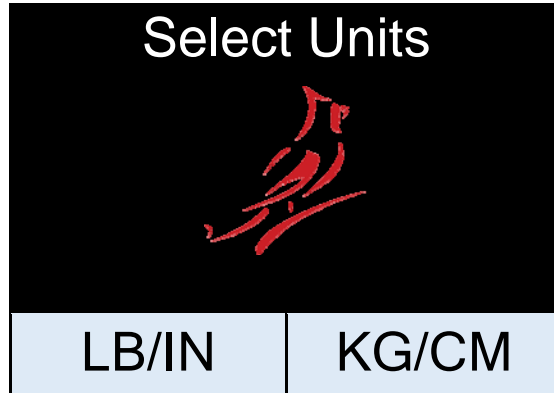

3. Press the LB/IN key at the bottom left of the screen to select pounds for weighing units and inches for height measurement.
4. Press the KG/CM key on the bottom right of the screen to select kilograms for weighing units and centimeters for height measurement.
5. The scale is now ready for operation.
6. Once the units setting is selected, it will be kept.



NOTE: If it is desired to change the units setting, refer to the **SCALE SETUP** section, **Setup Menu Page 1, Units: selection.**

KEYPAD FUNCTIONS



DO NOT operate the keys or touchscreen with pointed objects (pencils, pens, etc.). Damage to keys or touchscreen resulting from this practice is **NOT** covered under warranty.



This is the **Power** key. With the scale off, pressing this key will apply power to it and turn on the display. If the scale is already on, pressing the key will turn it off.



This is the **Zero** key. Press and release this key to reset the display to zero, up to 100% of the scale capacity.



This is the **Lock/Release** key. Press and release this key, or touch the weight readout on the display to cause the weight, height, and BMI to lock on the current values until the key is pressed again or the weight readout on the display is touched again. While the weight is locked, the weight status will change to LOCKED in order to denote that the weight is being held.



This is the **ID** key. Press and release this key to open the ID entry screen where you can use the touch screen to enter in a numeric ID. This ID is **NOT** used for tracking patient measurements. The ID that is entered is only transmitted out of the communication port when the ↩ key is pressed. To change or edit the ID, simply press the **ID** key again to return to the ID entry screen.



This is the **Display Mode** key. Press and release this key to cause the display to cycle between display modes: Weight/Height/BMI or Weight only.



This is the **Menu** key. Press and release this key to launch the Menu screen. The first screen that is displayed is the Setup Review screen where you can see all of the settings at a glance. To continue into setup, touch the Setup key at the bottom right of the touch screen.



This is the **Enter** key. Press and release this key to signal completion of the entry of data and cause the scale to output the current weight, height, and BMI for data capture for EMR/EHR purposes. The options include Cardinal SMA, Welch Allyn, Tanita, or IEEE 11073-10415 formats.

ANNUNCIATORS

The annunciators are displayed on the Weight screen to show that the scale is in the mode corresponding to the annunciator label or that the status indicated by the label is active.

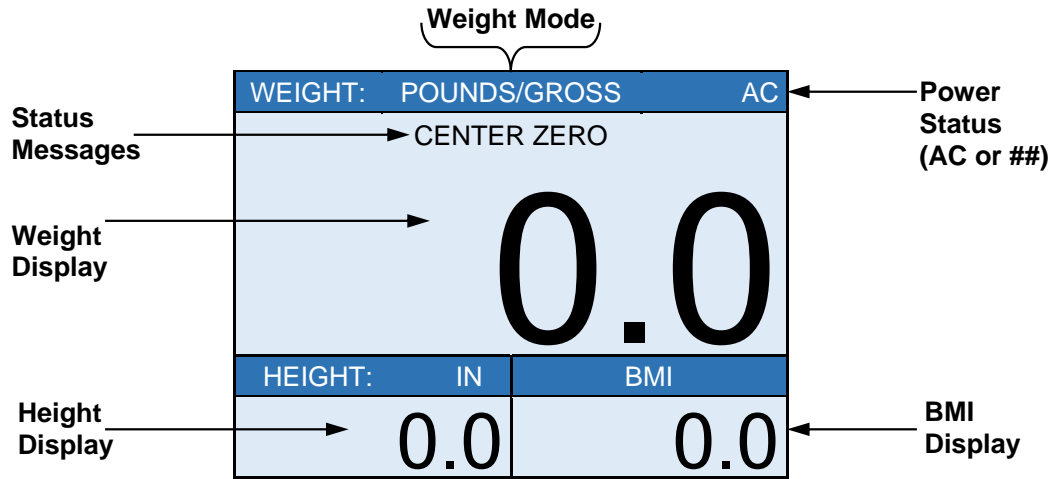

AC

This is shown on the Weight screen to indicate that the scale is powered by the AC adapter.

##

This is shown on the Weight screen to indicate that the scale is powered by batteries and the percentage of their remaining charge.

POUNDS/GROSS

This is shown on the Weight screen to indicate that the weight displayed is gross weight in pounds.



KILOGRAMS/GROSS

This is shown on the Weight screen to indicate that the weight displayed is gross weight in kilograms.

CENTER ZERO

This is shown on the Weight screen to indicate that the weight is within +/- 1/4 division of the center of zero.

LOCK

This is shown on the Weight screen to indicate that the scale is locked onto the displayed weight. In operation after obtaining a stable weight value, pressing the  key will cause the scale to lock onto the weight and turn on the annunciator. Pressing the  key a second time will unlock the display and turn off the annunciator.

IN

This is shown on the Weight screen to indicate that the displayed height measurement is in inches.

CM

This is shown on the Weight screen to indicate that the displayed height measurement is in centimeters.

BMI

This is shown on the Weight screen to indicate the calculated body fat (Body Mass Index).

OPERATION



ALWAYS assist the patient in stepping on and off the scale platform to ensure they do not fall. **NEVER** leave a patient unattended while they are on the scale platform. Failure to maintain control of the patient at all times can result in serious injury to you and/or the patient.

Zero Weight Display

1. In Gross Weight mode (POUNDS/GROSS or KILOGRAMS/GROSS shown on weight screen), if scale is not showing zero weight on weight screen press ⇨0⇩ key.
2. Weight screen will return to zero (0.0) and CENTER ZERO will be displayed to show that the scale is ready for use.

Basic Operation

To Weigh

1. Press ⏻ key to turn scale on.
2. If required, press ⇨0⇩ key to zero weight screen.
3. Assist patient on scale
4. When weight is stable, a beep will sound, weight reading will automatically lock and AUTO LOCK will be displayed. Note that the amount of time the reading will hold is dependent upon the Auto Locking setting in Setup. **NOTE:** If more time is needed, press the 🔒 key to hold the locked weight reading.
5. Read weight display.
6. If desired, press the ↵ key to output EMR/EHR data.
7. Assist patient off scale.

Basic Operation with ID – (No BMI)

To Weigh



1. Press ⏻ key to turn scale on.
2. If required, press ⇨0⇩ key to zero weight screen.
3. Press 👤 key.
4. Display will change to show PATIENT ID screen.
5. Using numeric keys, enter up to an 8 digit numeric identification number.
6. Press **Save** key.
7. Assist patient on scale
8. When weight is stable, a beep will sound, weight reading will automatically lock and AUTO LOCK will be displayed. Note that the amount of time the reading will hold is dependent upon the Auto Locking setting in Setup. **NOTE:** If more time is needed, press the 🔒 key to hold the locked weight reading.
9. Read weight display.
10. If desired, press the ↵ key to output EMR/EHR data.
11. Assist patient off scale.

Body Mass Index (BMI) Operation – (No ID)

To Weight, Measure Height and Calculate BMI



1. Press  key to turn scale on.
2. If required, press $\Rightarrow 0 \Leftarrow$ key to zero weight screen.
3. Assist patient onto scale.

NOTE: In order to obtain an accurate height measurement, instruct patient to look straight ahead and not down at scale display.



4. When weight is stable, a beep will sound, weight reading will automatically lock and AUTO LOCK will be displayed. Note that the amount of time the reading will hold is dependent upon the Auto Locking setting in Setup. **NOTE:** If more time is needed, press the  key to hold the locked weight reading.
5. Scale will have completed measuring patient's height and calculating their BMI.
6. Read weight, height and BMI displayed.
7. If desired, press the  key to output EMR/EHR data.
8. Assist patient off scale.

Body Mass Index (BMI) Operation with ID

To Weight, Measure Height and Calculate BMI



1. Press  key to turn scale on.
2. If required, press $\Rightarrow 0 \Leftarrow$ key to zero weight screen.
3. Press  key.
4. Display will change to show PATIENT ID screen.
5. Using numeric keys, enter up to an 8 digit numeric identification number.
6. Press **Save** key.
7. Assist patient onto scale.

NOTE: In order to obtain an accurate height measurement, instruct patient to look straight ahead and not down at scale display.

8. When weight is stable, a beep will sound, weight reading will automatically lock and AUTO LOCK will be displayed. Note that the amount of time the reading will hold is dependent upon the Auto Locking setting in Setup. **NOTE:** If more time is needed, press the  key to hold the locked weight reading.
9. Scale will have completed measuring patient's height and calculating their BMI.
10. Read weight, height and BMI displayed.
11. If desired, press the  key to output EMR/EHR data.
12. Assist patient off scale.





Body Mass Index (BMI) Operation

Manually Entering Known Height

1. Press  key to turn scale on.
2. If required, press $\Rightarrow 0 \Leftarrow$ key to zero weight screen.
3. Press **HEIGHT** on display screen.
4. If POUNDS/INCHES was selected for **Units:** in setup, display will change to show HEIGHT IN INCHES on screen.
 - a. Use numeric keys to enter up to 3 digits and decimal point (#.#) for height in inches and then press **Save** key.
5. If KILOGRAMS/CENTIMETERS was selected for **Units:** in setup, display will change to show HEIGHT IN CENTIMETERS on screen.
 - a. Use numeric keys to enter up to 2 digits and decimal point (#.#) for height in centimeters and then press **Save** key.
6. Assist patient onto scale.
7. When weight is stable, a beep will sound, weight reading will automatically lock and AUTO LOCK will be displayed. Note that the amount of time the reading will hold is dependent upon the Auto Locking setting in Setup. **NOTE:** If more time is needed, press the  key to hold the locked weight reading.
8. Scale will have completed calculating patient's BMI.
9. Read weight and BMI displayed.
10. If desired, press the  key to output EMR/EHR data.
11. Assist patient off scale.

Body Mass Index (BMI) Operation with ID

Manually Entering Known Height

1. Press  key to turn scale on.
2. If required, press $\Rightarrow 0 \Leftarrow$ key to zero weight screen.
3. Press  key.
4. Display will change to show PATIENT ID screen.
5. Using numeric keys, enter up to an 8 digit numeric identification number.
6. Press **Save** key.
7. Press **HEIGHT** on display screen.
8. If POUNDS/INCHES was selected for **Units:** in setup, display will change to show HEIGHT IN INCHES on screen.
 - a. Use numeric keys to enter up to 3 digits and decimal point (#.#) for height in inches and then press **Save** key.
9. If KILOGRAMS/CENTIMETERS was selected for **Units:** in setup, display will change to show HEIGHT IN CENTIMETERS on screen.
 - a. Use numeric keys to enter up to 2 digits and the decimal point (#.#) for height in centimeters and then press **Save** key.
10. Assist patient onto scale.
11. When weight is stable, a beep will sound, weight reading will automatically lock and AUTO LOCK will be displayed. Note that the amount of time the reading will hold is dependent upon the Auto Locking setting in Setup. **NOTE:** If more time is needed, press the  key to hold the locked weight reading.
12. Scale will have completed calculating patient's BMI.
13. Read weight and BMI displayed.
14. If desired, press the  key to output EMR/EHR data.
15. Assist patient off scale.

SCALE SETUP

Your icon Digital Clinical Scale has been pre-configured at the factory and should not require changes for use in most applications. However, if the factory settings do not meet the requirements of your operation, the following describes the setup process for your scale.



NOTE: The keypad and touchscreen are not to be operated with pointed objects (pencils, pens, fingernails, etc.). Damage to the keypad or touchscreen resulting from this practice will NOT be covered under warranty.

To Enter Setup

1. Press  key to turn the scale on.
2. The scale will show the Detecto logo briefly and then change to the Weight screen.
3. With the Weight screen displayed, press the **Menu** key.
4. The display will change to show the Setup Review screen.

MENU		PAGE 0
Setup Review		
Audit Trail – Cal=16, Cfg=30		
Range 1: 600.0 x 0.2		
Range 2: 1000.0 x 0.5		
Weight Units=lb	Height Units=IN	
Auto Lock=7 Sec	Sonar Ht=223.3 cm	
Motion=3 div.	Filter=Off	
ZeroTrack=10/2 d	Power up zero =Yes	
Gravity=1.000000	OIML=No	
	Exit	Setup

5. Press **Setup** on the touchscreen.
6. The display will change to show the ENTER PASSWORD screen.
7. Using the 10-key on the touchscreen, enter 64870 and then press the **Save** key.
8. The scale is now ready for setup and calibration

Menu Functions

After pressing the **Menu** key to enter the Setup menu, the first screen of the menu is a Setup Review screen where all of the settings can be reviewed at a glance. The Audit Trail Counters for the metrological settings and the non-metrological settings are available for review on this screen as well. Each prompt in the menu screens will show the current value of the setting next to the prompt to easily identify what the current setting for that parameter is.

Setup Menu Keys

- Press the **Setup** key on the Setup Review screen to enter into the scale configuration.
- Press the >>> key on the bottom right of the Setup Menu screen to advance to the next menu page.
- Press the <<< key at the bottom left of the Setup Menu screen to return to the previous menu page.
- Press the **Exit** key to exit Setup and return to the Weight screen.

Setup Menu Page 1

MENU		PAGE 1
Cal=16, Cfg=30		
Units: lb, in		
Auto Locking: 7 sec.		
Sonar Ht: 223.3 cm		
<<<	Exit	>>>

Cal=XX, Cfg=YY – Audit Trail Counters

These are the Audit Trail Counters for the number of times that the metrological and non-metrological settings have been changed. This is for information purposes only.

Units:

Touching this key will toggle the weighing and height units between (lb, in) or (kg, cm). Note that the units cannot be toggled if OIML is enabled.

NOTE: When you calibrate the scale, ensure that the proper base units are selected here before attempting to calibrate. It is safe to change the units without calibrating, just be sure not to change any other metrological settings when you are using the converted units as this may place your calibration to an invalid state.

Allowable settings are: lb, in (pounds, inches) or kg, cm (kilograms, centimeters)

Auto Locking:

This setting is used by the scale to hold a stable patient weight for a desired amount of time. For example, if a value of 5 seconds is used, then when the scale locks onto a stable patient weight, it will remain locked for 5 seconds before automatically releasing the weight.

Touching this key will open the entry screen for the auto-locking feature of the scale. The value entered is a time in seconds. Using the numeric keys, enter a new value and then press the **Save** key to save it.

Allowable values for auto locking are: 0 to 60.

Sonar Ht:

This is the height in centimeters from the scale platform cover to the bottom of the sonar sensor enclosure. This value is used to determine the patient's height and should be measured and entered as accurately as possible to guarantee accurate height measurements using the sonar height rod.

Touching this key will open the entry screen for the sonar sensor height. The value entered is in centimeters. Using the numeric keys, enter a new value and then press the **Save** key to save it.

- Press the >>> key to advance to the Setup Menu Page 2.
- Press the <<< key to return to the Setup Review screen.
- Press the **Exit** key to exit Setup and return to the Weight screen.

Setup Menu Page 2

MENU		PAGE 2
Capacity1: 600.0		
Capacity2: 1000.0		
Interval1: 2		
Interval2: 5		
<<<	Exit	>>>

Capacity1:

Touching this key will open the capacity screen. This will allow you to set the capacity of the first range. Using the numeric keys, enter a new value and then press the **Save** key to save it.

The first range of the scale should be set to 600.0.

Capacity2:

Touching this key will open the capacity entry screen for the second weight range. This value **MUST** be greater than Capacity1 if used. Using the numeric keys, enter a new value and then press the **Save** key to save it.

The second range of the scale should be set to 1000.0.

NOTE: To disable the second weight range, set Capacity2 to a value of (0) zero.

Interval1:

Touching this key will open the interval entry screen. This will allow you to set the scale interval for the first range. Using the numeric keys, enter a new value and then press the **Save** key to save it.

Allowable values for interval 1 are" 1, 2, or 5.

Interval2:

If a second range capacity has been set, then Interval 2 will be used as the interval of the second weight range if enabled (see Capacity2). Using the numeric keys, enter a new value and then press the **Save** key to save it.

Allowable values for interval 1 are: 1, 2, or 5.

- Press the >>> key to advance to the Setup Menu Page 3.
- Press the <<< key to return to the Setup Menu Page 2.
- Press the **Exit** key to exit Setup and return to the Weight screen.

Setup Menu Page 3

MENU		PAGE 3
Decimal1: 1		
Decimal2: 1		
Motion Range: 3		
Filter Mode: 0		
<<<	Exit	>>>

Decimal1:

Touching this key will open the decimal entry screen. This will allow you to set the decimal point precision for the first weight range. Using the numeric keys, enter a new value and then press the **Save** key to save it.

Allowable values for decimal point precision are: 0 – 3.

Decimal2:

Touching this key will open the decimal entry screen. This will allow you to set the decimal point precision for the second weight range if enabled (see Capacity2). Using the numeric keys, enter a new value and then press the **Save** key to save it.

Allowable values for decimal point precision are: 0 – 3.

Motion Range:

Touching this key will open the motion range entry screen. This will allow you to set the number of scale divisions of movement that will be allowed for stable. Using the numeric keys, enter a new value and then press the **Save** key to save it.

Allowable values for motion are: 0 – 20.

Filter Mode:

Pressing this key will open the weight filtering screen. This will allow you to set the amount of digital filtering being applied to the scale. Using the numeric keys, enter a new value and then press the **Save** key to save it.

Allowable settings are: 0 = Off, 1 = Minimal, 2 = Moderate, and 3 = Maximum

- Press the >>> key to advance to the Setup Menu Page 4.
- Press the <<< key to return to the Setup Menu Page 3.
- Press the **Exit** key to exit Setup and return to the Weight screen.

Setup Menu Page 4

MENU		PAGE 4
Zero Tracking: 10		
Power up Zero: Yes		
Gravity: 1.000000		
OIML: No		
<<<	Exit	>>>

Zero Tracking:

Touching this key will open the zero tracking screen. This will allow you to set the number of half (1/2) divisions that the scale will attempt to maintain zero. Using the numeric keys, enter a new value and then press the **Save** key to save it.

Allowable settings for zero tracking are: 0 – 100.

Power up Zero:

Touching this key will toggle the power up zeroing of the scale to Yes or No. If enabled, this will cause the scale to attempt to zero the scale on power up.

Allowable values for Power up Zero are: Yes or No.

Gravity:

Gravity compensation accounts for latitudes and elevations that are different from where the scale was calibrated at. In order to calculate the value for this parameter, use the gravitational constant of the location where the scale was calibrated divided by the gravitational constant of where the scale will be installed:

$$\frac{\text{Gravitational Constant (Calibration location)}}{\text{Gravitational Constant (Operation location)}} = \text{value}$$

This should give you a value close to 1 that you can enter in to compensate for variation in gravity due to elevation/latitude.

Touching this key will open the gravity compensation entry screen. Using the numeric keys, enter a new value and then press the **Save** key to save it.

NOTE: If you do not wish to use the compensation feature, it must be set to 0 (zero) in order to disable it.

OIML:

Touching this key will toggle the OIML setting to Yes or No. The prompt window will show the current state of the OIML setting. This setting should be enabled for all EU models to comply with regulations.

Allowable values for OIML are: Yes or No.

- Press the >>> key to advance to the Setup Menu Page 5.
- Press the <<< key to return to the Setup Menu Page 4.
- Press the **Exit** key to exit Setup and return to the Weight screen.

Setup Menu Page 5

MENU		PAGE 5
Model: Icon		
Calibrate Scale		
<<<	Exit	

Model:

This will change the default settings and operation of the scale. For instance, select “Icon” as the model in order to use the stand-up type scale with the sonar height measurement. For wheelchair type scales with tare functionality, select “Wheelchair” as the model.

Touch this key to open the model selection screen. Using the numeric keys, enter a new value and then press the **Save** key to save it.

Allowable settings are: 0 = icon, 1 = Wheelchair and 2 = Other

Calibrate Scale

Touching this key will allow for calibration of the scale. The scale display will first prompt for the loaded calibration weight. Enter in the weight that will be used to calibrate the scale and touch the **Save** key. The scale will perform the loaded calibration and then prompt for you to unload the scale. Make sure all weight has been removed from the scale before selecting **Save** to perform the unloaded calibration.

You will be returned to the menu when calibration is complete.

- Press the <<< key to return to the Setup Menu Page 4.
- Press the **Exit** key to exit Setup and return to the Weight screen.

SCALE CALIBRATION

To Enter Calibration Setup

1. Enter the Setup menu of the scale by pressing the **Menu** key.
 2. Enter in the desired setup parameters for the scale.
 3. Select Calibrate Scale from the Setup Menu Page 5.
 4. Make certain the scale platform is empty and free of debris.
 5. Place the desired amount of calibrated test weights on the scale platform. A minimum of 50% of scale's capacity is required. However 70% to 100% is recommended.
 6. Enter the amount of the test weight into the Calibration menu screen and touch the **Save** key.
 7. Wait while the scale performs the loaded calibration.
 8. When the loaded calibration is complete, the scale display will prompt to unload the scale.
 9. Remove any weight from the scale platform and touch the **Save** key.
 10. Wait while the scale performs the zero calibration.
 11. The scale display will return to the Setup Menu screen when the calibration is complete.
- Press the **Exit** key to exit Setup and return to the Weight screen.

This page intentionally left blank.

ERROR AND OPERATION MESSAGES

The icon scale is equipped with diagnostic software that tests various portions of the scale's circuitry and verifies proper operation. Should a problem be detected, an error or status message will be displayed. The following lists these messages and their meaning.

AUTO LOCKED

This message appears if the weight/height has been automatically locked.

BELOW ZERO

The scale weight reading is below zero.

CAL REQUIRED

The scale requires calibration, weight will show as dashes. Consult your scale service representative.

CENTER ZERO

The scale weight reading is at center of zero.

ERROR CANNOT ZERO

Scale cannot zero due to motion on scale.

LOCKED

This message appears if the weight/height has been manually locked.

MOTION

The scale is in motion based on motion range setting.

OVER CAPACITY

The scale weight exceeds scale capacity.

OVERFLOW ERROR

This message appears if there are too many characters to display on the screen. This message appears if there are too many characters to display on the screen.

BEFORE YOU CALL FOR SERVICE

Problem	Possible Solutions
Display does not turn on	<p>AC Operation:</p> <ul style="list-style-type: none"> • Is AC power supply fully inserted into wall receptacle? • Check wall receptacle for proper AC power. Try another electrical appliance in same receptacle, does it work? • Check circuit breaker. • Has there been power failure? <p>Battery operation:</p> <ul style="list-style-type: none"> • Check if batteries are installed and correctly. • If Alkaline, remove old batteries and replace with new ones. • If NI-CAD or NiMH, remove discharged batteries and replace with fully charged ones. Place discharged batteries in an external charger to recharge.
Incorrect weight is displayed	<p>Insure that scale platform isn't touching an adjacent object. Have proper operation procedures been followed?</p>
Weight is not displayed	Refer to Error and Operation Messages.

CARE AND CLEANING



NOTE: The scale contains no user-serviceable parts and maintenance should be limited to an occasional cleaning and battery replacement as required.

- Do not submerge the scale in water, pour or spray water directly on it to clean. The scale is not waterproof and covering it with water will damage it and void the warranty.
- Always remove power before cleaning.
- Do not use wire brushes, abrasives, or cleaning tools such as steel pads and scrapers, which will scratch the painted surface. Instead, use soft cloths or plastic scouring pads for cleaning.
- When possible use treated water. Hard water can leave behind deposits. Soft water is much gentler on the painted steel's surface.
- Avoid the use of acetone, thinner or other volatile solvents and abrasive type cleaners for cleaning. If required, a mild solvent such as mineral spirits can be used to remove oil, grease, tars, wax, and similar substances. Use a cloth dampened with mineral spirits and apply only to areas that are contaminated. Follow up the use of this mild solvent with detergent cleaning and rinsing.

PARTS IDENTIFICATION

Final Assembly

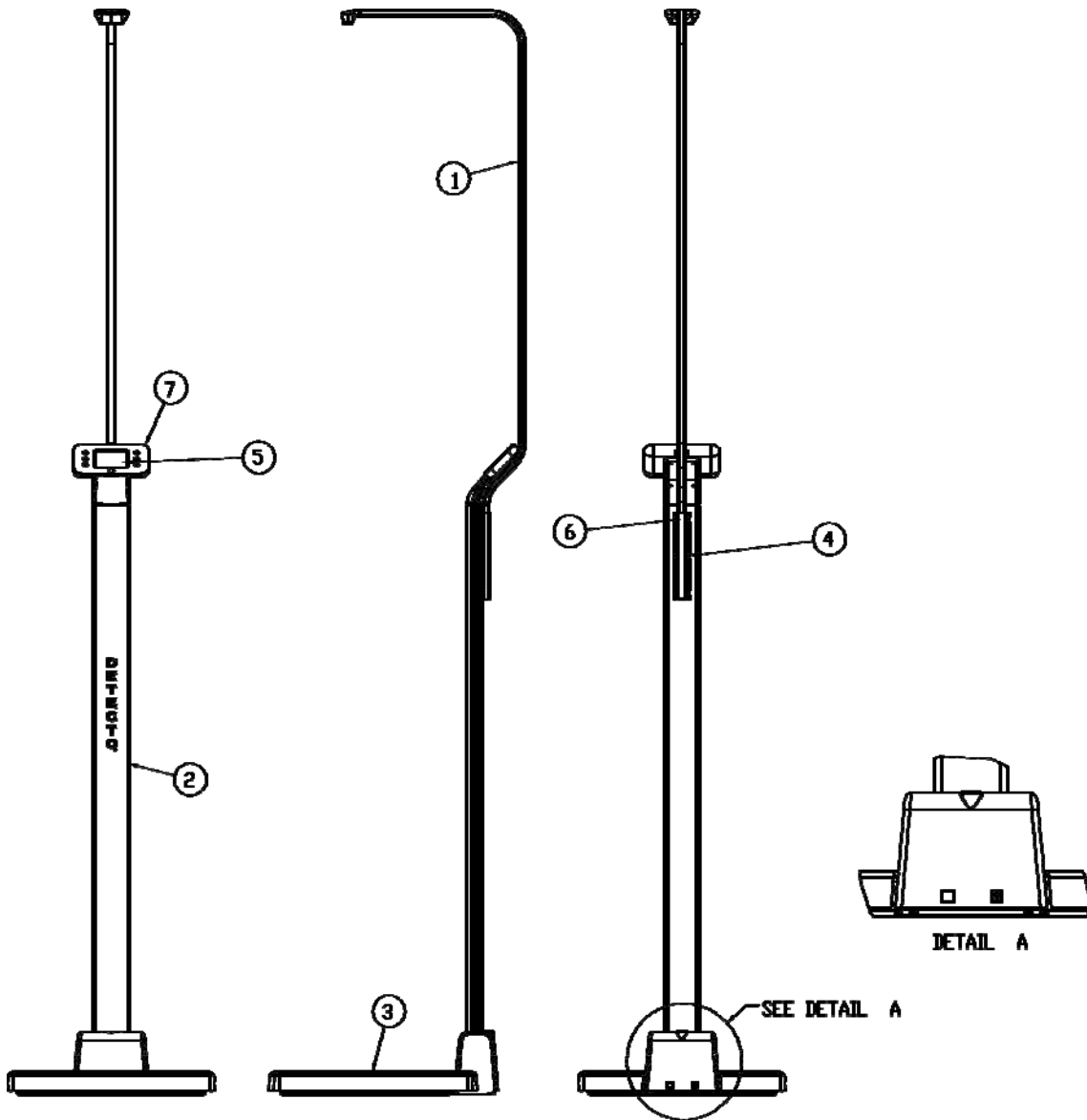

Item	Qty.	Part Number	Description
1	1	3300-0140-0A	SUB-ASSY, SONAR HR
2	1	3300-0141-0A	SUB-ASSY, ICON COLUMN
3	1	3300-0144-0A	SUB ASSY, ICON BASE
4	1	3300-0265-08	SONAR BRACKET
5	2	6021-1293	SCW FLAT-HEAD THREAD CUTTING TYPE 25, #4-24 X 1/4, PHIL. DR. Z-PLATE
6	6	6021-6016	SCW PAN-HEAD,, SHEET METAL #6X.50
7	1	3300-0151-0A	SUB-ASSY, DISPLAY, ICON
*	1	6800-1045	AC ADAPTER 100-240VAC/12VDC @ 1 AMP

* NOT SHOWN

PARTS IDENTIFICATION

Sonar HR Sub-Assembly

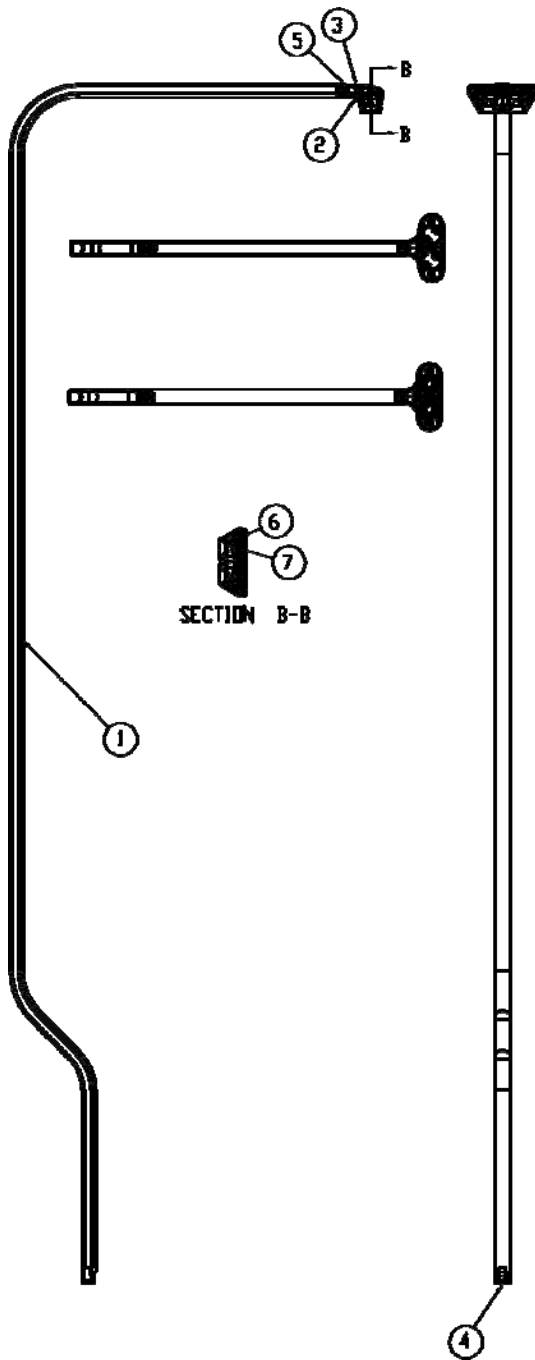

Item	Qty.	Part Number	Description
1	1	3300-0022-08	HEIGHT SENSOR TUBE
2	1	3300-0060-08	SONAR FRONT ENCLOSURE
3	1	3300-0061-08	SONAR REAR ENCLOSURE
4	1	3300-0135-0A	CABLE, ICON/APEX SONAR
5	1	6021-1293	SCW FLAT-HEAD THREAD CUTTING TYPE 25, #4-24 X 1/4, PHIL. DR. Z-PLATE
6	2	6021-2078	SCW PAN HEAD PHILIPS #1-32X3/8" THREAD FORMING, 18-8 SS
7	1	6600-0756	ULTRASONIC RANGING MODULE

PARTS IDENTIFICATION

Column Sub-Assembly

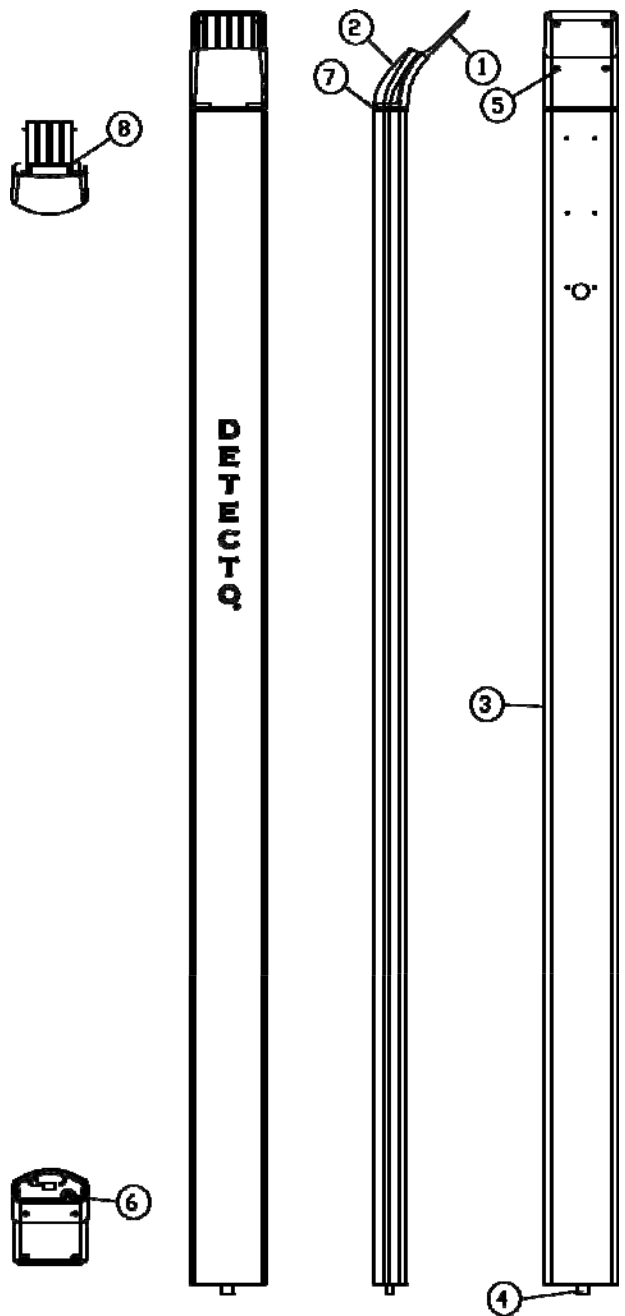

Item	Qty.	Part Number	Description
1	1	3300-0067-08	THROAT REAR
2	1	3300-0068-08	THROAT FRONT
3	1	3300-0087-08	COLUMN, DRILLED & SONAR
4	1	3300-0278-1A	CABLE, APEX COLUMN, SONAR
5	2	6021-1293	SCW FLAT-HEAD THREAD CUTTING TYPE 25, #4-24 X 1/4, PHIL. DR. Z-PLATE
6	1	6021-1509	SCW PAN-HEAD, SHEET METAL #8X.75
7	1	6650-1114	O-RING 2 ID X 2-3/16 OD X 3/32 THK
8	A/R	6710-1021	TAPE 1.88" X 60YDS DUCT ROLL

PARTS IDENTIFICATION

Display Sub-Assembly

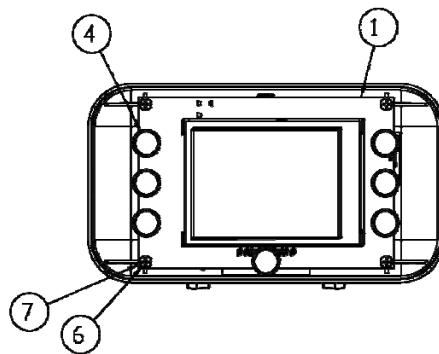
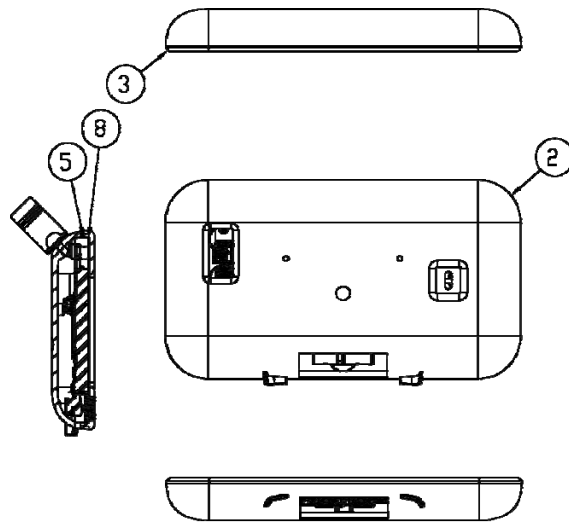

VIEW WITH FRONT DISPLAY AND UNDERLAY REMOVED

Item	Qty.	Part Number	Description
1	1	3300-0002-0A	PCB ASS'Y 855 DISPLAY
2	1	3300-0050-08	DISPLAY ENCLOSURE
3	1	3300-0051-08	DISPLAY FRONT, ICON
4	7	3300-0071-08	ICON BUTTONS
5	1	3300-0090-08	UNDERLAY FOAM, ICON
6	4	6021-1293	SCW FLAT-HEAD THREAD CUTTING TYPE 25, #4-24 X 1/4, PHIL. DR. Z-PLATE
7	4	6024-0142	WASHER FLAT .250 OD, 0.093 THK NYLON
8	1	3300-0148-08	UNDERLAY, ICON

PARTS IDENTIFICATION

Base Sub-Assembly

Item	Qty.	Part Number	Description
1	8	0065-B636-08	LOAD CELL SPACER
2	1	3300-0001-0A	PCB ASS'Y 855 ANALOG
3	1	3300-0008-0A	BASE WELDMENT
4	1	3300-0035-08	WEIGHBRIDGE
5	1	3300-0053-08	COLUMN CLAMP
6	1	3300-0058-18	SOCKET COVER, ICON
7	1	3300-0088-08	ICON COVER PLATE
8	1	3300-0130-1A	ICON ANALOG CABLE
9	1	3300-0137-0A	CABLE, ICON BATTERY
10	1	3300-0147-1A	SUB-ASSY, PLATFORM COVER, ICON
11	1	3300-0266-08	COLUMN CONNECTOR BRACKET, ICON
12	4	6013-0049	NUT 1/4-20 HEX JAM
13	8	6013-0295	NUT #10-32 HEX Z/P
14	4	6013-2008	NUT 1/4-20 CAGE Z/P
15	2	6021-0654	SCW PAN-HEAD,, MACHINE-SCW 06-32X.250
16	4	6021-1033	SCW ROUND-HEAD MACHINE-SCW 10-32X.250
17	4	6021-1417	SCW SOCKET-HD. CAP-SCREW,, 25-20X2.0
18	4	6021-1473	SCW PAN-HEAD,, MACHINE-SCW .25-20X.3125
19	8	6021-1638	SCW HEX/WASHER,, SELF-TAP 10-32X.625, Z/P
20	8	6024-0033	WASHER LOCK HELICAL SP #10 REG Z-PL
21	4	6031-0223	VIBRATION MOUNT, 1/4" – 20 MALE-FEMALE, 1" OD, 1/2" BASE HEIGHT
22	A/R	6560-1061	ADHESIVE LOCTITE 262-21 THREADBLOCKER, HS
23	A/R	6560-1125	ADHESIVE LOCTITE 290 THRD LCKR, WICKING
24	1	6690-0001	LEVEL, "BULLSEYE" TYPE
25	A/R	6710-1021	TAPE 1.88" X 60YDS DUCT ROLL
26	1	593GR986	SERIAL TAG ASSY
27	4	FP-250	LOAD CELL, FLAT PLATE, 250 LBS

PARTS IDENTIFICATION

Base Sub-Assembly

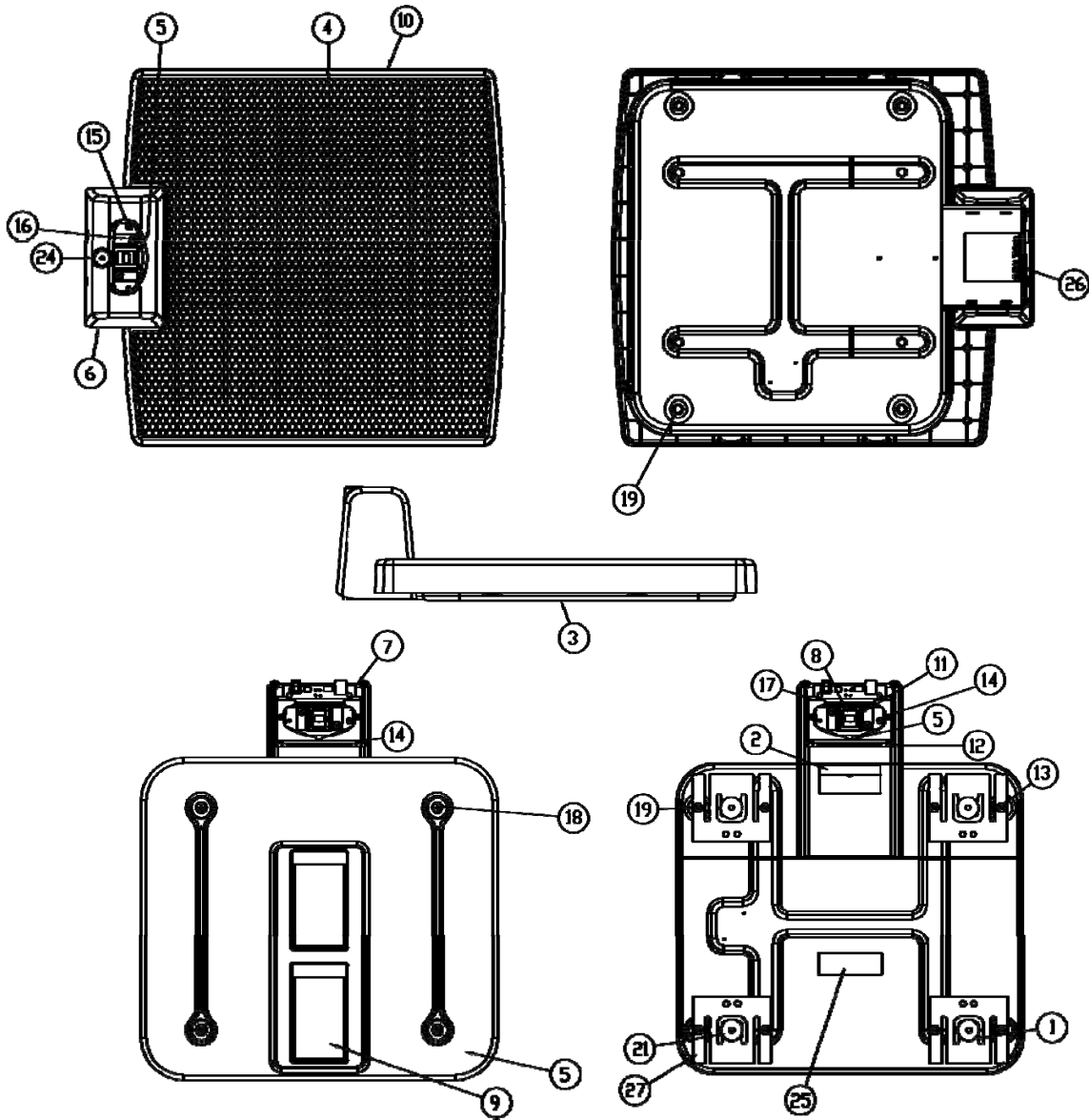

STATEMENT OF LIMITED WARRANTY

Detecto Scale warrants its equipment to be free from defects in material and workmanship as follows: Detecto warrants to the original purchaser only that it will repair or replace any part of equipment which is defective in material or workmanship for a period of two **(2) years from date of shipment**. Detecto shall be the sole judge of what constitutes a defect.

During the **first ninety (90) days** Detecto may choose to replace the product at no charge to the buyer upon inspection of the returned item.

After the first ninety (90) days, upon inspection of the returned item, Detecto will repair or replace it with a remanufactured product. The customer is responsible for paying for the freight both ways.

This warranty does not apply to peripheral equipment not manufactured by Detecto; this equipment will be covered by certain manufacturer's warranty only.

This warranty does not include replacement of expendable or consumable parts. This does not apply to any item which has deteriorated or damaged due to wear, accident, misuse, abuse, improper line voltage, overloading, theft, lightning, fire, water or acts of God, or due to extended storage or exposure while in purchaser's possession. This warranty does not apply to maintenance service. Purchased parts will have a ninety (90) day repair or replacement warranty only.

Detecto may require the suspect product to be returned to the factory; item(s) must be properly packed and shipping charges prepaid. A return authorization number must be obtained for all returns and marked on the outside of all returned packages. Detecto accepts no responsibility for loss or damage in transit.

STATEMENT OF LIMITED WARRANTY

Conditions Which Void Limited Warranty

This warranty shall not apply to equipment which:

- A.) Has been tampered with, defaced, mishandled or has had repairs and modifications not authorized by Detecto.
- B.) Has had serial number altered, defaced, or removed.
- C.) Has not been grounded according to Detecto's recommended procedure.

Freight Carrier Damage

Claims for equipment damaged in transit must be referred to the freight carrier in accordance with freight carrier regulations.

This warranty sets forth the extent of our liability for breach of any warranty or deficiency in connection with the sale or use of the product. Detecto will not be liable for consequential damages of any nature, including but not limited to, loss of profit, delays or expenses, whether based on tort or contract. Detecto reserves the right to incorporate improvements in material and design without notice and is not obligated to incorporate improvements in equipment previously manufactured.

The foregoing is in lieu of all other warranties, express or implied including any warranty that extends beyond the description of the product including any warranty of merchantability or fitness for a particular purpose. This warranty covers only those Detecto products installed in the forty-eight (48) contiguous continental United States.



Ph. (800) 641-2008
E-mail: detecto@cardet.com
203 E. Daugherty
Webb City, MO 64870

08/27/2014
Printed in USA
D268-WARRANTY-DET-A



Printed in USA

3300-0192-0M Rev D 01/17



203 E. Daugherty, Webb City, MO 64870 USA

Ph: 417-673-4631 or 1-800-641-2008

Fax: 417-673-2153

Technical Support: 1-866-254-8261

E-mail: tech@cardet.com