

LUXE Bidet®

OWNER'S MANUAL



Model: Neo 120

Thank you for choosing Luxe Bidet®. This manual contains important information regarding your unit. Before operating the unit, please read this manual thoroughly, and retain it for future reference.

LUXE Bidet®

TABLE OF CONTENTS

PRODUCT INFORMATION

Product Features	page 1
Why Luxe Bidet?	page 2
Specifications	page 3
Product Dimensions	page 3
Parts List	page 4

PRODUCT INSTALLATION

Before Installation	page 5
Installation	page 7

PRODUCT OPERATION

Troubleshooting	page 10
FAQs	page 13

WARRANTY	page 15
-----------------------	---------

CONTACT	page 16
----------------------	---------

PRODUCT INFORMATION

PRODUCT FEATURES

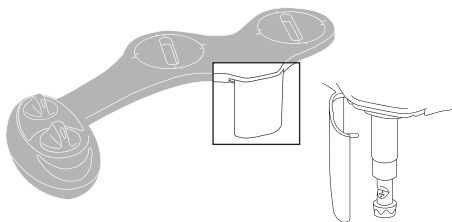

Single Nozzle Design

The Luxe Bidet Neo 120 features a regular wash nozzle that is hygienic and reduces the use of toilet paper.

Nozzle Guard Gate

The bidet features a convenient, hygienic nozzle guard gate for added protection and easy maintenance. The hygienic nozzle guard gate ensures that the bidet is always ready for clean operation and can open for easy access to the nozzle.

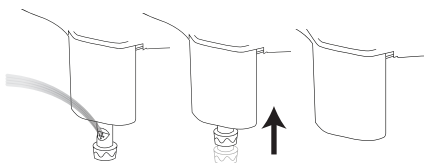
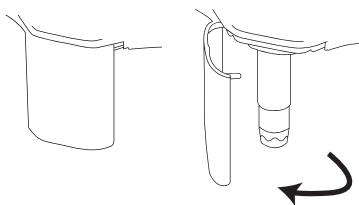

Retractable Nozzle Always Stays Clean

When not in use, the nozzle retracts for hygienic storage allowing for double protection behind the nozzle guard gate.

Convenient Nozzle Cleaning Feature

While the bidet is designed to keep the retractable nozzle clean, this model also features an innovative self-cleaning sanitary nozzle that streams fresh water directly over the nozzle for rinsing before or after use.

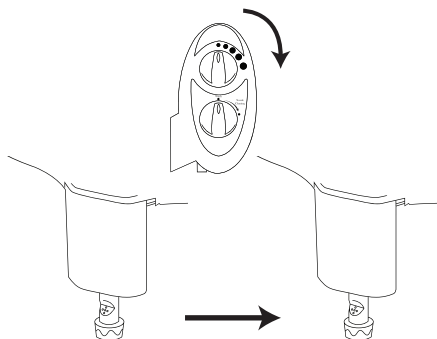
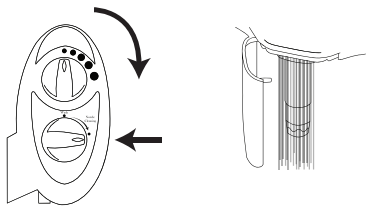

Activate and Adjust Water Pressure Easily

The unobtrusive control panel features a chrome-plated water pressure control knob that allows the user to activate and adjust water pressure. With clearly defined settings, the bidet can easily be operated by children and the elderly.

PRODUCT INFORMATION

WHY LUXE BIDET?



Protects & Restores Forests

Bidets axe zero trees. Help protect our forests!



Easy On Your Skin

Water cleans better and more gently than paper.



Saves the Septic System

With bidets, septic tanks would need to be emptied much less.



Good for the Bottom Line

The cost of a bidet will pay for itself in the money you save not buying toilet paper.



Conserves Water & Energy

Bidets are an environmentally friendly investment.



Simple & Quick DIY Installation

All of our bidets can be installed in less than 30 minutes! No electricity is required.



Women Sanitary Needs

Very beneficial and relieving solution during that time of month, pregnancy, UTI's.



Privacy, Comfort, and Dignity

Improves autonomy and increases bathroom independence for seniors and those with restricted mobility or other medical needs.

Once you bidet, you never go back!

PRODUCT INFORMATION

SPECIFICATIONS

UPC: 895063002784 (blue), 850625005108 (white)

Retail Box Size: 17.6 x 7.1 x 4"

Retail Package Weight: 1.78 lbs

Connection Type: Cold water

Water Control: Chrome-plated dial

Mode Selection Control: Chrome-plated dial

Nozzles: Single-nozzle

Bidet Body Material: ABS resin, plastic bidet inlet

Parts Material: 7/8" x 1/2" metal t-adapter, 1/2" x 1/4" metal braided hose

Valve Construction: Metal-ceramic

Working Pressure: 50 ± 20 psi

Features: Nozzle guard gate

Certifications: ASME A11218.1-2012/CSA, ASME A112.4.2-2009

Manufactured In: China

Bidet Dimensions:

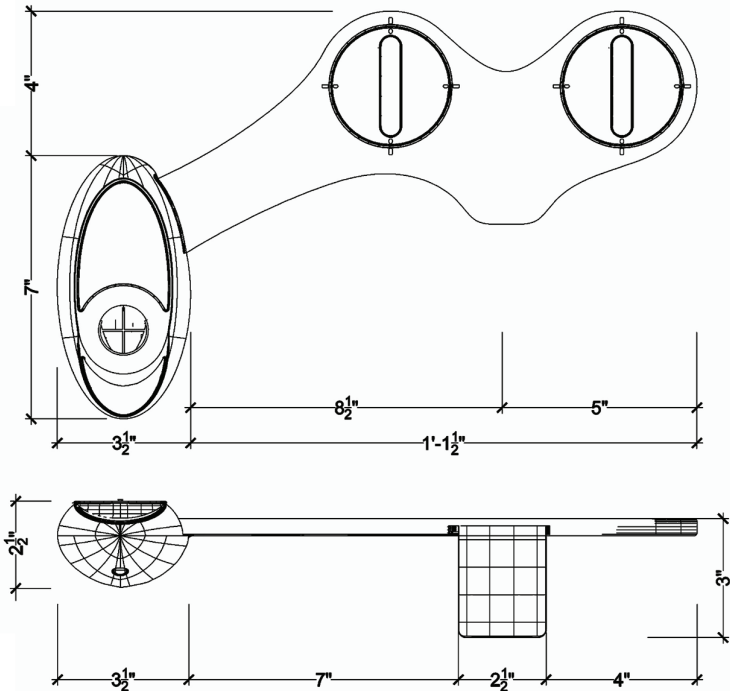

PRODUCT INFORMATION

PARTS LIST

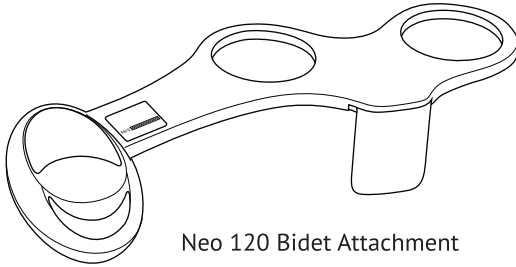

Note: The 7/8" connection can sometimes be referred to as 15/16" but they are the exact same size.

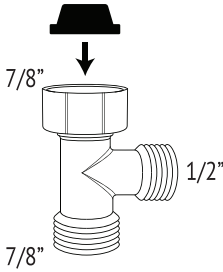

Cold Water Metal T-adapter
(7/8" x 7/8" x 1/2")

SKU Code: MetalT1516

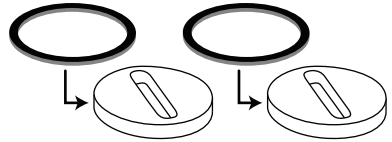

Circular Adjustment Plates (2)
with Rubber Gaskets (2)

SKU Code: NeoAdjustmentPlate

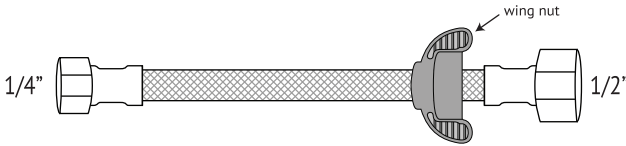

15" Cold Water Bidet Hose
(1/4" x 1/2")

SKU Code: 15inNeoColdHose12to14



Teflon Tape

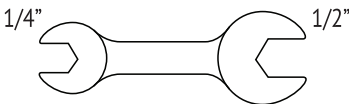

Wrench
(1/4" x 1/2")

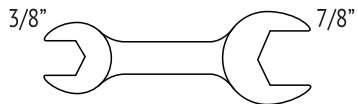

Wrench
(3/8" x 7/8")

BEFORE INSTALLATION

QUICK FACTS BEFORE BEGINNING INSTALLATION

Below are some quick facts about our LUXE Bidet®. They contain information on the most common questions we receive from our current customers, so we hope that you will find them useful during the installation and use of the product.

QUICK FACT #1

The included parts meet North American plumbing standards. However, some homes may have alternative sized fittings. If the included parts do not work for your setup, please contact us right away for assistance with alternative parts.

QUICK FACT #2

The water pressure that comes out of the bidet is the same water pressure of your home. If you have extremely high water pressure, the stream of water coming out of the bidet may feel too strong. We have a solution for this! Please contact us and we will send you a free t-adapter with shut-off valve to reduce the water pressure at the water line.

QUICK FACT #3

For warm water bidets, please be aware that it may take a few moments for the warm water to run through the bidet because you have to wait for the warm water to run through your water pipe, similar to when you are running a bath. To avoid a "cold splash" we recommend that you run the bidet in "self-cleaning mode" prior to using the "wash mode" to ensure that the water is warm.

QUICK FACT #4

Our bidets are compatible with most standard toilet seats, however, certain seat styles (such as those with a curved inner lip) may result in a gap between the toilet seat and bowl after the bidet is installed. If you have a gap that is under 1 inch, please contact us and we will send you a free set of LUXE Bidet® Toilet Seat Bumpers. If the gap is larger than 1 inch, you may need to purchase a different style toilet seat. We highly recommend using our LUXE® Toilet Seats with our bidet attachments for a seamless, gap-free installation. LUXE® Toilet Seats can be purchased at www.LuxeBidet.com.

**20%
OFF!**

REDEEM OFFER

Use your Bidet ID to get 20% off a LUXE Toilet Seat. Please contact us at www.LuxeBidet.com or customer@luxebidet.com for more information.

BEFORE INSTALLATION

LOCATE AND RECORD YOUR BIDET ID

Locate your Bidet ID and write it down below.

Bidet ID: _____

The Bidet ID is required for registering your bidet for a 2-year extended warranty.

The Bidet ID can be located on the sticker attached to the arm of the bidet AND on the bottom of the bidet's control panel.

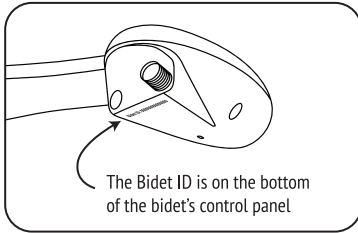

AND

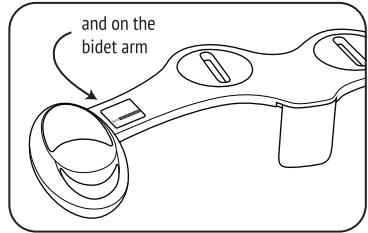

CONFIRM ACCESS TO THE TOILET TANK FILL VALVE

Check that you have access to the fill valve under the toilet tank.

The provided cold water t-adapter should be installed at the fill valve under the toilet tank (as pictured below), NOT at the cold water supply valve coming from the wall.

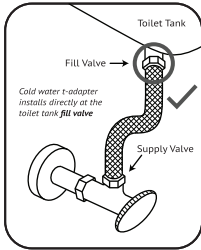

CORRECT

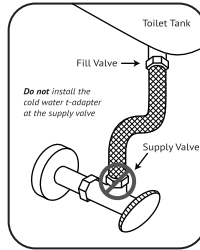

INCORRECT

If you do not have access to the fill valve under the toilet tank, contact Luxe Bidet Customer Support at 858-360-7780 or customer@luxebidet.com for alternative installation options.

CONFIRM THAT YOUR WATER SUPPLY LINE IS FLEXIBLE

Check that your toilet tank water supply line is flexible.

If your toilet tank water supply line is a rigid pipe, you will need to replace this pipe with a flexible water supply hose before installing the bidet.

The length of the hose you purchase may vary, but the top connection size should be 7/8" Ballcock (to connect to the provided t-adapter) and the bottom connection size should be 3/8" or 1/2" (to connect to your water supply valve).

PRODUCT INSTALLATION

INSTALLATION

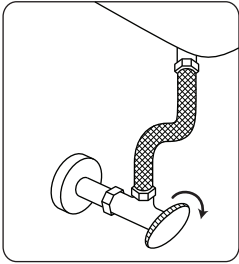

Step 1

Step 1 - Turn Off the Toilet Tank Water Supply

Turn off the toilet tank water supply at the wall to stop the flow of water (most valves will need to be turned clockwise). Flush the toilet and hold down the handle to completely empty the toilet tank.

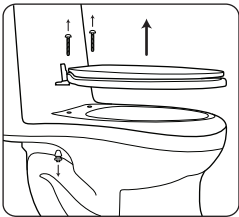

Step 2

Step 2 - Remove the Toilet Seat

To remove the toilet seat, lift the hinge tabs and use a flathead screwdriver to unscrew the toilet seat bolts while holding the nuts on the underside of the bolts in place. Remove the toilet seat and toilet seat bolts and nuts and set them aside.

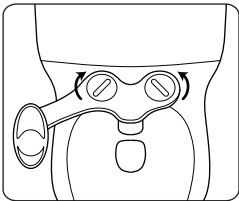

Step 3

Step 3 - Mount Your Luxe Bidet on the Toilet

Place the bidet attachment on the toilet. The adjustment plates will need to line up with the holes on the toilet bowl. You may need to rotate the adjustment plates accordingly to line up properly with the holes.

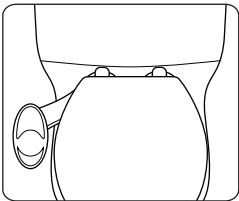

Step 4

Step 4 - Reattach Your Toilet Seat

Reattach the toilet seat on top of the bidet attachment and secure it using the original toilet seat hardware. Make sure to tighten the bolts to ensure that the bidet attachment and toilet seat do not move.

PRODUCT INSTALLATION

INSTALLATION (cont.)

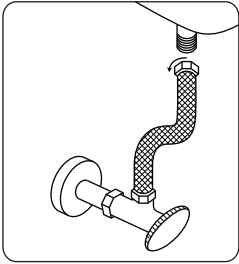

Step 5

Step 5 - Disconnect the Water Supply Hose

Make sure you have turned off the toilet tank water supply and flushed the toilet to empty the toilet tank if you have not done so already. Place a towel or bucket underneath the toilet tank connection to catch any residual water, then disconnect the water supply hose from the toilet tank.

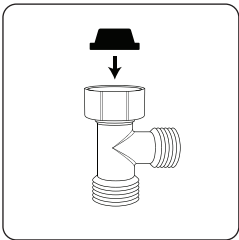

Step 6

Step 6 - Check the T-adapter

Make sure that there is a black rubber washer inserted at the top of the t-adapter. If it is not already there, insert the black rubber washer so it is securely in place, as shown in the picture.

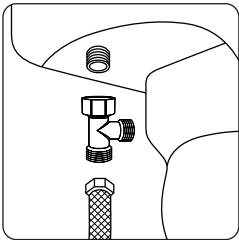

Step 7

Step 7 - Install the T-adapter to the Toilet Tank

Connect the top of the t-adapter to the toilet tank and the bottom of the t-adapter to the water supply hose.

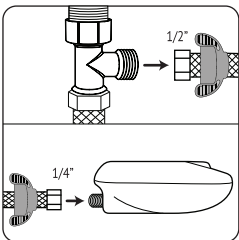

Step 8

Step 8 - Connect the Bidet Hose to the T-adapter and Inlet

Connect the 1/2" end of the cold water metal braided bidet hose to the t-adapter. Connect the 1/4" end of the hose to the bidet inlet.

Tip: Use the wing nut of the hose to fully tighten the connections at both ends of the hose.

PRODUCT INSTALLATION

INSTALLATION (cont.)

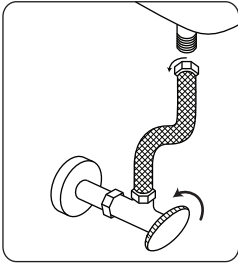

Step 9

Step 9 - Turn on the Toilet Tank Water Supply

Turn on the toilet tank water supply.

Congratulations! You are ready to use the Luxe Bidet for the first time. Gently turn the water pressure control knob to reach your desired spray pressure.

ASSEMBLED UNIT

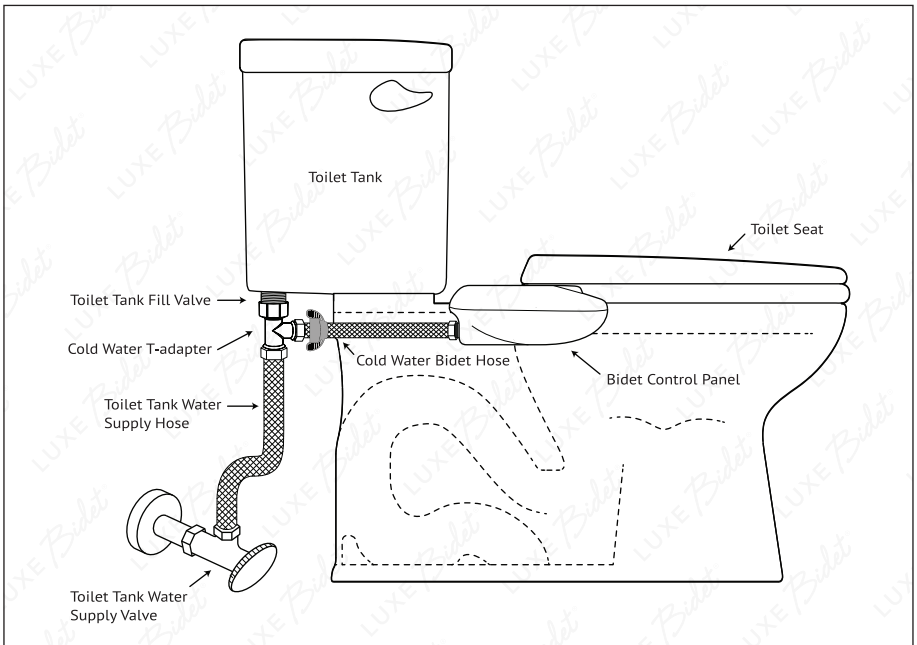

PRODUCT OPERATION

TROUBLESHOOTING

Problem	Possible Causes	Possible Solutions
After installing the bidet, the toilet seat does not rest flat on the toilet bowl.	<ol style="list-style-type: none">1. The toilet seat has outer hinge tabs.2. There is a curve underneath the toilet seat.	<ol style="list-style-type: none">1. If the extra space is 1/2" or less, install toilet seat bumpers (available on luxebidet.com).2. Find a toilet seat that is flat at the bottom and does not come with outer hinge tabs.
The self-cleaning nozzle feature is not running any water.	The water flow may not be activated, so water cannot flow through the bidet to clean the nozzles.	First, turn the lower knob to 'Nozzle Cleaning' then lift or turn the water flow lever or knob, respectively, to allow water to flow over the nozzles.
The nozzle gets stuck or does not extend / retract properly.	<ol style="list-style-type: none">1. There may be hard water deposit(s) in or around the nozzle.2. The nozzle is too close to the toilet tank.	<ol style="list-style-type: none">1. Gently pull the nozzle up and down a few times to loosen it, or you can also try cleaning it with paper towels soaked in vinegar to safely dissolve any hard water build up.2. Move the bidet forward to make clearance for the nozzle to extend.
The water flow from the bidet is too strong.	<ol style="list-style-type: none">1. The water supply valve is opened too much.2. The household water pressure or flow is very high.	<ol style="list-style-type: none">1. Turn the water supply valve counter-clockwise to decrease the water flow.2. Install a Luxe Metal T-adaptor with Shut-off Valve to reduce the water flow going into the bidet.
The toilet or hose(s) make a loud banging sound after flushing the toilet.	Some air bubbles may have become trapped in the pipes during installation.	Turn off the water supply, uninstall all parts of the bidet, reattach the water supply hose, flush the toilet to empty it, then, reinstall the bidet.

PRODUCT OPERATION

TROUBLESHOOTING (cont.)

Problem	Possible Causes	Possible Solutions
The toilet tank is filling up slower than normal after installing the bidet.	The water supply valve may not be fully opened.	Turn the water supply valve clockwise to allow more water to flow to the toilet.
Water sprays straight down into the toilet tank instead of upwards during use.	The nozzle cap(s) that screw onto the bottom of the nozzle(s) is missing.	A replacement nozzle cap can be purchased on the Accessories page on luxebidet.com .
When the bidet is turned on, no water comes out of the nozzle.	<ol style="list-style-type: none">1. There may be hard water deposit(s) in or around the nozzle.2. The water flow knob / lever is not turned on.3. The t-adapter is not connected properly.4. The toilet seat or bowl is blocking the nozzle(s) from extending.	<ol style="list-style-type: none">1. Gently pull the nozzle up and down a few times to loosen it, or you can also try cleaning it with paper towels soaked in vinegar to safely dissolve any hard water build up.2. Turn the nozzle mode knob to 'Wash' and turn / lift the water flow knob / lever to activate the bidet.3. Check that the t-adapter is tightened all the way so water can flow through it.4. Reposition the bidet on the toilet bowl to create clearance for the nozzle(s).
The nozzle(s) are spraying off-center or to the side.	<ol style="list-style-type: none">1. The nozzle(s) holes are not facing forward properly.2. The bidet is not installed completely straight.	<ol style="list-style-type: none">1. Open the guard gate to allow access to the nozzle(s), then fully retract the nozzle(s) into the bidet and turn the nozzle(s) counter-clockwise until the holes face forward.2. Adjust the positioning of the bidet on the toilet by a few degrees.

PRODUCT OPERATION

TROUBLESHOOTING (cont.)

Problem	Possible Causes	Possible Solutions
The toilet seat bolts do not properly affix to the toilet after installing the bidet.	Some toilet seat bolts are shorter than required to accommodate the bidet.	Install longer toilet seat bolts that will accommodate the extra space of the bidet.
The cold water t-adapter is leaking.	<ol style="list-style-type: none">1. The black rubber washer is not properly installed.2. The t-adapter threads were cross-threaded or stripped during installation.3. There is a mismatch in the threading.	<ol style="list-style-type: none">1. Make sure that the black washer is seated flat side down on the top connection of the t-adapter.2. Contact us via luxebidet.com to request a replacement t-adapter.
There is leaking from the bidet body or hose connections.	<ol style="list-style-type: none">1. The black rubber washer(s) are not properly installed on the hose.2. The bidet inlet threads were cross-threaded or stripped during installation.3. The bidet or hose may be defective (very rare).	<ol style="list-style-type: none">1. Make sure that the black washer(s) are properly installed on both ends of the hose.2. Contact us via luxebidet.com to request a replacement.
The water supply hose cannot be unscrewed from the toilet tank and/or the water supply valve.	The water supply hose is permanently attached to the plumbing.	Please contact us via luxebidet.com to request alternative installation parts.
There is no room to fit the t-adapter between the water supply hose and toilet tank.	The water supply hose is rigid or a solid pipe.	Replace the rigid water supply hose with a flexible hose (available on luxebidet.com).
The nozzle sprays too far forward.	The bidet is positioned too closely to the front of the toilet.	Reposition the bidet by pushing it back, towards the toilet tank.

PRODUCT OPERATION

FAQ

Do the nozzle(s) always stay out when not in use?

The nozzle is retractable and only comes out when the water is turned on.

What kind of material is the bidet body made from?

Luxe Bidets are made from very strong (yet light and flexible) plastic. The smooth, high quality plastic is easy to clean and looks great on any toilet.

How do I clean or maintain the bidet?

You may wipe the bidet with a disinfectant wipe, or a soft rag or toilet paper soaked with a mild household cleaning solution.

What is the teflon tape for and how should I use it?

Teflon tape (also known as plumber's tape) can be wrapped around the threads of any connection (such as the toilet tank, t-adapter, or the bidet inlet threads) to help tighten up the seal and prevent leaking. It is an optional step for optional precaution against leaking. This may be useful and/or necessary if the threads seem worn out.

Does the bidet come with a warranty?

Yes, all Luxe Bidets come with an 18 month warranty which starts from the day of purchase. You can extend this warranty to 24 months (2 years) by registering your bidet on luxebidet.com. Please contact us via luxebidet.com if you would like to make a warranty claim.

How do I install the bidet if my toilet seat comes with twist-hinges?

First, unlock the hinge caps by turning them to the left and lift the toilet seat off the bowl. Remove the screws / bolts that the hinges attach to on the toilet bowl, by unscrewing the nuts on the underside of the bowl. Place the bidet on top of the toilet bowl, position the adjustment plates to fit the screw holes, place the screws / bolts on top of the bidet and reattach the nuts under the bowl to secure the screws. Once the bolts are secured to the bidet and toilet bowl, simply snap the seat on top of the bolts by rotating the hinge caps to the right.

Do you carry any toilet seat attachment bidets with left-sided controls?

We currently do not carry any models that have left-sided or left-handed controls.

How can I install the bidet if my toilet has a rigid or inflexible pipe, or if I have no access to my toilet tank connection?

You will need to replace the inflexible pipe with a flexible hose. If you are unable to remove the hard water pipe or have no access to your toilet tank connection, we have an alternative installation method that may work better for you. Please contact us on luxebidet.com for more information.

PRODUCT OPERATION

FAQ (cont.)

What is the purpose of the guard gate? Is it supposed to open automatically?

The guard gate shields the nozzle(s) from debris and should remain closed at all times. During use, the nozzle(s) will drop down below the gate and spray water. When you turn off the bidet, the nozzle(s) will automatically retract behind the gate. You may open it manually to access the nozzle(s) for cleaning.

Some bidets come with two nozzles. What is the difference between the two nozzles?

Our dual nozzle bidets (Neo 180, 185, 320) feature a regular wash nozzle and a feminine wash nozzle. The wash nozzle is the standard nozzle that comes with all Luxe Bidets in the Neo Series, and cleanses the back. The feminine nozzle has a slightly lower angle and softer spray and cleanses the front. The nozzles can be operated separately or at the same time. To activate the nozzles at the same time, you can point the nozzle mode knob between 'Women' and 'Wash'.

For additional troubleshooting tips or FAQ, please feel free to visit our FAQ page at www.LuxeBidet.com.

WARRANTY

WARRANTY INFO

18 Month Limited Warranty

Luxe Bidet® by 2Go Products, LLC was carefully tested before shipment from the Manufacturer, who warrants this product to be free from defects, materials and workmanship for a period of one (18) month from the Date of Purchase, from the distributor.

THIS WARRANTY EXCLUDES THE FOLLOWING:

- (1) Replacement of discolored or damaged parts as a result of use of strong cleaning or disinfecting chemicals.
- (2) Damage to or malfunction of the unit resulting from improper installation, negligence, misuse, abuse or tampering by unauthorized repair personnel.
- (3) Under no circumstance will 2Go Products, LLC be held liable for any loss or damage direct, consequential or incidental arising out of the use of or inability to use this product (some states do not allow this exclusion).
- (4) Owner of the bidet should immediately stop using and uninstall the bidet if there is even a small leaking or dripping detected anywhere due to the bidet. Leakage can result because of incompatibility of the toilet fittings, improper installation, and due to old or damaged parts.
- (5) Exposure to extreme temperatures, strong chemicals such as bleach, hydrochloric acid etc. or high water pressure can cause damage to various parts of the bidet and can result in leaking or flooding. Therefore, the owner hereby releases the manufacturer and sellers of Luxe Bidet from any and all claims for bodily and property damage resulting from such conditions.
- (6) The owner hereby releases the 2Go Products, LLC from any and all claims against damages to the property or the bidet resulting from the misuse, improper installation, inadequate maintenance or exposure to extreme temperature, water pressure or strong chemicals.

Attention: Register your bidet at www.LuxeBidet.com for more efficient support concerning warranty claims, returns, and technical assistance.

It is strongly recommended that the bidet's connecting hoses be inspected and replaced every 3 to 5 years depending on weather-related wear and tear. Please feel free to contact us at www.LuxeBidet.com to get discounted replacement parts for age-related wear and tear.

CONTACT

CONTACT US

If you have any questions or comments, please contact our customer care at any time and we will be able to assist you further. Thank you for choosing Luxe Bidet®

Website: www.LuxeBidet.com

Email: customercare@luxebidet.com

Phone: 858-360-7780

Fax: 858-876-1559

Luxe Bidet HQ

7770 Regents Rd. 113-632

San Diego, CA 92122

United States

LUXE *Bidet*®

Website: www.LuxeBidet.com

Email: customercare@luxebidet.com

Phone: 858-360-7780

Fax: 858-876-1559

Luxe Bidet HQ

7770 Regents Rd. 113-632

San Diego, CA 92122

United States