

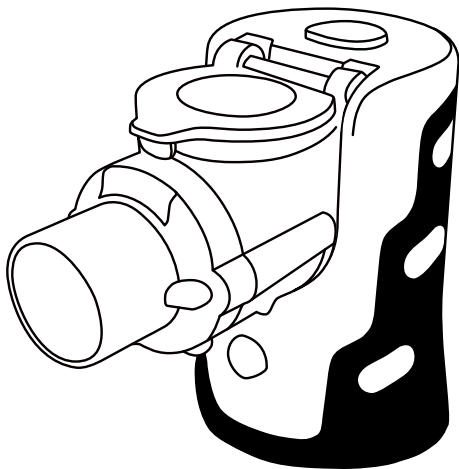

Instruction Manual

Mini Mesh Nebulizer

NEB400



Rx only

Table of Contents

1. Before Using the Device

1.1 Introduction and Warranty	1
1.2 Contents of the Mini Mesh Nebulizer Package.....	2
1.3 Intended Use	3
1.4 Safety Precautions	4
1.5 Classification and Explanation of Symbols.....	6
1.6 Components.....	7

2. Correct Use of the Unit

2.1 Operating with Batteries or USB Cord.....	9
2.2 How to Insert or Replace the Batteries	11
2.3 How to Connect the Power Adapter to Nebulizer	13
2.4 How to Assemble the Unit and Fill the Medication Cup.....	15
2.5 How to Select the Nebulization Mode.....	17
2.6 How to Inhale with the Mini Mesh Nebulizer.....	17

3. Correct Cleaning and Disinfection Procedure

3.1 How to Clean the Unit after Each Use.....	19
3.2 How to Disinfect the Unit.....	21

4. Troubleshooting and Specifications

4.1 Troubleshooting.....	22
4.2 Technical Data.....	24
4.3 Electromagnetic Compatibility Data.....	28

1. Before Using the Device

1.1 Introduction

Thank you for purchasing the Sunset NEB400 Mini Mesh Nebulizer. Before using the nebulizer for the first time, please read the instructions thoroughly and use it correctly. To further understand the device and suitable medications, please be sure to follow a doctor's instruction. Additional questions can be directly addressed to your place of purchase/local supplier. The Mini Mesh Nebulizer can be powered by two AA alkaline batteries or USB cord.

Caution: Federal law restricts this device to sale by or on the order of a physician

ONE YEAR LIMITED WARRANTY

Sunset Healthcare Solutions offers a limited 1-year warranty on the Mini Mesh Nebulizer unit to be free from defects in material and workmanship under normal use and operation for a period of 1 year from date of original retail purchase. This warranty does not extend to failures resulting from accidental damage, misuse, negligence, abuse, alteration, or improper operation. This warranty does not extend to non-durable components which are subject to normal wear and need periodic replacement nor does this warranty extend to hospital or clinic use. All items returned must be properly packaged and shipped in a manner to avoid shipping damage at the purchaser's expense.

DO NOT return any product(s) or part(s) to Sunset Healthcare Solutions without prior consent. For replacement under warranty, please call: 1-877-578-6738 (Monday to Friday, 9 am to 5 pm CST).

1.2 Contents of the Mini Mesh Nebulizer Package

Check before use

The following items are contained in the package. Please check all parts for visible damage. Replace any damaged parts before use. In the case of missing parts, malfunction, or damage, please contact your local dealer/place of purchase.



1. Main unit

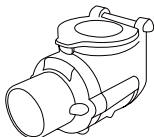

2. Medication cup
NEB400-CUP



3. USB cord

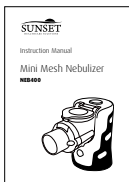

4. Instruction manual

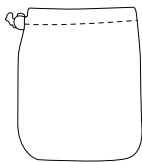

5. Bag

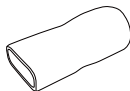

6. Mouthpiece
NEB400-MP

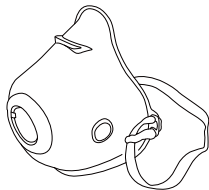

7. Adult mask
NEB400-MASKA



8. Pediatric mask
NEB400-MASKP

**Please replace parts in the following situations:

- After using the main unit for 2 years.
- After using the medication cup for 1 year.

Medication cup should be inspected after each cleaning for physical damage, cracks or leaks.

If medicine cup is not in good condition after inspection or takes longer than 10 minutes to deliver 2mL of medication, it should be replaced.

Note

To order replacement part (medication cup) or accessories, please contact your local supplier.

Information regarding serial number can be obtained by reading or scanning QR code on the main unit.



Warning

Do not use the device where it may be exposed to flammable gas.

1.3 Intended Use

The Mini Mesh Nebulizer is an ultrasonic vibrating mesh nebulizer system designed to aerosolize physician-prescribed liquid medications for inhalation to a patient except for Pentamidine. The device may be used with patients 5 years and older in the home, hospital, and sub-acute care settings.

1.4 Safety Precautions

To ensure safe and effective use of the nebulizer, please read the instruction manual carefully before using.



WARNINGS

- The nebulizer is intended for aerosolizing respiratory medication and only doctor's prescribed medication can be used. The manufacturer cannot be held liable for any damage caused by improper or incorrect use.
- To reduce the spread of infectious diseases, **do not** share the nebulizer, it is intended to be used by a single user.
- Device needs to be cleaned and disinfected in accordance with the user manual to avoid possible contamination.
- **Do not** operate the device if any of the parts are damaged or a fault is suspected.
- **Do not** connect nebulizer with other medical ventilation systems to avoid possible damage.
- Adult supervision is required when device is used by children and individuals who require special assistance.
- **Do not** remove medication cup during nebulization to avoid possible electrical shock by accidentally contacting the electrodes.
- **Do not** connect the adapter to the AC outlet under the following circumstances to avoid possible electrical shock:
 - when malfunction occurs during operation
 - when cleaning and disinfecting the device
 - when nebulizer is not used
- **Do not** expose the main unit or adapter to water in order to avoid malfunction or electrical shock.
- **Do not** pull the cable of power adapter for disconnecting from the AC outlet.

CAUTIONS

- Clean the nebulizer before first use, after each use and after extended storage to avoid unwanted contamination.
- Clean and disinfect the mesh in accordance with the user manual to avoid possible damage.
- Operational temperature should be kept within 10 ~ 40°C / 50 ~ 104°F to avoid damaging the device.
- Storage temperature should be kept within -20 ~ 70°C / -68 ~ 158°F to avoid damaging the device.
- **Do not** drop the device to avoid potential malfunction.
- **Do not** poke mesh module. The device may be broken.
- **Do not** modify the device in any way to avoid potential damage.
- The device is MRI unsafe, **do not** use in an MRI environment.
- Interference may occur in the vicinity of equipment with this mark: 
- **Do not** use close to strong electrical or electromagnetic fields. This may result in incorrect operation and create a potentially unsafe condition.
- **Do not** turn on the nebulizer when medication cup is empty.









Anti-theft systems and Radio Frequency Identification (RFID) readers are used in a wide variety of settings, including supermarkets, shopping malls, libraries and hospitals. Metal detectors for airport and facility security applications can either be portals that a person walks through, or can be hand-held “wands” that are passed over a person’s body.

Exposure to these systems can result in the device turning off automatically. If this occurs, move away from the system, turn the device off, remove batteries, insert again and then turn on. Normal operation should resume.

Patients should take the following precautions:

- Be aware that anti-theft systems and RFID readers in many commercial establishments can be hidden or camouflaged in entrances and exits where they are not readily visible.
- Do not stay near the anti-theft system, RFID reader or metal detector longer than is necessary and do not lean against them.
- If you are scanned with a hand-held metal detector, advise the security personnel that you have an electronic medical device and ask them not to hold the metal detector near the device any longer than is absolutely necessary; or, request an alternate form of personal search.

1.5 Classification and Explanation of Symbols

Symbols	Meaning
	Caution or Warning, consult accompanying documents
	BF type is a degree of protection against electrical shock (applied part).
IP22	Protects against solid foreign objects that are ≥ 12.5 mm in diameter and drops of water falling at up to 15° from the vertical.
	Read the instruction manual carefully.
	Serial number
	Catalog number
	Disposal of Electrical & Electronic Equipment (WEEE): Do not treat this product as household waste.
	Date of manufacture
	Name and address of manufacturer
	Unsafe for use with magnetic resonance imaging

1.6 Components

Medication Cup

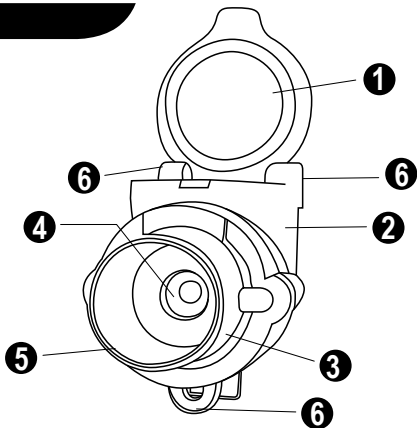

1. Medication cup cap

To be opened when filling the medication or cleaning the cup.

2. Cup

Prescribed nebulizer medication can be filled here by opening the cap (8 ml/cc).

3. Mouthpiece

To be placed between teeth with lips firmly sealed around it, and to facilitate inhalation of aerosolized medication.

4. Nebulizing mesh

The module oscillates at high frequency and pushes the medication through the apertures on mesh.

⚠ Do not touch this portion with your fingers or other foreign objects.

⚠ Do not attempt to clean with a cotton swab or a pin.

5. Nebulization port

Nebulized medication exits here.

6. Medication cup lock

Medication cup is securely locked into the main unit before nebulization.

Main Unit

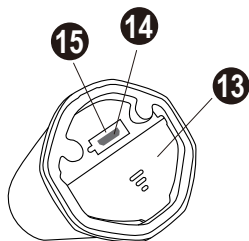
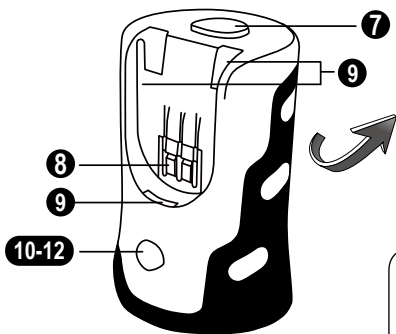

Bottom side



Press Release Button to remove the medication cup.

7. ON/OFF button

8. Electrodes

Connects the main unit with the nebulizing mesh on medication cup.

9. Inner latch

Medication cup is securely installed onto the main unit before nebulization.

10. Power indicator

A green light turns on when the power is on.

11. Low power/malfunction indicator

An orange light blinks when the batteries are low. No light indicates malfunction.

12. Medication cup release button

Medication cup can be removed when the button is pushed.

13. Battery cover

14. USB power socket

15. USB power socket cover

2. Correct Use of the Unit

2.1 Using the Nebulizer with Batteries or USB Cord

Battery Power

Step 1. Check the parts

(Refer to Chapter 1.2)

Step 2. Clean and disinfect the medication cup when using the nebulizer for the first time

(Refer to Chapter 3)

Step 3. Insert batteries

(Refer to Chapter 2.2)

Step 4. Assemble the main unit and medication cup

(Refer to Chapter 2.4)

Step 5. Fill the cup with medication

(Refer to Chapter 2.4)

Step 6. Press power button to turn on

Step 7. Inhale the aerosolized medication

(Refer to Chapter 2.6)

Step 8. Press power button to turn off

(Refer to Chapter 2.6)

Step 9. Clean the unit **and disinfect** the medication cup

(Refer to Chapter 3)

USB Power

- Step 1. Check** the parts
(Refer to Chapter 1.2)
- Step 2. Clean and disinfect** the medication cup when using the nebulizer for the first time
(Refer to Chapter 3)
- Step 3. Assemble** the main unit and medication cup
(Refer to Chapter 2.4)
- Step 4. Fill** cup with medication
(Refer to Chapter 2.4)
- Step 5. Connect the USB cord to nebulizer and power source**
(Refer to Chapter 2.3)
- Step 6. Press** power button on
- Step 7. Inhale** the aerosolized medication
(Refer to Chapter 2.6)
- Step 8. Press** power button off
- Step 9. Clean** the unit **and disinfect** the medication cup
(Refer to Chapter 3)

2.2 How to Insert or Replace the Batteries

Before assembling the unit and filling the medication cup.

Inserting Batteries

1. Turn the unit upside down.

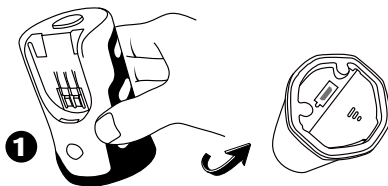

2. Remove the battery cover by sliding in the direction of the arrow.

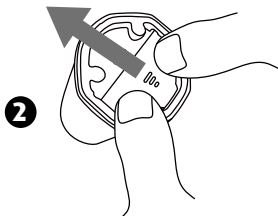

3. Insert batteries (not included) according to the battery polarity shown inside.

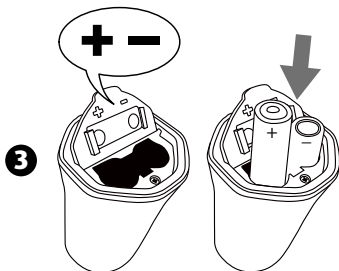

4. Slide back the battery cover into original position (in the direction of the arrow) to complete replacement.

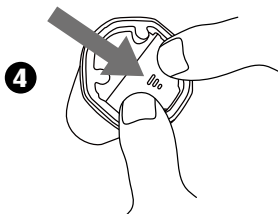

- Battery life depends on capacity and condition of the batteries.
- In general, device can operate approximately 4 days with new batteries, based on a usage of a 20-minute daily treatment, or 90 continuous minutes.

⚠ Warning

Batteries must be removed if the unit is not in use for extended period. Failure to do so may result in damage due to battery leak.

Note

1. A constant green light indicates proper function.
2. Low battery power is indicated by flashing orange light. Replace both batteries with new ones
3. No light indicates malfunction. Please contact local dealer/place of purchase.

⚠ Warning

- **Do not touch electrodes to avoid possible electrical shock**

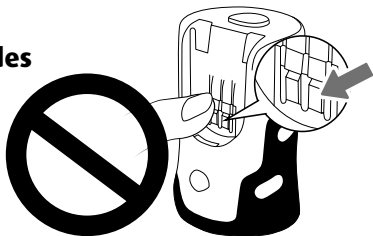

2.3 How to Connect Power Adapter to Nebulizer

When Using USB

(After filling the cup with medication)

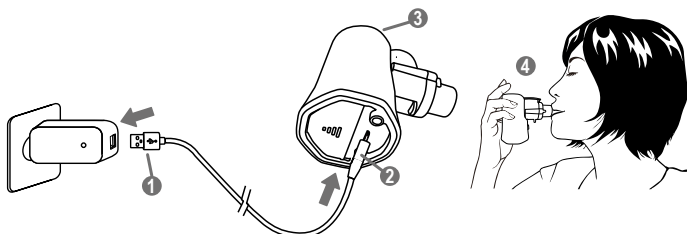

Remove batteries before using nebulizer with USB cord.

1. Insert the large USB cable end into a USB power source.
2. Remove USB power socket cover on the bottom of the main unit and insert the small USB cable end into the USB socket.
3. Turn power on.
4. Inhale. (Please refer to Chapter 2.6 for detailed information)

Please note that the USB cord powers the device, but does not charge the batteries.

2.4 How to Assemble the Unit and Fill the Medication Cup



Caution

- When using the device for the first time, or after daily use, or after not using it for an extended period of time, clean and disinfect the medication cup. Refer to Chapter 3.1 for instructions.
- Make sure the power is turned off before filling medication.

1. Assemble the medication cup:

Assemble the device by firmly attaching the medication cup to the main unit, making sure the **three locks** are aligned with the inner latches.

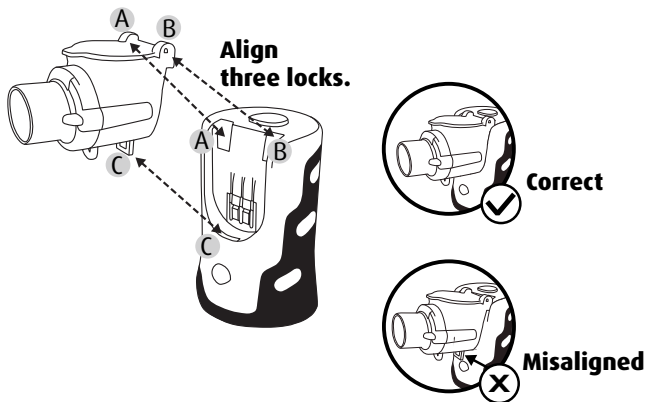

2. Open the medication cup cover.

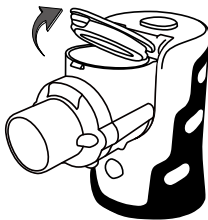

3. Fill in the prescribed medication as illustrated.

The maximum capacity is 8 ml/cc.

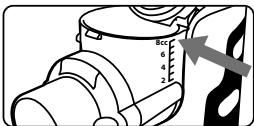
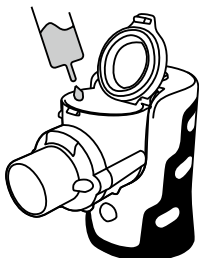

**! DO NOT EXCEED THE LIMIT.
(Max. 8ml/cc).**

4. Carefully replace the cover until it is firmly sealed with a “click” sound.

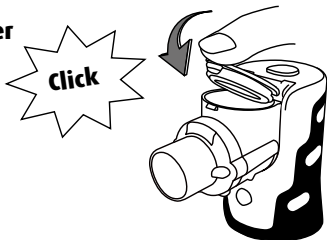

5. The device is now ready for use. Refer to the next page for instructions on how to select nebulization mode and inhale with the nebulizer.

Note

If high-viscosity solution is used, nebulization rate may be reduced.

2.5 How to Select the Nebulization Mode

- By quickly pressing the ON/OFF button once (), the device will nebulize continuously for 30 minutes prior to automatic stopping.
- If the ON/OFF button is pressed again during nebulization, the nebulizer will turn off.
- Green indicator lights up during proper nebulization.

2.6 How to Inhale with the Nebulizer

Warning

Warning: For type, dose, and regimen of medication follow the instructions of your physician or licensed healthcare practitioner.

1. Hold the device in the upright position as illustrated in the figure below. In this position, the nebulizing mesh is completely immersed in medication and able to become aerosolized when power is turned on.

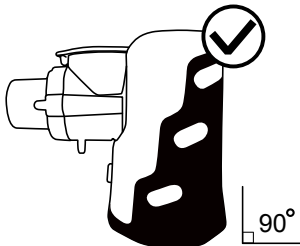

Upright Position

Caution

In some positions (e.g. tilting backward), nebulization may stop after a while. Re-adjust to upright position in order to re-immers the nebulizing mesh with medication.

Tilting Backward

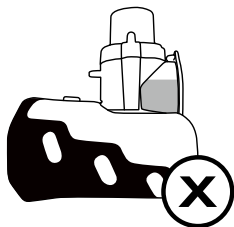

2. Gently position the mouthpiece between teeth with lips firmly sealed around it. Be calm and relaxed when inhaling and exhaling through mouth. Breathe in slowly and deeply to allow proper deposition of aerosol in airway.



3. After completing the therapy, press ON/OFF button to turn off the device.

Caution

1. If excessive medication builds up on the mesh, nebulization performance may be impaired. Turn off the device and remove the fluid. Please see Chapter 3.1
2. Do not poke the mesh as it may be permanently damaged.

3. Correct Cleaning and Disinfection Procedure

3.1 How to Clean the Unit after Each Use

Warning

- Without correct and frequent cleaning and disinfection, micro-organisms may build up in the unit and cause potential infection.
- **Medication cup should be cleaned after each use.**

Caution

- Keep the battery and power adapter compartment dry at all times.

1. Remove the medication cup from the main unit by pushing medication cup release button and gently pulling up in the direction of the arrow.
2. Open the medication cup cap, empty medication, discard remaining solution and then close cap.
3. Fill the medication cup with distilled water and nebulize 1-2 minutes to remove any residual medication in the mesh holes. Visually inspect the mesh holes immediately.
4. Turn off the device and remove the power source.
5. Remove the medication cup from the main unit.
6. Thoroughly rinse the medication cup (both inside and outside), mesh and mouthpiece with distilled water. Appropriately, scrub the cup and mouthpiece by fingers with distilled water.
7. Air dry the medication cup, mesh and mouthpiece or use a clean cloth or paper towel.

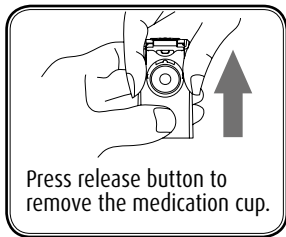

Warning

- Do NOT rinse or immerse the main unit into any kind of liquid.
- Make sure the electrodes are dried.
- Do NOT poke the mesh with finger, cotton swab or any objects.

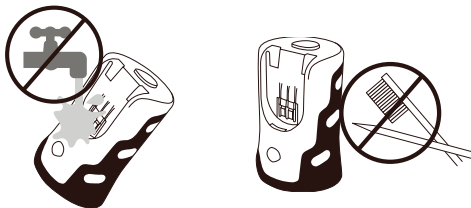

8. Make sure that all cleaned parts are completely dried before installation.
9. Clean the main unit and the electrodes by wiping it off with (moistened) gauze. Use dry gauze to wipe the main unit.

Caution

- Do not use volatile agents such as benzene or alcohol or thinner.
 - Do NOT clean parts in a dishwasher.
 - Do NOT use microwave to dry any parts.
10. Visually inspect the parts after cleaning for any soiling or build-up. If there is any, repeat the cleaning steps.
 11. Assemble the device by following instructions shown Chapter 2.
 12. Store the device in a dry, clean place.

3.2 How to Disinfect the Unit

Caution

Without correct and frequent cleaning and disinfection, micro-organisms may build up in the unit and cause potential infection.

When to disinfect the unit

The medication cup, mesh and mouthpiece should be disinfected:

- Before using the device for the first time
- After the unit has not been used for more than a week
- Twice a week during normal use

1. Before disinfection, clean the device by adhering to the protocol shown in Chapter 3.1
2. Bring a large pot of water to a boil and turn off heat. Place medication cup in boiled water for 10 minutes to disinfect.

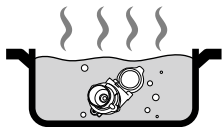

Medication cup

 **Do NOT put main unit in boiled water.**



 **Caution** Be careful of boiled water to avoid being scalded during disinfection process.

3. Remove medication cup from boiled water to lower device temperature.
4. Shake off excess water and air dry on clean cloth or paper towel.
5. Visually inspect the parts after cleaning for any visual soiling or build-up.
If there is any, repeat the cleaning steps.
6. Store the device in a dry, clean place.

4. Troubleshooting

4.1 Troubleshooting

Problem	Possible Causes	Corrective Actions
Slow nebulization	Batteries are low.	Replace with new batteries. (Please see Chapter 2.2)
	The holes on the mesh are stained or clogged.	Clean mesh by immersing in hot boiled water. (Please see Chapter 3.2)
	The mesh is broken.	Contact the nearest dealer.
	Improper connection between medication cup and main unit due to the stained/ wet electrodes.	Clean the electrodes by wiping it off with (moistened) gauze and air dry.
Green light fails to turn on and device fails to nebulize when the power is on.	The batteries are inserted in the wrong orientation.	Re-insert batteries in accord to the polarity sign. (Please see Chapter 2.2)
	Batteries are low or dead.	Replace with new batteries. (Please see Chapter 2.2)
	Battery cover is incompletely closed.	Make sure battery cover is completely sealed.
	Improper connection between adapter and main unit.	Check and reconnect the adapter to then main unit.

Problem	Possible Causes	Corrective Actions
The device fails to nebulize when the power and green light are on.	The medication cup is incorrectly installed.	Re-install the medication cup on main unit. (Please see Chapter2.4)
	The holes on the mesh are stained or clogged.	Clean medicine cup by immersing in hot boiled water. (Please see Chapter3.2)
	The mesh is broken.	Contact your place of purchase.
	Nebulizing mesh is not completely immersed in medication.	Re-adjust device to upright position and re-immerses the nebulizing mesh in medication. (Please see Chapter2.6)
	The medication cup is partially or not filled with medication.	Make sure enough medication is filled in the medication cup. (Please see Chapter2.4)
	Excessive medication builds up on the mesh.	Remove excessive medication. (Please see Chapter3.1)
Orange light turns on continuously.	Batteries are low or dead.	Replace with new batteries. (Please see Chapter2.2)
Orange light flashes then device turns off automatically.	Improper connection between medication cup and main unit due to the stained/ wet electrodes.	Clean the electrodes by wiping it off with (moistened) gauze and air dry.
	Batteries are dead.	Replace with new batteries. (Please see Chapter2.2)
	The mesh is broken.	Contact your place of purchase
	The medication cup is incorrectly installed.	Re-install the medication cup on main unit. (Please see Chapter2.4)

4.2 Technical Data

Product	Mini Mesh Nebulizer
Model	NEB400
Working Technology	Active Vibrating Mesh Technology
Vibrating Frequency	Approx. 117kHz±15%
Power Source	AA Alkaline battery × 2 USB 5V 1A
Power Consumption	< 1.5 W
Nebulization Rate	≥0.25 ml/min
Particle Size	Approx. 5µm (MMAD)

Capacity of Medication Cup	Approx. 8 ml
Dimension	Approx. L78 X W41 X H73 mm
Weight	Approx. 74g (Excluding batteries)
Operation Temperature and Humidity Range	10~40°C/50-104°F, 30-85% RH 800hPa - 1060hPa
Storage and Delivery Temperature and Humidity Range	-20-70°C/-68-158°F, 20-75% RH 800hPa - 1060hPa
Ingress Protection	IP22

The following specifications were established via performance tests using an eight-stage cascade impactor at a flow rate of 28 L/min equipped with a USP <601> induction port throat. Three (3) device samples were tested with 3 runs each, for a total of 9 sample points per each drug for a total of 27 data points. Aerosol was sampled directly from the outlet.

The specifications are listed below with intervals given for a 95% confidence level:

Table 1 – Aerosol-Only Mode at 28 Lpm and 12 Lpm - Particle Specifications w/ 95% Confidence Level

Features	Drugs	Proposed Mini Mesh Nebulizer	
		@ 28 L/min	@ 12 L/min
Total Dose (µg)	Albuterol Ipratropium Cromolyn Sodium	1719-2082 347-403 13372-14329	2159-2592 429-505 17733-18426
Particle size (MMAD) (Microns)	Albuterol Ipratropium Cromolyn Sodium	1.9-2.8 2.0-2.7 2.1-2.8	3.31-4.95 4.34-5.72 3.68-5.38
Geometric Std.Dev. (GSD)	Albuterol Ipratropium Cromolyn Sodium	1.9-2.6 2.1-2.6 2.3-2.8	2.03-2.72 2.39-3.50 2.56-2.89
Total Respirable Dose (0.5-5 micron)	Albuterol Ipratropium Cromolyn Sodium	1274-1487 237-275 8645-9954	1071-1596 198-219 7925-10601

Features	Drugs	Proposed Mini Mesh Nebulizer	
		@ 28 L/min	@ 12 L/min
Coarse Particle Dose (>4.7 micron) Albuterol	Albuterol Ipratropium Cromolyn Sodium	279-726 85-138 3723-4676	913-1214 213-291 7240-10277
Fine Particle Dose (<4.7 micron)	Albuterol Ipratropium Cromolyn Sodium	1290-1506 241-286 8995-10307	1026-1597 212-218 8135-10507
Ultra-fine Particle Dose (<1 micron)	Albuterol Ipratropium Cromolyn Sodium	215-354 49-68 1524-2736	31-220 14-44 887-1904
Confidence Level of Testing	Albuterol Ipratropium Cromolyn Sodium	The test and number of samples tested provided a 95% confidence level.	
NOTE: Course particles (oro-pharyngeal deposition) and ultra-fine particles (exhaled) are not likely to deposit in the patient's airway and thus provide limited clinical benefit.			

4.3 Electromagnetic Compatibility Data

Caution

Medical electrical equipment requires special precautions regarding electromagnetic compatibility (EMC) and needs to be installed and put into service according to the EMC information provided in this document and the remainder of the instructions for use of this device.

Portable and mobile RF communications equipment can affect medical electrical equipment.

Cables and accessories not specified within the instructions for use are not authorized. Using other cables and/or accessories may adversely impact safety, performance and electromagnetic compatibility (increased emission and decreased immunity).

Care should be taken if the equipment is used adjacent to or stacked with other equipment; if adjacent or stacked use is inevitable, the equipment should be observed to verify normal operation in the configuration in which it will be used.

Guidance and manufacturer's declaration of electromagnetic immunity

The NEB400 will continue to operate normally throughout the immunity testing below. The customer or the user of the NEB400 should assure that it is used in such an environment.

Immunity Test	IEC 60601-1-2 Test Level	Compliance Level	Guidance
Electro-Static Discharge (IEC 61000-4-2)	±6 kV contact ±8 kV air	±8 kV contact ±5 kV air	The relative humidity should be at least 5 %
Electrical fast transient/burst Immunity (IEC 61000-4-4)	±2 kV power supply lines	±2 kV power supply lines	Mains power quality should be that of a typical home commercial or hospital environment
Surge Immunity (IEC 61000-4-5)	± 2 kV line to line	±0.5, 1.0 and 2 kV line to line Class II device so line to earth NA	Mains power quality should be that of a typical home commercial or hospital environment.
Power frequency (50/60 Hz) magnetic field Immunity (IEC 61000-4-8)	3 A/m; 50 and 60 Hz	30 A/m; 50 and 60 Hz	Power frequency magnetic fields from common appliances in the home are not expected to affect the device. Power frequency magnetic fields should be at levels characteristic of a typical location in a typical commercial or hospital environment. Keep the device away from sources of high levels of power line magnetic fields (in excess of 30 A/m) to reduce the likelihood of interference.
Voltage interruptions (IEC 61000-4-11)	<5 % UT (>95 % dip in UT) for 0,5 cycle 40 % UT (60 % dip in UT) for 5 cycles 70 % UT (30 % dip in UT) for 25 cycles <5 % UT (>95 % dip in UT) for 5 s	<5 % UT (>95 % dip in UT) for 0,5 cycle 40 % UT (60 % dip in UT) for 5 cycles 70 % UT (30 % dip in UT) for 25 cycles <5 % UT (>95 % dip in UT) for 5 s	Mains power quality should be that of a typical home commercial or hospital environment. If the user requires continued operation during power mains interruptions beyond that provided by the battery, it is recommended that it be powered from an uninterruptible power supply.

In order to regulate the requirements for EMC with the aim to prevent unsafe product situations, the IEC 60601-1-2 standard has been implemented. The nebulizer NEB400 conforms to the IEC 60601-1-2:2014 standard for both immunity and emissions.

Nevertheless, do not use the nebulizer close to the strong electrical or electromagnetic fields. This may result in incorrect operation and create a potentially unsafe situation.

Guidance and manufacturer's declaration - of NEB400.

Guidance and manufacturer's declaration-electromagnetic emissions		
The NEB400 is intended for use in the electromagnetic environment specified below. The customer or the user of the NEB400 should assure that it is used in such an environment.		
Emission test	Compliance	Electromagnetic environment-guidance
RF emissions CISPR 11	Group 1	The NEB400 uses RF energy only for its internal function. Therefore, its RF emissions are very low and are not likely to cause any interference in nearby electronic equipment.
RF emissions CISPR 11	Class B	The NEB400 is suitable for use in all establishments, including domestic establishments and those directly connected to the public low-voltage power supply network that supplies buildings used for domestic purposes.
Harmonic emissions IEC 61000-3-2	Class A	
Voltage fluctuations /flicker emissions IEC 61000-3-3	Pass	

Recommended separation distances between portable and mobile RF communications equipment and the NEB400

The NEB400 is intended for use in an electromagnetic environment in which radiated RF disturbances are controlled. The customer or the user of the NEB400 can help prevent electromagnetic interference by maintaining a minimum distance between portable and mobile RF communications equipment (transmitters) and the NEB400 as recommended below, according to the maximum output power of the communications equipment.

Rated maximum output power of transmitter W	Separation distance according to frequency of transmitters in meters		
	150 kHz to 80 MHz $d = 1.2/\sqrt{P}$	80 MHz to 800 MHz $d = 0.35\sqrt{P}$	800 MHz to 2,5 GHz $d = 0.7\sqrt{P}$
0.01	0.12	0.04	0.07
0.1	0.37	0.11	0.22
1	1.2	0.35	0.7
10	3.7	1.1	2.2
100	12	3.5	7.0

For transmitters rated at a maximum output power not listed above, the recommended separation distance d in meters (m) can be estimated using the equation applicable to the frequency of the transmitter, where P is the maximum output power rating of the transmitter in watts (W) according to the transmitter manufacturer.

NOTE 1 At 80 MHz and 800 MHz, the separation distance for the higher frequency range applies.

NOTE 2 These guidelines may not apply in all situations. Electromagnetic propagation is affected by absorption and reflection from structures, objects and people.

Electromagnetic Compatibility Data

This equipment is intended for use in the electromagnetic environment specified below. The user should ensure that it is used in such an environment.

Immunity test	IEC 60601 test level	Compliance level	Electromagnetic environment-guidance
Conducted RF rf coupled into lines (IEC 61000-4-6)	3 V rms 150 kHz to 80 MHz outside ISM bands 80MHz to 2.5GHz 6 VRMS 150 kHz to 80 MHz inside ISM bands	3 Vrms 6 Vrms	Portable and mobile RF communications equipment should be used no closer to any part of the unit, including cables, than the recommended separation distance calculated from the equation applicable to the frequency of the transmitter as below. Recommended separation distance $d=1.2\sqrt{P}$ $d=0.58/\sqrt{P}$ 80 MHz to 800 MHz
Radiated rf (IEC 61000-4-3)	3 V/m 80 MHz – 2.7 GHz	10 V/m	$d=0.35\sqrt{P}$ 800 MHz to 2.5 GHz where P is the maximum output power rating of the transmitter in watts (W) according to the transmitter manufacturer and d is the recommended separation distance in metres (m). Field strengths from fixed RF transmitters, as determined by an electromagnetic site survey ^a , should be less than the compliance level in each frequency range ^b . Interference may occur in the vicinity of equipment marked with the following symbol: 

NOTE 1: At 80 MHz and 800 MHz, the higher frequency range applies.

NOTE 2: These guidelines may not apply in all situations. Electromagnetic propagation is affected by absorption and reflection from structures, objects and people.



WEEE (Directive on Wasted Electrical and Electronic Equipment)

This marking shown on the product indicates that it should not be disposed of, with other household wastes, at the end of its working life. To prevent possible harm to the environment or human health from uncontrolled waste disposal, please separate this from other types of wastes and recycle it responsibly to promote the sustainable reuse of material resources.

Household users should contact either the retailer where they purchased this product, or consult their local recycling guidelines, for details of where and how they can take this equipment for safe recycling.

Manufactured for
Sunset Healthcare Solutions
180 N Michigan Ave Ste 2000
Chicago, IL 60601
www.sunsethcs.com

NEB400-IFU V1.00
2019-01-16