

Best Friend Mobility



USER'S MANUAL



Rear Support Wheelchair
For Sizes L/XL

TABLE OF CONTENTS

INTRODUCTION	1
PRODUCT INFORMATION	3
Measure Your Pet	3
ASSEMBLY	5
Breakdown of Pre-assembled Parts	7
Assembling the Wheelchair	9
WHEELCHAIR USE	16
Fitting Your Pet into the Wheelchair	18
Troubleshooting	23
CARE AND MAINTENANCE	25
CONTACT US	25

Best Friend Mobility® Rehabilitation Aids

Dear Pet Owner and Valued Customer:

The following guidelines, along with the attached assembly and fitting instructions, will help you get the best use of your dog wheelchair.

Please read and follow the Assembly instructions before making any attempt to place your pet in the wheelchair. Should you encounter any problems with assembly and fitting, please call Best Friend Mobility directly through our hotline **(843) 492-5283**.

If you think you need a different size, we can process the exchange for you easily. Just contact us at **support@dogwheelchairscenter.com** or call our hotline.

NOTE: With regard to the front harness, it is possible that your pet may need to go either one size bigger or smaller than you originally thought. If for some reason the front harness does not fit, please contact us immediately so we can send you the next size according to your pet's requirement.

If your pet is fully NON-weight-bearing on its hind legs, we recommend that you gradually condition your pet to wheelchair use before prolonged periods are attempted. It generally takes about two (2) weeks for your pet to develop satisfactory foreleg strength to compensate for the non-weight bearing state of the hind legs in the wheelchair.

We suggest that you start your pet on a 10-minute exercise regimen, walking over a hard surface. We advise using a leash that is attached either to your pet's collar or to the wheelchair's front harness. Repeat twice daily for the first few days then increase to thrice daily thereafter.

Once your pet adapts to the 10-minute exercise sessions, the length of time can be extended to match your pet's stamina. For pets that are coming back to walking on their own, we recommend daily use of their wheelchair in order to get sufficient exercise. Time on the wheelchair will NOT prevent them from walking, it will instead encourage them to do so and aid in their rehabilitation.

PETS SHOULD NEVER BE LEFT UNSUPERVISED IN THEIR WHEELCHAIRS.

This is a learning process and can take time. We realize that both you and your pet are most likely unfamiliar with the use of a dog wheelchair so do not hesitate to contact us for help. Please be advised that most dogs do not intuitively know how to use a wheelchair, they will require training and practice.



Some dogs may be afraid in the beginning so it is important to give positive reinforcement when placing them in the chair, especially for the first time.

Use treats. Treats held in front of your pet will encourage it to take steps and move forward; this will teach them to ambulate while in the chair. **It may take several training sessions before a dog is able to actually use the wheelchair. It is okay and normal if your dog does not take to it right away.**

It is very important, especially with skittish animals, that they come into physical contact with the wheelchair in some way every day. This should always be coupled with positive reinforcement like praise, pets, and treats. This will help to create a positive association with the wheelchair and help the animal to eventually to love the wheelchair and be able to learn to use it. This process may take from days to months, so please don't lose hope, persistence will pay off. Contact us for any help or questions.

Thank you for purchasing a Best Friend Mobility dog wheelchair. Again, we love receiving feedback, stories, photos, and videos of how your pets are doing in their wheelchairs. We can feature them on our site and share your pet's stories with other pet owners.

Sincerely,

Tim Cantrell

Vice President
Best Friend Mobility
Phone: 843.492.5283
Fax: 503.296.2865



PRODUCT INFORMATION

The Best Friend Mobility Rear Support Wheelchair is another way of saying we've got our four-legged friend's back. With a little help from their friends, our furry pals can do more than get by; they can continue to enjoy life.

Made from lightweight aluminum non-rust alloy with all terrain pneumatic wheels, this dog wheelchair also features padded shoulder support, double-thronged adjustable neoprene shoulder harness, and a built-in adjustable double rear padded harness. Both male and female dogs will have no trouble relieving themselves comfortably even while on their Rear Support pet wheelchair.

This Best Friend Mobility Rear Support wheelchair is made to fit dogs according to height. If you find that the wheelchair you received is too big or too small for your pet, again, please call us immediately so that we can make sure you have the correct size.

MEASURE YOUR PET

Measure your pet to confirm that you have the correct size Best Friend Mobility Rear Support Wheelchair for your pet.

The only information you truly need to get the right size is the measurement from the floor to your pet's back—at its hindquarters. It's that simple!

Depending on your pet's current capabilities and its willingness to cooperate, this can be a 1-person or 2-person job.

If your pet has very little or no rear-limb strength, one person can be the support while the other does the measuring.

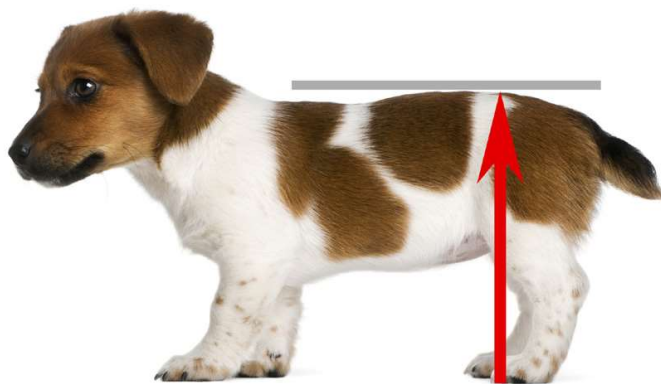

Depending on your pet's current capabilities and its willingness to cooperate, this can be a 1-person or 2-person job.

If your pet has very little or no rear-limb strength, one person can be the support while the other does the measuring.

REAR SUPPORT WHEELCHAIR SIZE CHART

2XS	8" - 11"	M	16" - 20"
XS	9" - 14"	L	20" - 26"
S	13" - 17"	XL	23" - 29"

Specifications:

- Lightweight, adjustable non-rust aluminum frame
- Stainless steel hardware
- Deluxe neoprene front and rear harness for complete comfort
- Designed and tested by a canine orthopaedic surgeon
- Easy hex wrench adjustment of height, length, and width
- Great for pets needing assisted walking or full weight support (zero weight-bearing) for hind legs
- Allows pets to go to the bathroom even while in the wheelchair
- All terrain polyurethane wheels with precision-sealed ball bearings
- Easy clip-on front harness system
- Durable and easy-to-clean rear harness

The Rear Support Wheelchair is good for:

- Hip Dysplasia
- Arthritis
- Neurological problems such as osteomyelitis or degenerative myelopathy
- Fracture of the spine/back
- Rear limb amputation
- Ligamentous injuries such as PCL or ACL
- Thoracic or lumbar disc injuries
- Rehabilitation
- Any other condition that results in rear leg or joint pain, or weakness and discomfort from any weight-bearing activities



ASSEMBLY

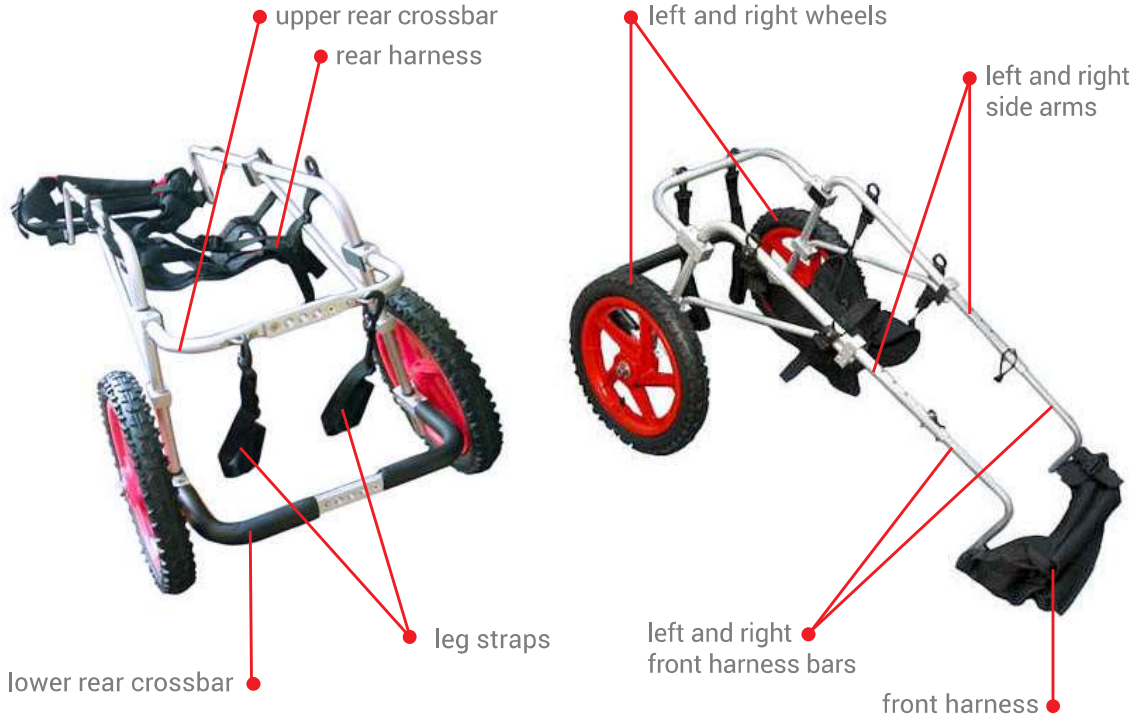

FRAME ASSEMBLY

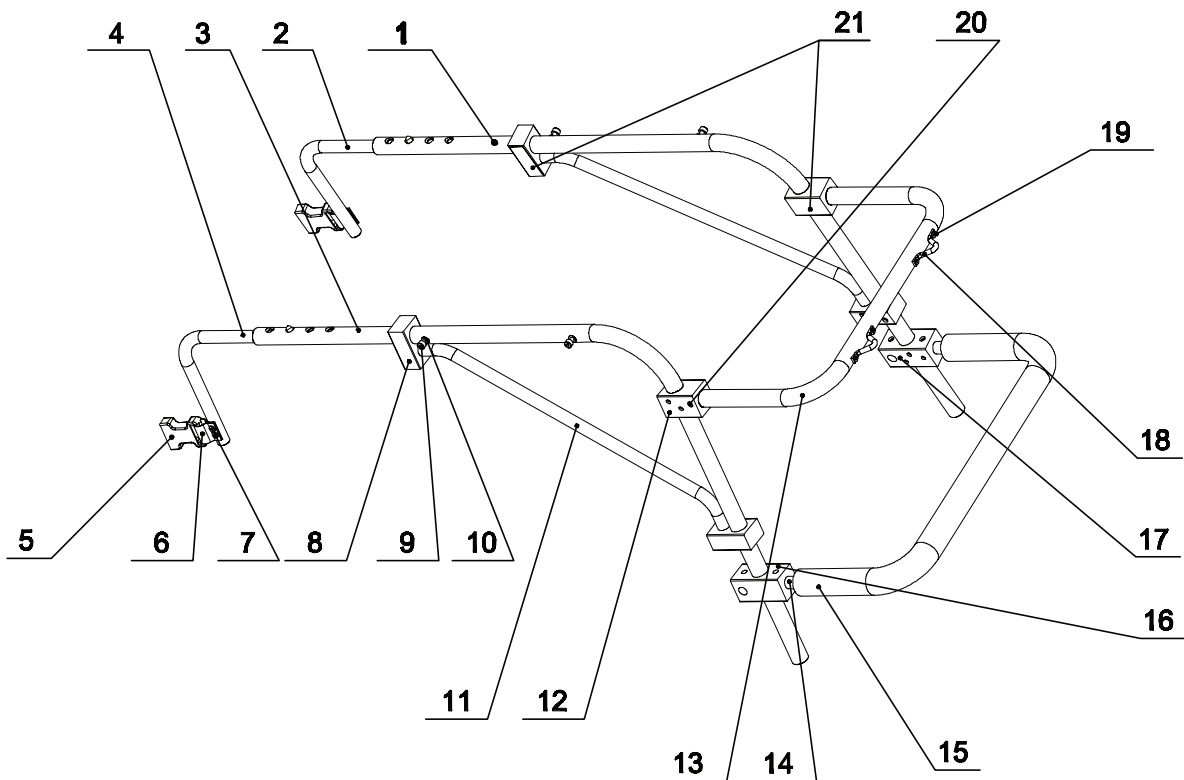

WHEEL ASSEMBLY

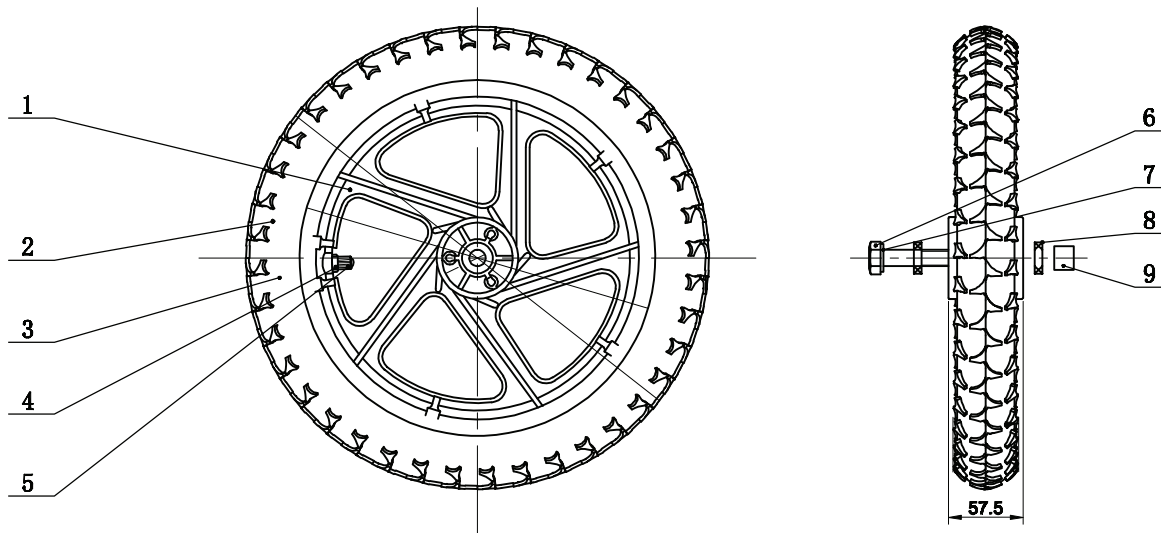

FRAME & WHEEL PARTS

FRAME PARTS:

1. DC01A Left Sidearm
2. DC02A Left Front Harness Bar
3. DC01B Right Sidearm
4. DC02B Right Front Harness Bar
5. Front Harness Female Clips
6. DC09 Clip Connectors
7. Clip Connector Screws
8. DC07 Frame Connectors
9. Sidearm Bolts
10. Washers
11. DC04 Frame Supports
12. DC08 Upper Crossbar Connectors
13. DC03 Upper Rear Crossbar
14. SFT Connector
15. DC05 Lower Rear Crossbar
16. DC06A Right Wheel Connector
17. DC06B Left Wheel Connector
18. DC10 Rear Harness Support

WHEEL PARTS:

1. Wheel
2. Treads
3. Tire
4. Valve
5. Valve Cap
6. Bolt Head
7. Wheel Bolt
8. Washer
9. Nut



Breakdown of Pre-Assembled Parts and Tools

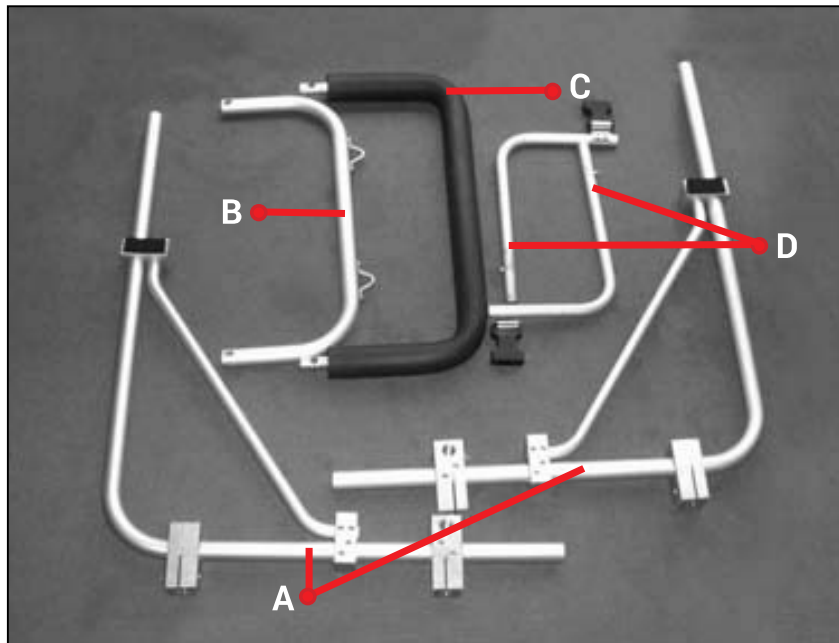

- A. Left and Right Side Arm Assembly
- B. Upper Rear Crossbar
- C. Lower Rear Crossbar
- D. Left and Right Front Harness Bar

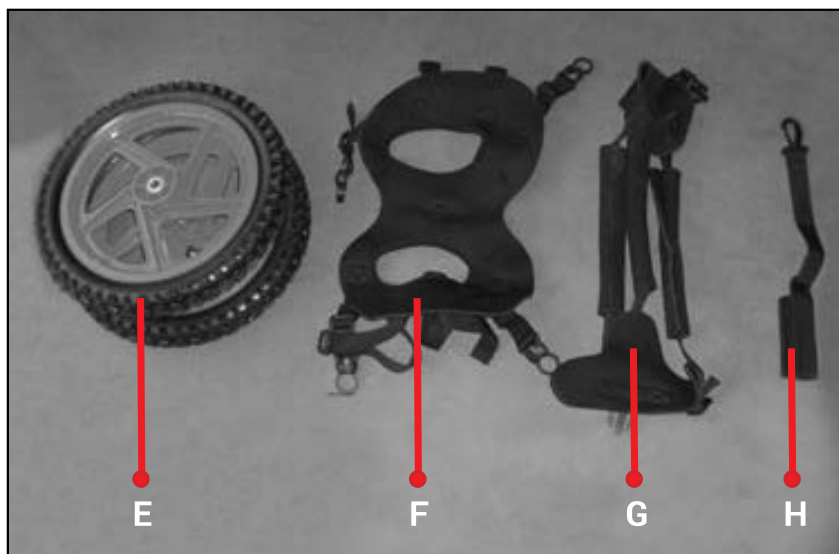

E

F

G

H



E. Left and Right Wheels

F. Comfort Rear Harness

G. Front Harness

H. Leg Straps

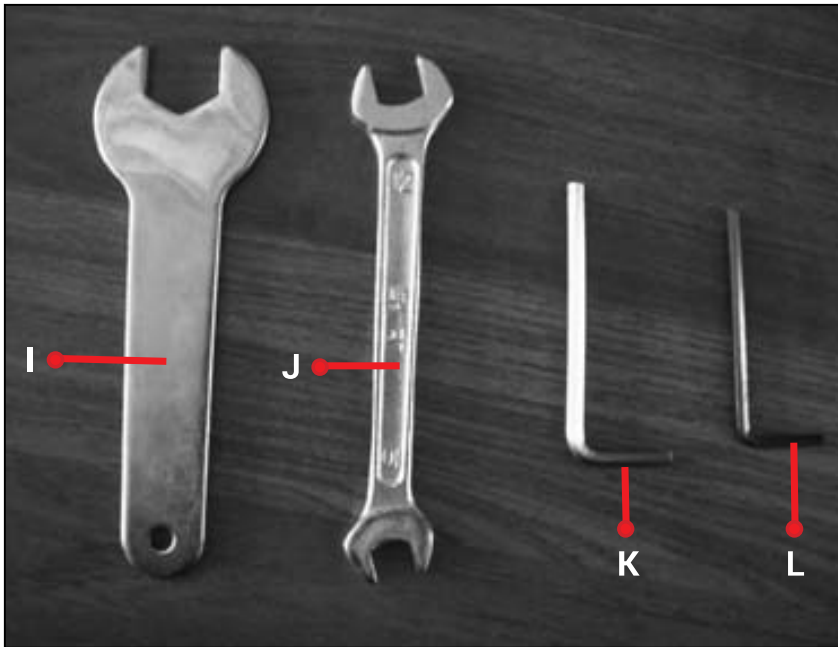

I. Big Open-End Wrench

J. Small Open-End Wrench

K. Big Hex Wrench

L. Small Hex Wrench



M. Sports Rear Harness

Assembling the Wheelchair

1. Connecting the upper rear crossbar (B) to the side arm assemblies (A)

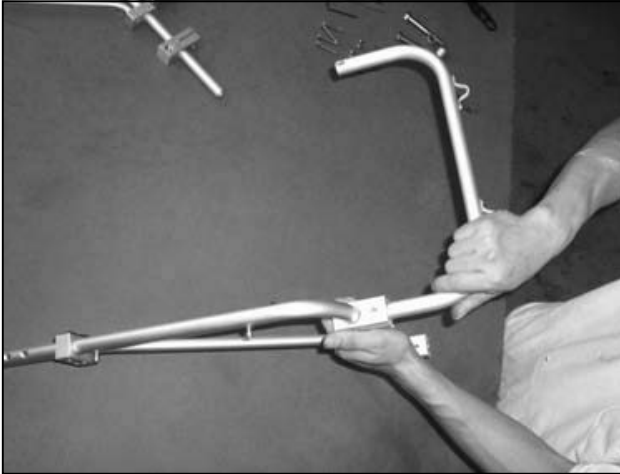

1.2 Fit the upper rear crossbar (B) to the left side arm assembly (A).



1.3 Place the connector block screw and the clip connector screw together inside the upper crossbar connector block.

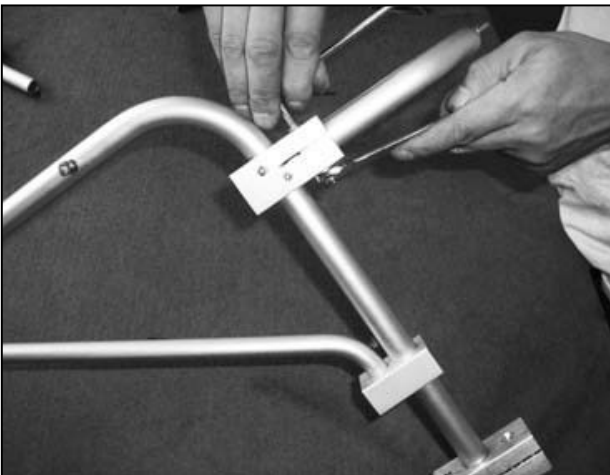

1.4 Hold the connector block screw steady with an open-end wrench while securing the clip connector screw with a hex wrench.



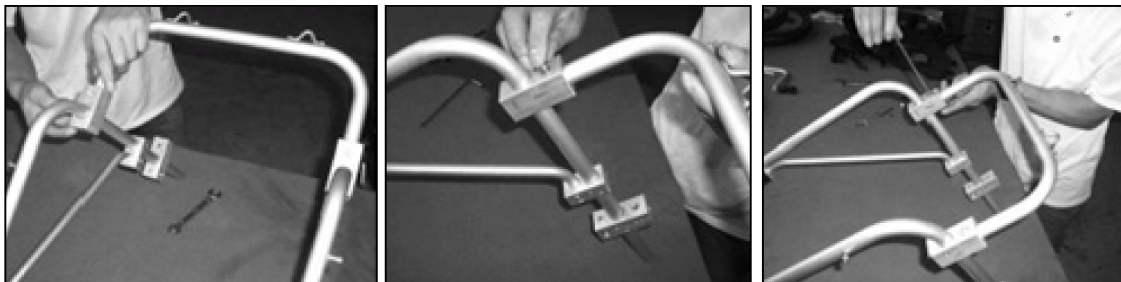

1.5 Repeat steps 1.1 to 1.3 to connect the upper rear crossbar to the right side arm assembly.

2. Connecting the lower rear crossbar (C) to the side arm assemblies (A)



2.1 Fit the lower rear crossbar (C) to the left and right side arm assemblies (A).

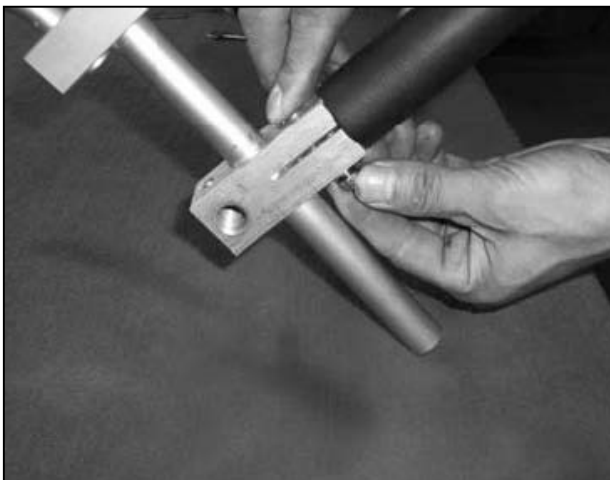

2.2 Place the connector block screw and the clip connector screw together inside the clip connector.



2.3 Hold the connector block screw steady with an open-end wrench while securing the clip connector screw with a hex wrench.

2.4 Using an open-end wrench and a hex wrench, tighten connector block screws for upper rear crossbar (B) and lower rear crossbar (C) to secure connection to the side arm assemblies (A).

3. Installing the left and right front harness bars (D)



3.1 Insert the left front harness bar (D) to the left side arm (A).

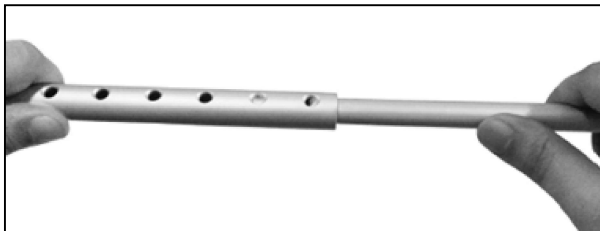

3.2 Adjust to desired length. Make sure the holes on the left front harness bar (D) are aligned with the holes on the left side arm assembly (A).

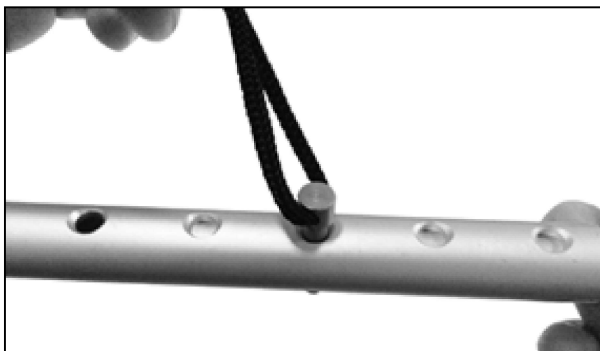

3.3 Insert metal lock in aligned hole until it comes out the other side.

3.4 Repeat 3.1 to 3.3 to install the right front harness bar (D) to the right side arm assembly (A).

Your progress so far

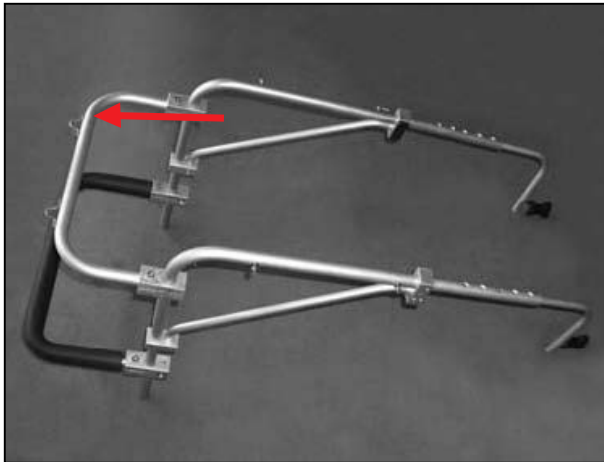

Figure 1

Please note that the upper rear crossbar is shorter than the lower rear crossbar; this makes the lower portion of the cart wider than the top.

4. Attaching the left and right wheels (E)



4.1 Use the big open-end wrench (I) to unscrew the wheel bolt from the right wheel connector found on the lower right arm assembly (A).



4.2 Insert a metal washer thru the bolt then insert thru the wheel hole. Insert another metal washer thru the bolt on the other side of the wheel.

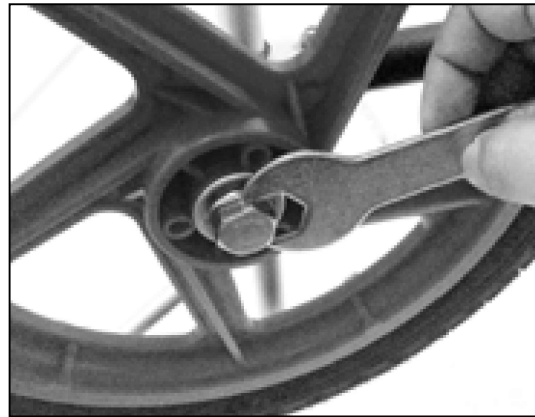
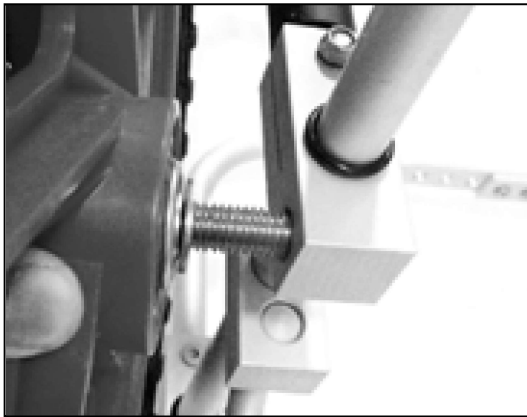

4.3 Screw the bolt back to the right wheel connector on the right side arm assembly (A). Tighten using the big open-end wrench (I).

4.4 Inflate wheels to recommended 35 psi, if necessary, with any standard pump.

5. Connecting the rear harness (F)

IMPORTANT NOTE: Start with the sports harness first. Do NOT use the comfort harness until after sports harness has been mastered.

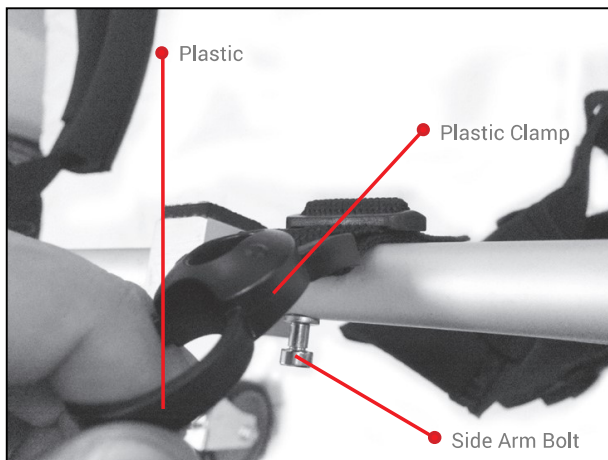

5.1 Align each plastic O-connector clamp near a corresponding side arm bolt. Holding it by the plastic ring, position strap with O-connector clamp to go up and over the side arm assembly.

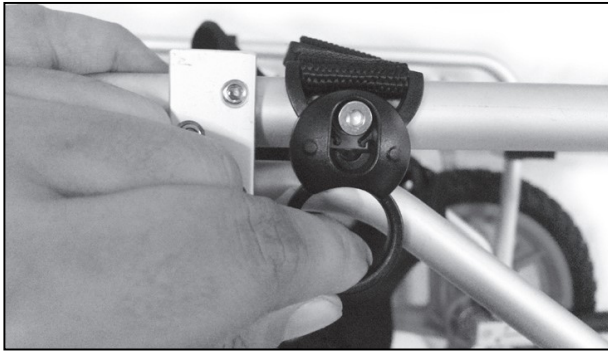

5.2 Fasten O-connector clamp to the side arm bolt by pushing it upward.

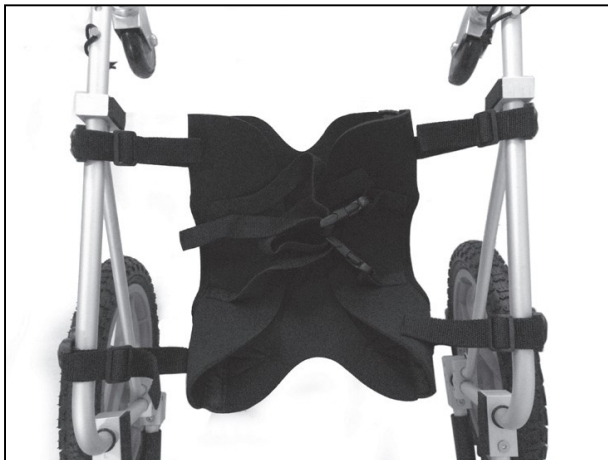

5.3 Repeat steps 5.1 to 5.2 to connect the remaining clamps.



5.4 Adjust the rear harness straps to a comfortable weight-bearing position for your pet. Make it longer or shorter using the adjuster buckle.

6. Attaching the front harness (G)



6.1 Attach the front harness (G) to the front harness bar simply by connecting the side release buckles.

6.2 Adjust front harness straps for snug yet comfortable fit using the adjuster buckle.

7. Attaching the leg straps (H)



7.1 Clip the leg straps (H) to the metal eyelets on the upper rear crossbar.

You are done with the assembly!



If your pet's hind legs are completely non-weight bearing and will need the use of the leg straps, the forelegs will require some conditioning time; it will need additional strength in order to compensate for weight the hind legs and for added comfort while in the Best Friend Mobility Rear Support Wheelchair. Please allow about two weeks for full strengthening of the forelegs before using the pet wheelchair for prolonged periods.

Again, to develop foreleg strength, we recommend 10-minute exercise sessions, with your pet walking over a hard surface. Begin with two 10-minute exercise sessions a day for the first few days and go up to three times daily afterwards. When your pet adapts to the 10-minute exercise sessions, you can extend the time to conform to your pet's stamina.

Is your pet too weak to stay on its forelegs while in the Best Friend Mobility Rear Support wheelchair due to being inactive or overweight? Attaching a leash on your pet's collar or to the wheelchair's front harness will help encourage your pet to walk or move and eventually work up to completing the conditioning regimen.

If your pet's forelegs do not display enough strength within a few weeks, it may need something other than what Best Friend Mobility wheelchair can provide. Observe if your pet is always trying to lie down or is still unable to hold its own weight after a couple of weeks. These are signs that its forelegs aren't strong enough—and not improving—to use a wheelchair.

Your pet may initially move backward instead of forward once in the Best Friend Mobility wheelchair. No need to worry. Your pet is "backing out" due to unfamiliarity. He or she will eventually settle down, become familiar and comfortable, and start moving forward with some assurance and encouragement.

Get your pet and its Best Friend Mobility wheelchair wet! Best Friend Mobility wheelchairs are made mostly of aluminum and will not rust. If the wheelchair is used at the beach and in salt water, just give it a thorough rinse to get the sand, salt water, and dirt off the moving parts; otherwise, getting the unit wet will not damage it.

If the wheel traction of your pet's wheelchair is poor, you may want to check the tire pressure. Remember to keep the pressure slightly below the required PSI. Make sure that the wheels can spin freely.



If the wheels track to one side more than the other, it may simply be due to how your pet naturally walks. You may notice your pet's gait more due to the new wheelchair, however, he or she will get used to the Rear Support wheelchair and be able to compensate in due time. Also, check both sides to make sure that your pet is centered on the wheelchair and adjust the straps if necessary.

DO NOT LEAVE YOUR PET ALONE IN THE CART!



FITTING YOUR PET INTO THE WHEELCHAIR

1. Placing the front harness (G) on your pet

1.1 Detach front harness from the assembled wheelchair.

1.2 Unclip the front harness' leg strap (red strap). Guide your pet's head through the black straps, these two are to go below the neck, in front of the forelegs; and over the back and shoulder area.



1.3 The front harness' red strap should be positioned at the bottom. It will go behind the forelegs and across the bottom chest to clip and lock on the other side.

1.4 Adjust the front harness so that it fits your pet snugly yet comfortably.

2. Placing the rear harness on your pet

You must start with Sports Harness

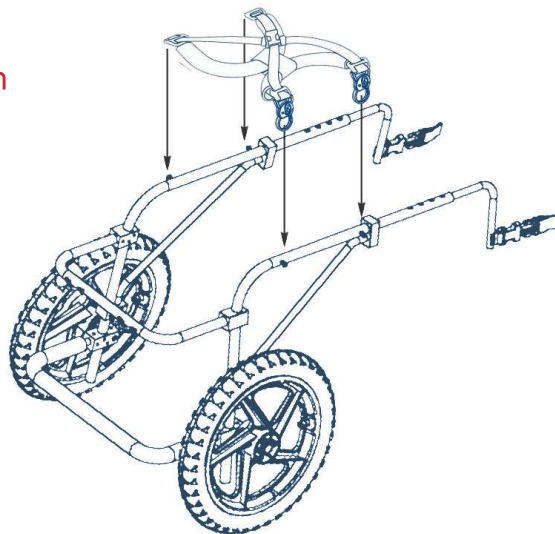

NOTE: We highly recommend starting with the sports harness (M). This harness is designed specifically for active dogs and gives a bit better range of motion. It is fully adjustable, lightweight, and comfortable. It is great for various activities and we've found that many dogs, especially the younger ones, prefer the sports harness over the comfort harness.

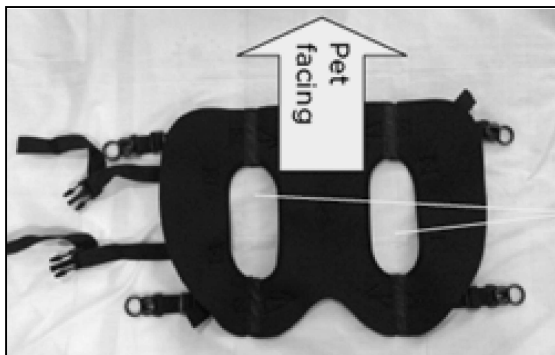

- 2.1 Unclip the comfort harness (F) from assembled wheelchair.
- 2.2 Lay the comfort harness down by your pet's hind legs. Guide your pet's paws over the corresponding leg holes rear harness and pull the harness up through your pet's legs.
- 2.3 Pull the straps from the side and place them over your pet's back until you can lock the side release buckles. Adjust the straps for comfort and firmness.



- 2.4 Bring the wheelchair behind your pet. Move it forward until your pet is positioned in the middle of the wheelchair.



2.5 Connect the comfort harness into the side arm bolts by snapping on the O-connectors to the side arm bolts.

2.6 Adjust lift or the rear harness to a comfortable weight-bearing position.

2.7 Snap on the front harness (G) to the front harness bar side release buckles.

3. If you choose to use the sports harness (M)

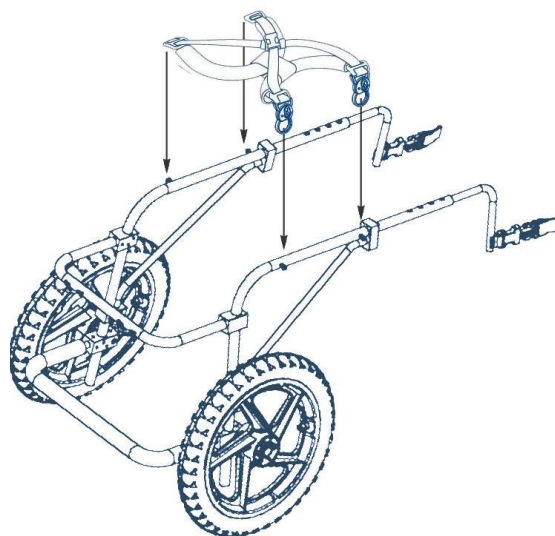

3.1 The sports harness must be installed to the main assembly before placing your pet in it.

3.2 Place the sports harness so that each O-connector clamp is level with and near a side arm bolt. Attach as directed in step number 5 of the Assembly instructions.

- 3.3 Bring the wheelchair behind your pet. Move it forward until your pet is positioned in the middle.
- 3.4 Lift your pet's rear and gently guide the hind legs down the sports harness.
- 3.5 Adjust the length of the sports harness' straps to a comfortable weight-bearing position for your pet using the adjuster buckles.
- 3.6 Fasten the back straps over you pet's back. Connect the lower left strap to the upper right and the lower right to the upper left strap so that both straps cross over your pet's lower back.



- 3.7 Snap on the front harness (G) to the front harness bar side release buckles.

4. Using the leg straps

- 4.1 For pets that are completely non-weight-bearing on their hind legs, use the leg straps to protect their hocks and keep them from dragging.
- 4.2 Attach leg straps to the rear harness bar.
- 4.3 Press the cord lock and pull on the cord to loosen the leg strap.
- 4.4 Insert each leg to a corresponding leg strap. Adjust closure to a comfortable tightness.
- 4.5 Make sure that legs can rest at a comfortable angle.

NOTES ON FIT

Checking Correct Height Setting

- For pets **without the use** of their hind legs: while standing still on a level surface, the height of the wheelchair should be set so that the shoulders and hips are even.

Please note that when your pet is walking or running, their backs will not stay even due to their movement.

- For pets **with the use** of one or both its hind legs, the wheelchair height needs to be set so that their paws are able to lightly graze the ground and provide them with enough traction to push off with the rear paws.

Often, pets experiencing weakness in their rear legs are affected on one side more than the other. While on their wheelchair, one paw might knuckle over and lead them to depend on the stronger leg more often or lean on that side of the wheelchair. This is something to watch out for so that it can be corrected and countered. A paw that gets knuckled over can be protected by a bootie. And while we cannot stop some pets from favoring their stronger leg, we can help them avoid leaning against the wheelchair and possibly injuring themselves. Do this by placing a piece of foam or a folded towel to act as padding between the leg and the side they are leaning against.

The two side arms of the Rear Support Wheelchair's frame should be parallel to your pet's back and generally, a couple of inches below the top of his or her back. The wheelchair's height may vary depending on your pet's build (e.g. shoulders being lower than the hip). When the harnesses are positioned properly on the side arms, according to your pet's length, the forelegs should in no way rub against them while your pet is walking.

The front harness should rest comfortably under your pet's forelegs. The rear harness should also be adjusted with comfort in mind. Do not raise the rear harness to an angle that is unnatural for your pet.

Make sure to have the front harness' front strap sit slightly above the center of the chest. Never allow it to press against the throat or rest below the center of the chest; such placement may be harmful to your pet. Adjust all straps so that they are comfortably snug; do not overtighten.



The Best Friend Mobility Rear Support Wheelchair is fully adjustable. With just a few adjustments, you can ensure proper fit and make it a safe vehicle for your pet. Avoiding misuse and common errors will allow your pet to quickly start enjoying the use of this mobility aid.

PROBLEM	SOLUTION
The wheelchair tips backward.	<ul style="list-style-type: none">• Make sure that the frame's side arm height is a couple of inches below your pet's back. Adjust the front posts.• Make sure the length is appropriate for your pet. Adjust the side arms and/or straps.• Check the front harness. Make sure that it is centered across your pet's chest. Adjust the straps and see if this keeps the wheelchair from tipping.
The wheelchair tips forward.	<ul style="list-style-type: none">• Make sure that the frame's side arm height is a couple of inches below your pet's back. Adjust the front posts.• Check the front harness. Make sure that it is centered across your pet's chest. Adjust the straps and see if this keeps the wheelchair from tipping.• Check weight balance. Make sure the wheel is positioned toward the middle or front of the connector blocks; adjust if needed. Make sure the side arms and all the straps are adjusted to their new positions accordingly, keeping in mind previous instructions.
Your pet loses breath while moving using wheelchair.	<ul style="list-style-type: none">• Check the front harness. If it is positioned too high, it will press against your pet's throat when walking. Adjust front harness height so that your pet can breathe freely especially while moving.

PROBLEM	SOLUTION
<p>Pet's hind legs not comfortably resting on the rear harness and harness does not extend beyond pet's rear.</p>	<ul style="list-style-type: none"> • The angle of the harness is too high. Adjust harness height so that your pet's legs are at a comfortable and natural height.
<p>Your pet takes shorter strides.</p>	<ul style="list-style-type: none"> • A too low front harness is the usual culprit. Adjust height so as not to hamper your pet's natural stride.
<p>The wheelchair's side arm bars are pointing downward.</p>	<ul style="list-style-type: none"> • Your straps may not be evenly distributed. <ol style="list-style-type: none"> 1. Loosen the lower girth strap (red strap) 2. Tighten the top girth strap enough to hold the side arm bars parallel to the ground. 3. Re-tighten the lower girth strap enough so that both straps are snug but comfortable.
<p>The wheelchair's side arm bars are pointing upward.</p>	<ul style="list-style-type: none"> • Same problem as above, uneven distribution of the straps this time favoring the opposite side. <ol style="list-style-type: none"> 1. Loosen the top girth strap. 2. Tighten the lower girth strap (red strap) to pull the side arm bars down parallel to the ground. 3. Re-tighten top girth strap.

CARE AND MAINTENANCE

Keep the Best Friend Mobility wheelchair clean. Your pet will surely appreciate it and ride with pride. Wipe down aluminum surfaces with warm, soapy water using a soft cloth such as a microfiber or cotton rag. Rinse and dry.

Check the bolts and screws frequently; retighten if loose. Adjust or tighten loose straps as well.

Remember to hose or wipe down tires to keep them from tracking dirt. Check tire pressure every so often and inflate when needed. To reduce bounce and increase traction, lessen tire pressure (to just under recommended PSI) to give the wheelchair a more comfortable ride.

Wash the sling, harness, and straps in cool, soapy water and hang them to dry. Opting for a perfume-free detergent will help your pet avoid skin irritation. You may want to try odor neutralizers (homemade or store-bought) to counter any smell that may remain in the harness.

CONTACT US

If you find that you have further questions regarding the use of the Best Friend Mobility wheelchair, please contact us at:

Best Friend Mobility
10838 Kings Rd. Myrtle Beach, SC 29572
Phone: (843) 492-5283
Email: support@dogwheelchairscenter.com



Best Friend Mobility
10838 Kings Rd. Myrtle Beach, SC 29572
(843) 492-5283
support@dogwheelchairscenter.com

