



solo Digital Clinical Scale Operation Manual

solo[®]
DIGITAL CLINICAL SCALES



0044-0391-0M Rev A
09/15

PO BOX 151 • WEBB CITY, MO 64870
PH (417) 673-4631 • FAX (417) 673-5001
www.detecto.com

Technical Support: Ph: 866-254-8261 • tech@cardet.com

TABLE OF CONTENTS

INTRODUCTION	1
SPECIFICATIONS	1
FEATURES	1
INSTALLATION	2
Unpacking	2
Assembly	3
UNIT SELECTION	6
BATTERY OPERATION	6
Installation/Replacement	6
Low Battery	7
Automatic Shutoff	7
OPTIONAL AC POWER ADAPTER	8
OPERATION	9
Keypad Functions	9
Annunciators	11
Weighing Mode.....	13
Height and/or BMI Measure Mode (using solo Height Rod or No Height Rod)	14
Optional BMI Mode	14
solo Height Rod Operation	15
SETUP	16
CALIBRATION	18
SERIAL DATA FORMAT	20
DISPLAY MESSAGES	21
TROUBLESHOOTING	21
CARE AND CLEANING	22

Serial Number _____

Date of Purchase _____

Purchased From _____

RETAIN THIS INFORMATION FOR FUTURE USE

PRECAUTIONS

Before using this scale, read this manual and pay special attention to all "NOTIFICATION" symbols:



IMPORTANT



ELECTRICAL
WARNING

Proper Disposal

When this device reaches the end of its useful life, it must be properly disposed of. It must not be disposed of as unsorted municipal waste. Within the European Union, this device should be returned to the distributor from where it was purchased for proper disposal. This is in accordance with EU Directive 2002/96/EC. Within North America, the device should be disposed of in accordance with the local laws regarding the disposal of waste electrical and electronic equipment.

It is everyone's responsibility to help maintain the environment and to reduce the effects of hazardous substances contained in electrical and electronic equipment on human health. Please do your part by making certain that the device is properly disposed of. The symbol shown to the right indicates that this device must not be disposed of in unsorted municipal waste programs.



FCC Compliance Statement

This equipment generates, uses and can radiate radio frequency and if not installed and used in accordance with the instruction manual, may cause interference to radio communications. It has been designed within the limits for a Class A computing device pursuant to Subpart J of Part 15 of FCC rules to provide reasonable protection against such interference when operated in a commercial environment. Operation of this equipment in a residential area may cause interference in which case the user will be responsible to take whatever measures necessary to correct the interference.

You may find the booklet "How to Identify and Resolve Radio TV Interference Problems" prepared by the Federal Communications Commission helpful. It is available from the U.S. Government Printing Office, Washington, D.C. 20402. Request stock No. 001-000-00315-4.

Copyright

All rights reserved. Reproduction or use, without expressed written permission, of editorial or pictorial content, in any manner, is prohibited. No patent liability is assumed with respect to the use of the information contained herein.

Disclaimer

While every precaution has been taken in the preparation of this manual, the Seller assumes no responsibility for errors or omissions. Neither is any liability assumed for damages resulting from use of the information contained herein. All instructions and diagrams have been checked for accuracy and ease of application; however, success and safety in working with tools depend to a great extent upon the individual's accuracy, skill and caution. For this reason the Seller is not able to guarantee the result of any procedure contained herein. Nor can they assume responsibility for any damage to property or injury to persons occasioned from the procedures. Persons engaging the procedures do so entirely at their own risk.

INTRODUCTION

Thank you for purchasing our Detecto solo Digital Clinical Scale. Your scale has been designed for simple and straightforward use and to assure accuracy and dependability for years to come.

Please read this manual thoroughly before using your scale and keep it handy for future reference. It contains important instructions for installation and proper operation of your scale.

SPECIFICATIONS

Model Number:	solo
Capacity:	550 lb x 0.2 lb (250 kg x 0.1 kg)
Weight Units:	Pounds or Kilograms (selectable)
Power Requirements:	Six (6) "AA" size Alkaline batteries (<i>included</i>) OR an optional medical device 9V AC/DC wall plug-in adapter (Cardinal part number PD-ACKIT, includes UK plug, EU plug and USA plug).
Display:	Five digit, seven segment, 1.0 inch (25 mm) high LCD
Operation Temperature:	50 to 104 °F (+10 to +40 °C)
Function Keys:	ON/OFF, BMI HEIGHT, ENTER, LOCK/RELEASE, PRINT, ZERO, ▲UP ARROW and ▼DOWN ARROW
Dimensions:	14.3 in W x 19.5 in D x 52.0 in H (36.3 cm W x 49.5 cm D x 132.1 cm H)
Weight:	17.7 lb (7.7 kg)
Interface:	RS-232 Serial Port, 9-Pin (DE-9M), 9600 Baud, 8 bits, No Parity, and 1 Stop Bit
Height Rod Units:	Inch or cm
Height Rod Range:	30 to 84.5 inches (76 to 214.5 cm)

FEATURES

- Minimum weighing: 11lb (5kg)
- Selectable Auto Shut-Off Feature (up to 9 minutes)
- Body Mass Index (BMI) Calculator
- Weight only
- Manual Input Height 2' 0.0" to 7' 10.5" by 0.5" (60.0 cm to 240.0 cm by 1cm)
- lb /kg
- Print function (ASCII printing protocol)
- Buzzer (A short beep when a key is pressed, and a long beep for when weight is stable and locked.)

INSTALLATION

Unpacking

Remove Display with Upper Outside and Inside Column (already assembled), Lower Inside Column, Lower Outside Column, Scale Platform and Hardware Pack from shipping carton. After removing from carton, check for any damage that may have taken place during shipment. *Keep and use the original carton and packing material for return shipment if it should become necessary.* The purchaser is responsible for filing all claims for any damages or loss incurred during transit. Remove all plastic wrapping, foam fillers and cardboard material from scale platform, display and other components. You should have the following components:

- ① Display with Upper Outside and Inside Column (pre-assembled)
- ② Lower Inside Column
- ③ Lower Outside Column
- ④ Scale Platform (with Column Housing Cover)
- ⑤ Hardware Pack, containing:
 - (4) M5 x 15 Machine Screws
 - (4) Lock Washers
 - (2) M3 x 12 Screws

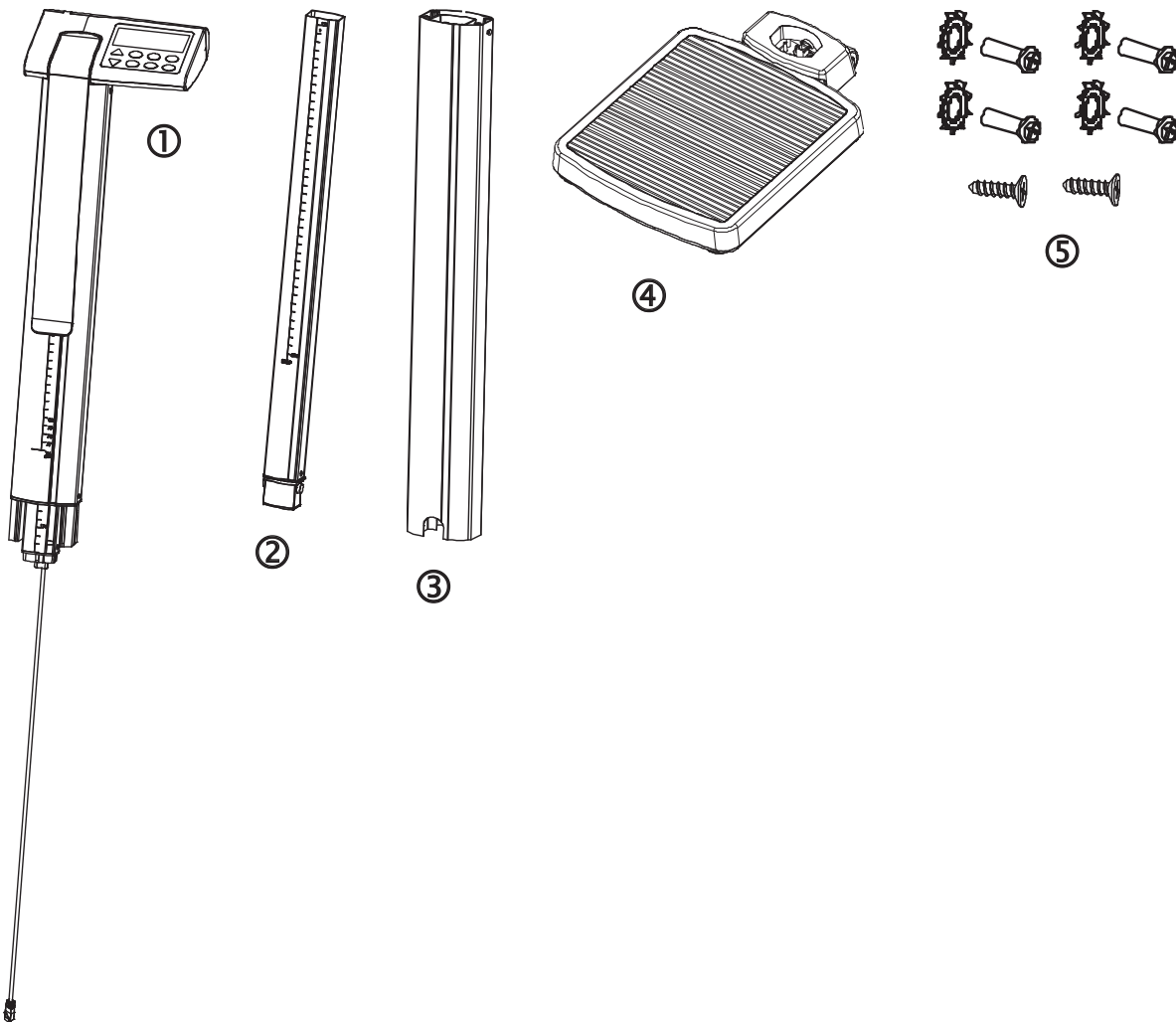

INSTALLATION, CONT.

Assembly

Step 1

1. Align Part 2 (lower inside column) with Part 1 (pre-assembled display upper outside and inside column).
2. Press the parts together until the locking tab snaps in place.
3. Ensure that the locking tab is locked securely.

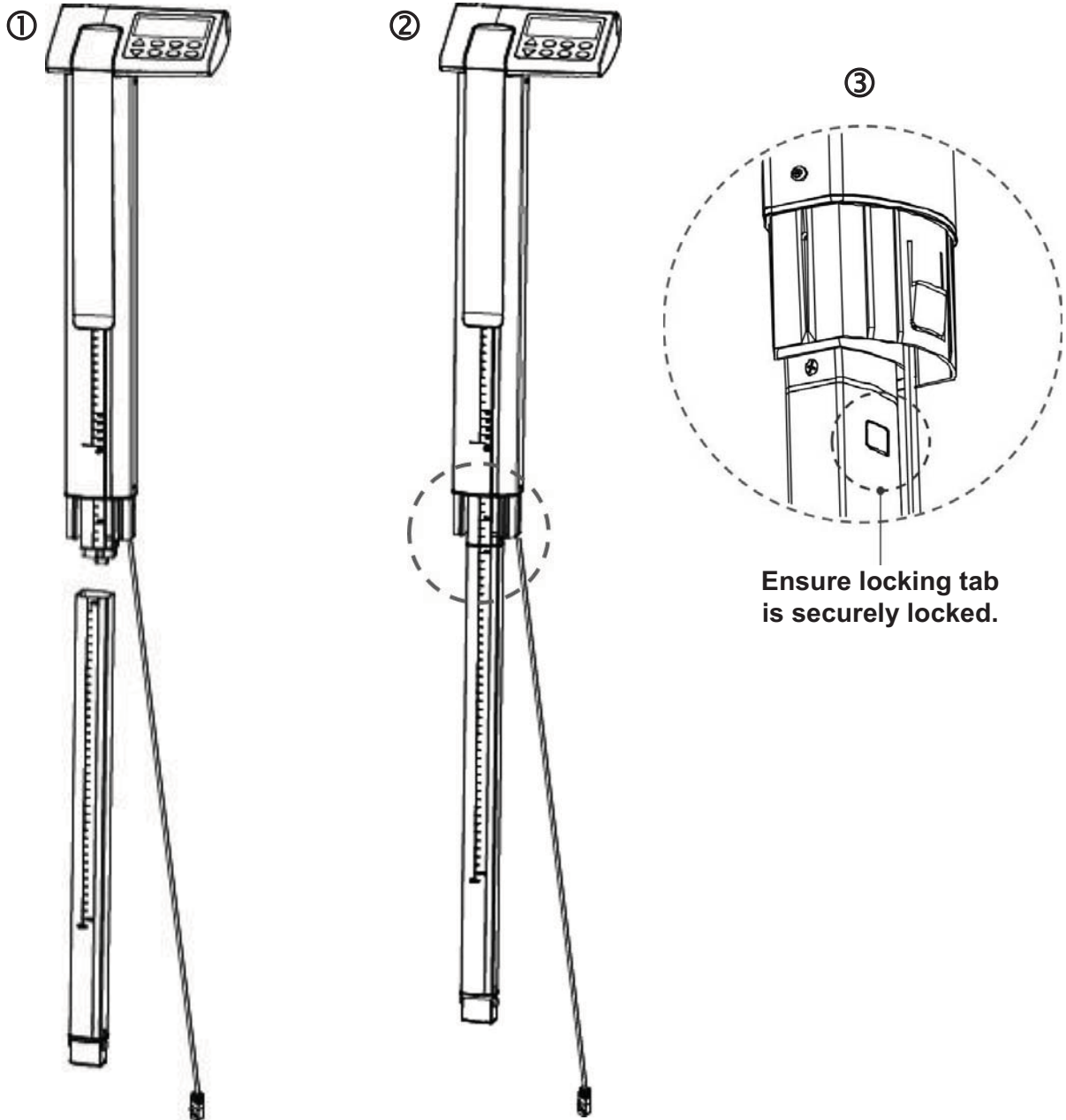

INSTALLATION, CONT.

Assembly, Cont.

Step 2

1. Align Part 3 (lower outside column) with assembled Part 1 and 2 (display upper outside and inside column, and lower inside column).
2. Press the locking tab (on Part 2, lower inside column) inward and then insert into Part 3 (lower outside column).
3. Slide the cable connector through Part 3 (lower outside column).
4. Press Part 3 and Part (1 and 2) together until the locking tab snaps in place.
5. Ensure that the locking tab is locked securely.
6. Install the (2) M3 x 12 machine screws (one in each side of Part 3) to secure Part 1 and 2 together with Part 3.

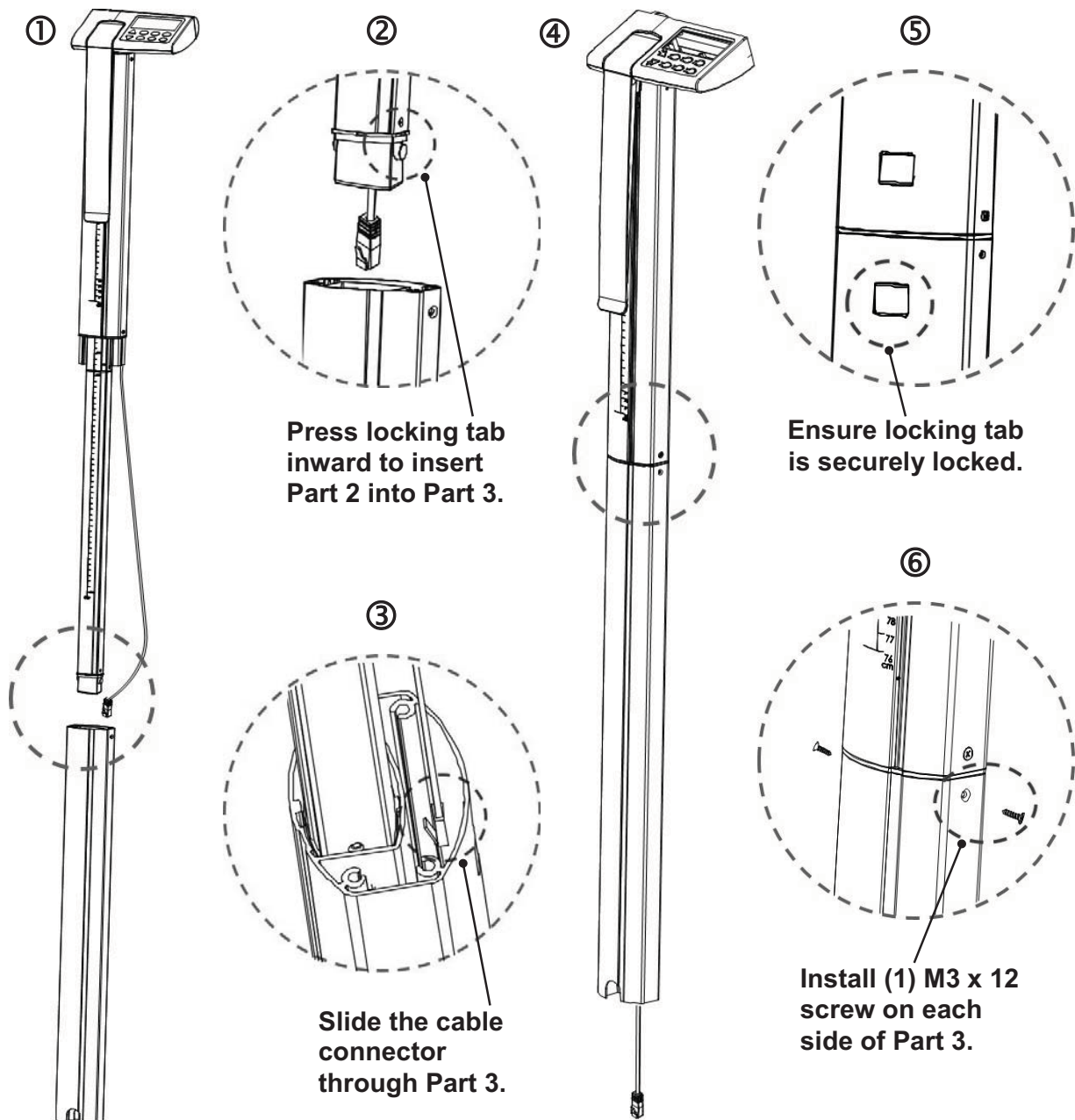

INSTALLATION, CONT.

Assembly, Cont.

Step 3

1. Plug the cable connector into the RJ jack located on the Part 4 (scale platform).
2. Align the display and assembled column with Part 4 (scale platform) and insert the column into opening of the scale platform.
3. While holding the column in place, carefully lay the scale down with the column horizontal to floor.
4. Attach the column to the scale platform by inserting the (4) M5 x 15 machine screws and lock washers through the holes in the scale platform into the threaded holes of the column. Tighten the screws to secure the column to the scale platform.

The scale should be placed on a flat, level hard-surfaced floor or low-cut, unpadded carpet, away from any rapidly moving air source (heating and cooling vents).

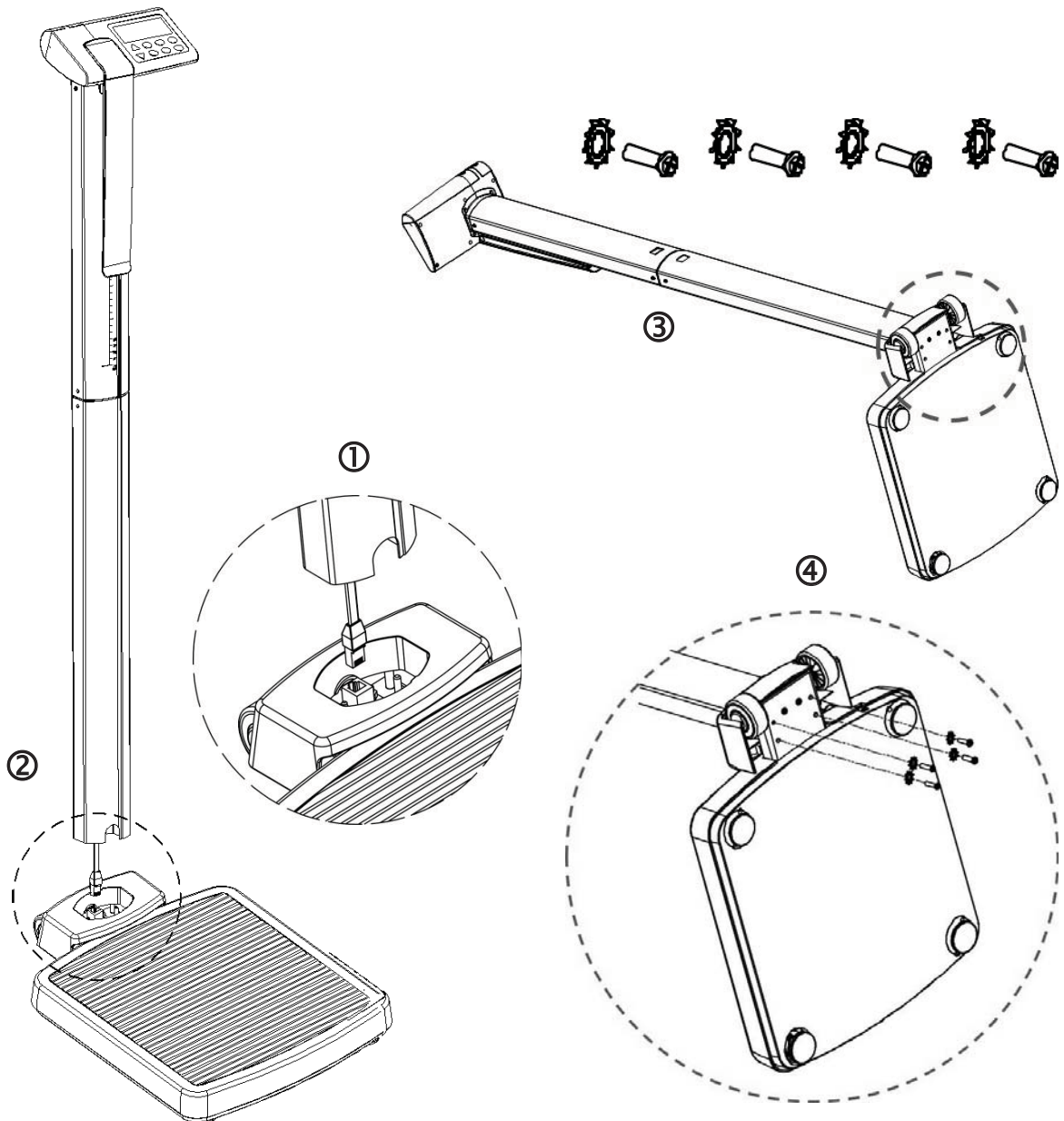

UNIT SELECTION

When the scale is powered on for the first time, all digits on the display will turn on and then change to show the software version for a few seconds and finally prompt for which weighing unit to use, **lb** or **kg**.

1. The display will show *Unit*, and flash the lb annunciator, the current unit setting. If the setting displayed is acceptable, press the “←” key to save it. Otherwise, use the ↑ or ↓ keys to select a different unit **lb / kg** and then press the “←” key to save it.
2. The display will change to show a small *o* moving across the display and then show *0.0*.
3. The scale is now ready for operation.
4. Once the unit is set it will be kept. To change unit setting the scale must be Re-Initialized by turning the scale off, then press and hold the “→0←” and the “⊙” keys at the same time. Scale will power on. Follow the steps above.

BATTERY OPERATION

To operate the solo Digital Clinical Scale from batteries, you must first install the included six (6) "AA" size alkaline batteries. Batteries are contained in a battery holder inside the display. Access is via a removable cover on the back of the display.

Installation/Replacement

To install or remove the batteries, the following steps should be followed:

1. Standing behind the scale, locate the battery cover on the back of the display.

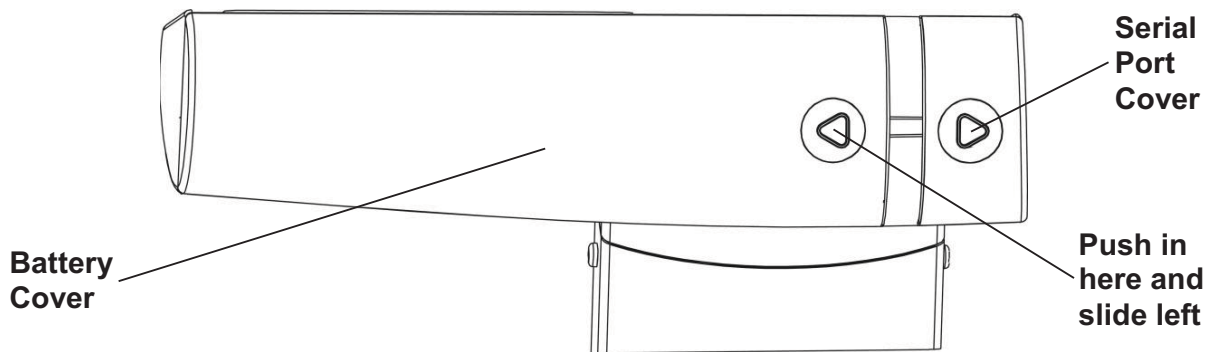

2. To install or replace the batteries, first remove the battery cover by pushing in on the arrow and sliding the cover approximately 3/4" (20mm) to the left and then lifting it away from the display.
3. If installing new batteries, proceed to step 4. If replacing the batteries, remove all six (6) batteries from the battery holder, then proceed to step 4.

BATTERY OPERATION, CONT.

4. Install the six (6) new “AA” size batteries in the battery holder, noting the polarity markings located in the battery holder.

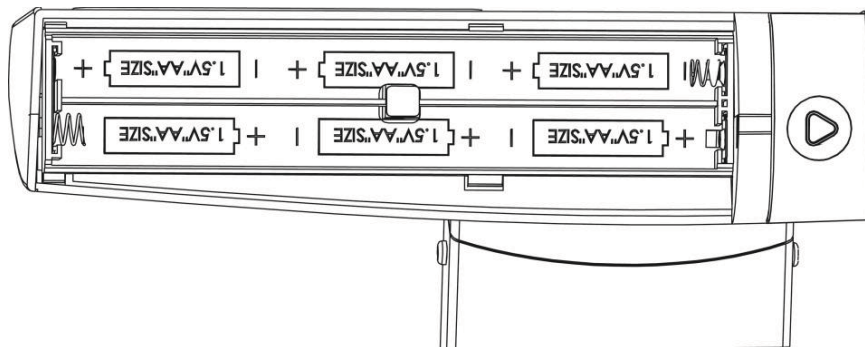

5. Replace the battery cover on the back of the display approximately 3/4" (20mm) from the right side of the display and then slide it to the right until locks in place (it will click when locked in place).
6. The display should turn on, show all digits, the software version for a few seconds, followed by a small \square moving across the display and then show 0.0 on the display.
7. The scale is now ready for operation.

NOTE: If the display did not turn on, remove the battery cover and check for one or more improperly positioned batteries.

Low Battery

When the batteries are near the point they need to be replaced, *LoBAt* will be shown on the display. If the battery voltage drops too low for accurate weighing, the scale will shut off and you will be unable to turn it back on. When the *LoBAt* message is displayed, the operator should replace the batteries or remove the batteries and plug-in the 9V AC/DC adapter.

Automatic Shutoff

The Automatic Shutoff feature will turn the scale off after a period of inactivity (no motion or weight on scale) to prolong battery life. The period of inactivity for the automatic shutoff is selected during the setup process of the scale and can be set for up to nine (9) minutes. To turn the scale back on, you simply press the “” key.

OPTIONAL AC POWER ADAPTER

To power the scale using the optional Medical device 9V AC/DC wall plug-in adapter, connect the plug from the adapter into the power jack on the back of the scale base and then plug the power adapter into the proper electrical outlet. On models requiring 220 VAC, it is the customer's responsibility to obtain the correct power adapter plug. The scale is now ready for operation.

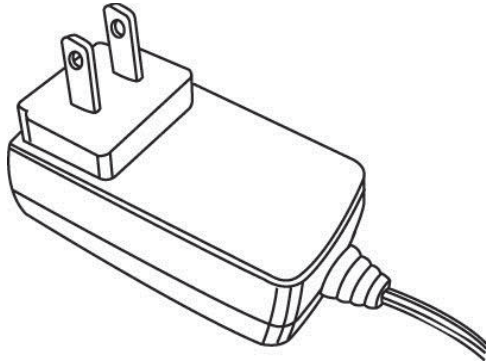

**Optional PD-AC
(Medical device 9V AC/DC
Adapter, includes USA Plug)**

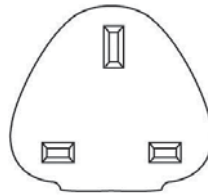

**Optional
PD-UKPLUG
(UK Plug)**

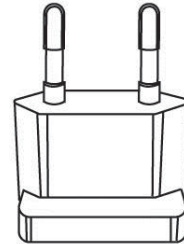

**Optional
PD-EUPLUG
(EU Plug)**

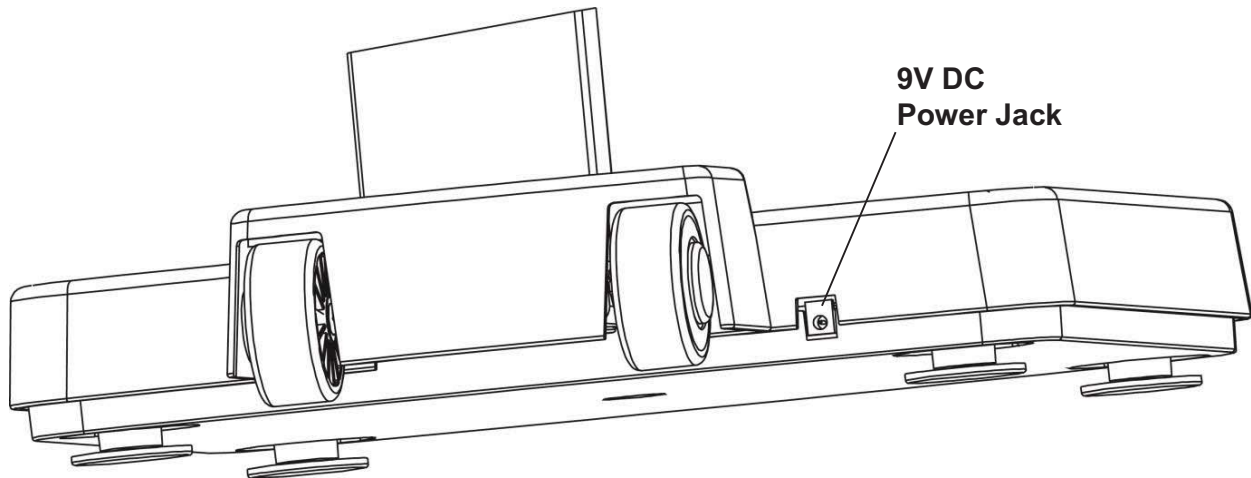

OPERATION

Keypad Functions



DO NOT operate the keypad with pointed objects (pencils, pens, etc.). Damage to keypad resulting from this practice is **NOT** covered under warranty.

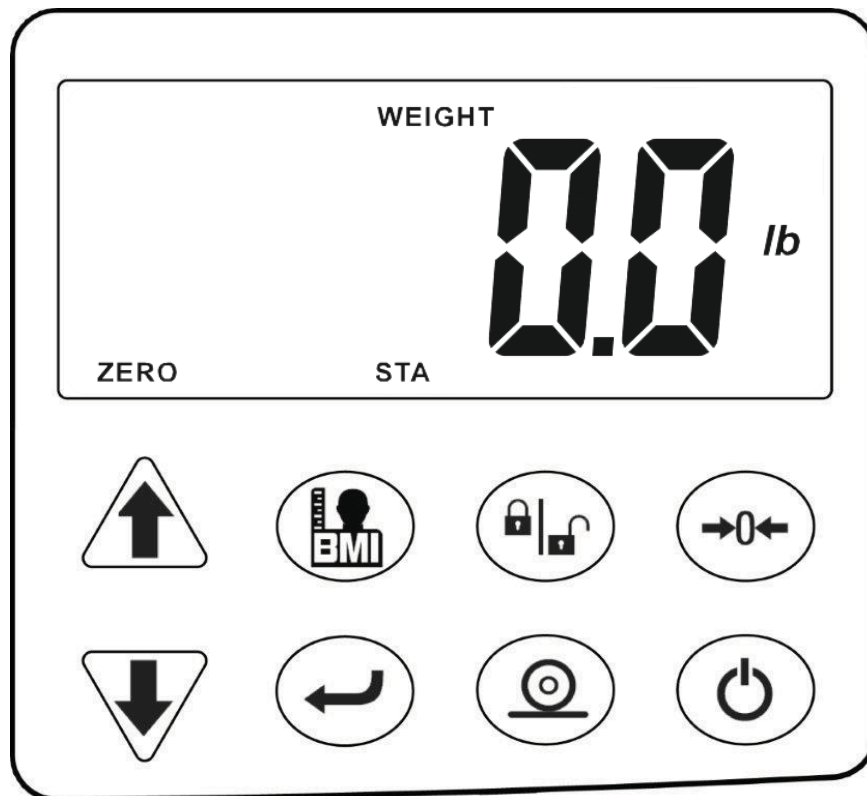

ON/OFF

With the scale off, pressing this key will apply power to the scale and turn on the display. If the scale is on, pressing this key will turn the scale off.



PRINT

This key is used to send the weight and associated data to the serial port.



ENTER

This key serves two purposes. First, when reviewing setup parameters, pressing the “↩” key will accept the current displayed setting of the parameter. Second, the “↩” key is used to signal completion of the entry of data (in both setup and operation) and causes the scale to process the data entered.

OPERATION, CONT.

Keypad Functions, Cont.



ZERO

This key is used to reset the display to zero. Note that if the “zero” key is pressed with weight on the scale platform, the display will tare the weight and change to 0.0. When the weight is removed, the display will show a negative weight value and then change to 0.0.



LOCK/RELEASE



This key is used to lock and unlock the display. Pressing this key will cause the display to lock onto the weight and remain displayed after the patient steps off the scale. Pressing the key again will unlock the display and return it to zero.

NOTE: The scale will not respond to pressing the “” key unless the weight is stable and the STA annunciator is turned on.



BMI

The **BMI** key is used to input the patient’s height and then to perform the Body Mass Index (BMI) calculation. Note that the scale will not respond to pressing the key unless the weight is stable.

When using the solo height rod (or no height rod), pressing the key once allows the operator to enter the height of the patient using the  or  keys to increment or decrement to the correct height. After entering the patient’s height, pressing it again will display the Body Mass Index (BMI) calculation. Pressing it a third time, will return the display to the patient’s weight.

NOTE: While the patient is still standing on the scale, pressing the “” key will toggle between BMI and weight display. Also, note that once the patient steps off the scale, the display automatically returns to the weight only mode.



UP ARROW

This key is used when performing the Body Mass Index (BMI) calculation to increase the height value.



DOWN ARROW

This key is used when performing the Body Mass Index (BMI) calculation to decrease the height value.



During setup and calibration, the arrow keys are used to select setup and calibration values.

OPERATION, CONT.

Annunciators

The annunciators are turned on to indicate that the scale display is in the mode corresponding to the annunciator label or that the status indicated by the label is active.

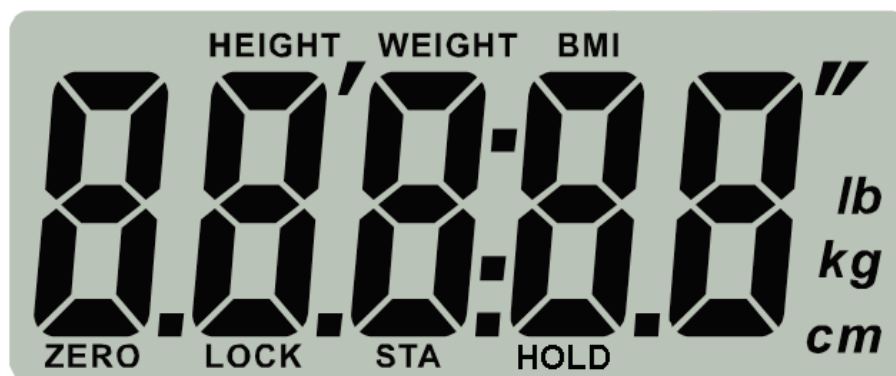

ZERO

This annunciator is turned on to indicate that the weight displayed is within +/- 1/4 division of the center of zero.

LOCK

This annunciator is turned on to show that the scale is locked onto the displayed weight.

STA

This annunciator is turned on when the weight on the scale is stable.

HOLD

This annunciator is turned on to show that the weight display is locked with the last stable weight reading.

lb

This annunciator is turned on to indicate that the displayed weight is in pounds.

kg

This annunciator is turned on to indicate that the displayed weight is in kilograms.

cm

This annunciator is turned on when the displayed height measurement is in centimeters.

' "

These annunciators are turned on when the displayed height measurement is in feet and inches.

HEIGHT

This annunciator is turned on when the scale is in the height measurement mode.

WEIGHT

This annunciator is turned on when the scale is in the weight only mode.

OPERATION, CONT.

Annunciators, Cont.

BMI (Body Mass Index)



This annunciator is turned on when displaying the calculated Body Mass Index.

OPERATION, CONT.



ALWAYS assist the patient when stepping on and off the scale platform to ensure they do not fall. **NEVER** leave a patient unattended while they are on the scale platform. Failure to maintain control of the patient at all times can result in serious injury to you and/or the patient.

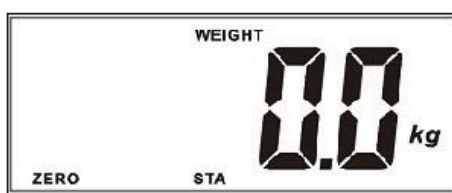
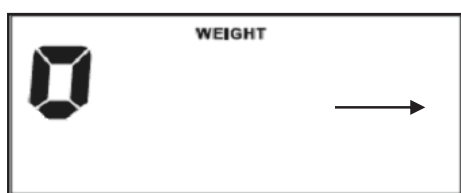

Weighing Mode

1. Press the “” key. The scale will turn on and then display the software version for a few seconds.
2. Next, a small  is shown and moves across the display until a stable zero is established.
3. After establishing zero, the scale will show 0.0 on display. Note that if the scale cannot establish zero, the display will show *Err0* for a few seconds and turn the scale off.



4. Assist patient onto scale.
5. When the weight is stable, the weight reading will flash one time, a long beep will sound, the reading will automatically lock and the LOCK annunciator will turn on. Note that the lock will be released once the patient steps off the scale.

NOTE: If the weight increases or decreases more than 2kg while the weight reading is locked, the locked weight will automatically be released, and the new weight will be locked when it's stable.

6. Press the “” key to hold the current weight reading. It will remain on the display after the patient steps off the scale. Press the “” key again to release the current weight reading.

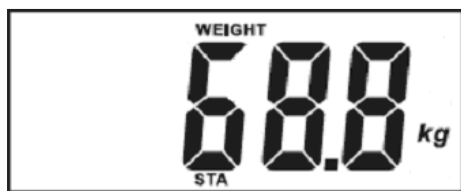

(Released)

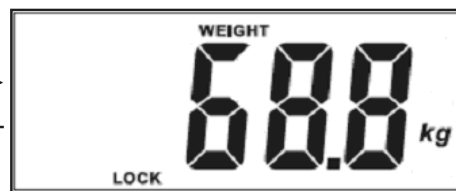







(Hold)

7. Assist patient off scale.
8. To turn scale off, press the “” key.









If the Automatic Shutdown feature has been enable, the scale will turn off after a pre-defined time of inactivity (no motion or weight on scale).

OPERATION, CONT.

Height and/or BMI Measure Mode (using solo Height Rod or no Height Rod)

1. Assist patient onto scale.
2. The display will show the patient's weight.
3. Read and record weight displayed.
4. Press the " key to enter the Height mode.
5. Scale display show 5'00.0" if units is pounds or 150.0 cm if units is kilograms.
6. Press the  or  keys to increment or decrement to correct height.
7. Press the " key. The display will change to show the BMI (Body Mass Index).
8. Read and record patient's BMI.
9. Press the " key once more and the scale returns to patient's weight.
NOTE: While the patient is still standing on the scale, pressing the " key will toggle between BMI and weight display.
10. Assist patient off scale
11. Once patient steps off scale, display automatically returns to weight only mode.
12. To turn scale off, press the " key.
If the Automatic Shutdown feature has been enable, the scale will turn off after a pre-defined time of inactivity (no motion or weight on scale).

Optional BMI Mode

1. Press the " key.
2. The scale will show 0.0 on display.
3. Press the " key. The display will go blank and the BMI annunciator will turn on.
4. Assist patient onto scale. The patient's weight will be displayed.
5. When weight is stable and locked, the scale automatically changes to the Height mode.
6. Scale display show 5'00.0" if units is pounds or 150.0 cm if units is kilograms.
7. Press the  or  keys to increment or decrement to correct height.
8. Press the " key. The display will change to show the BMI (Body Mass Index).
9. Read and record patient's BMI.
10. Press the " key once more and the scale returns to patient's weight.
NOTE: While the patient is still standing on the scale, pressing the " key will toggle between BMI and weight display.
11. Assist patient off scale
12. Once patient steps off scale, display automatically returns to weight only mode.
13. To turn scale off, press the " key.
If the Automatic Shutdown feature has been enable, the scale will turn off after a pre-defined time of inactivity (no motion or weight on scale).

OPERATION, CONT.

solo Height Rod Operation

1. Lift headpiece on height rod to horizontal position.
2. Referring to the illustration to the right, lift headpiece and raise it well above estimated height of patient's head.
3. Assist patient onto scale.
4. Carefully lower inner height rod (press down against height rod display cover while keeping headpiece horizontal) until headpiece rests on top of patient's head.
5. If patient is shorter than 47" (120 cm), push height rod display cover down flush with display and then push headpiece down until it rests on top of patient's head.
6. Read height of patient as follows:

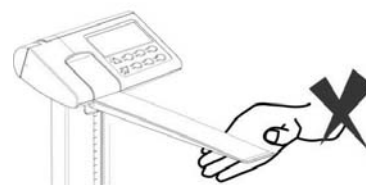
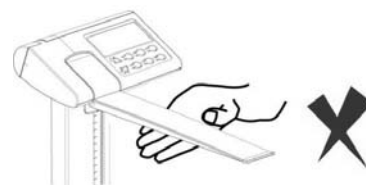
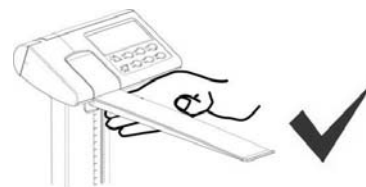

If patient is shorter than 47" (120 cm), the correct height is read at the red edge on the bottom of the headpiece.

If patient is 47" (120 cm) or taller, the correct height is read at the red edge on the outer column.

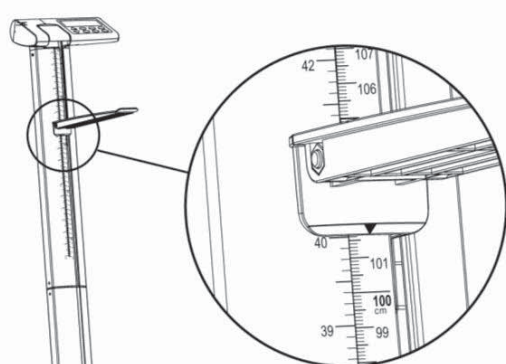

Read height at red edge on bottom of headpiece if shorter than 47" (120 cm).

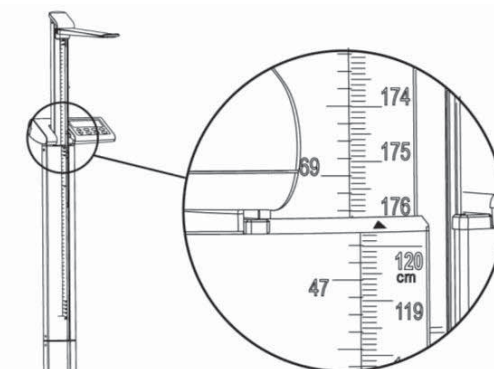

If taller than 47" (120 cm), read height at red edge on outer column.

7. Referring to the illustration above, lift headpiece (while keeping it horizontal) and raise it above patient's head.
8. Assist patient off scale.
9. Lower headpiece back to vertical position and return height rod to the "stored" position (headpiece should be vertical against outer column and height rod display cover should be flush with the display).

SETUP

Your solo Digital Clinical Scale has been pre-configured at the factory and should not require changes for use in most applications. However, if the factory settings do not meet the requirements of your operation, the following describes the setup process for your scale.

To Enter Setup

1. With the scale off, press hold the “→0←” key and then press the “⏻” key to turn on the scale.
2. The display will turn on all digits, show the software version for a few seconds and then change to show *mm:00*.
3. Release all keys.
4. The scale is now ready for setup.



IMPORTANT: When a prompt and value displayed are acceptable, press the “←” key to save the setting and proceed to the next prompt. To change a setting, press the ↑ or ↓ keys to adjust the setting (or select a new value) and then press the “←” key to save the new setting and advance to the next prompt.

mm: (Minutes)

The display will show *mm:00*, the current Minutes setting. If value displayed is acceptable, press the “←” key to save it and proceed to the next prompt. Otherwise, press the ↑ or ↓ keys to select a new value from 00 to 59 and then press the “←” key to save it and proceed to the next prompt.

NOTE: The default minute setting is 00.

hh: (Hours)

The display will show *hh:00*, the current Hours setting. If value displayed is acceptable, press the “←” key to save it and proceed to the next prompt. Otherwise, press the ↑ or ↓ keys to select a new value from 00 to 23 and then press the “←” key to save it and proceed to the next prompt.

IMPORTANT! Time is entered in a 24-hour format. When entering times after noon (12:00 PM), you must add 12 to time. For example, 3:00 PM would be entered as 15.

NOTE: The default hour setting is 00 (mid-night).

yy: (Years)

The display will show *yy:00*, the current Years setting. If value displayed is acceptable, press the “←” key to save it and proceed to the next prompt. Otherwise, press the ↑ or ↓ keys to select a new value from 00 to 99 and then press the “←” key to save it and proceed to the next prompt. Note that 00 represents year 2000, 01 represents 2001 and so on.

NOTE: The default year setting is 00 (2000).

SETUP, CONT.

mm: (Months)

The display will show *mm:01*, the current Months setting. . If value displayed is acceptable, press the “←” key to save it and proceed to the next prompt. Otherwise, press the ↑ or ↓ keys to select a new value from 01 to 12 and then press the “←” key to save it and proceed to the next prompt. Note that 01 represents January, 02 represents February so on.

NOTE: The default month setting is 01 (January).

dd: (Day)

The display will show *dd:01*, the current Day setting. . If value displayed is acceptable, press the “←” key to save it and proceed to the next prompt. Otherwise, press the ↑ or ↓ keys to select a new value from 01 to 31 and then press the “←” key to save it and proceed to the next prompt.

NOTE: The default day setting is 01 (first day of month).

ASH (Automatic Shutoff)

The display will show *ASH_ _*, the current Automatic Shutoff setting. . If value displayed is acceptable, press the “←” key to save it and proceed to the next prompt. Otherwise, press the ↑ or ↓ keys to select a new value and then press the “←” key to save it and proceed to the next prompt. Allowable values are 00 to 09 minutes in 1 minute increments. Note that selecting 00 disables the automatic shutoff feature.

NOTE: The default Automatic Shutoff setting is *ASH03* (3 minutes).

bu (Buzzer Setting)

In operation mode, if an incorrect key is pressed, the scale will sound two beeps as a warning and the operation will not be processed.

The display will show *bu*, the current Buzzer setting. If value displayed is acceptable, press the “←” key to save it and proceed to the next prompt. Otherwise, press the ↑ or ↓ keys to select enable or disable the Buzzer and then press the “←” key to save it and proceed to the next prompt. Allowable values are 0 (disable) or 1 (enable).

NOTE: The default Buzzer setting is 1 (enable).

Setup Complete

Once the “←” key has been pressed at the *bu* prompt, all Setup settings (current or new values) will be saved and the scale will turn off.

CALIBRATION

Your solo Digital Clinical Scale was calibrated at the factory and should not require adjustment. In the event that the scale should need re-calibration, the following describes the calibration procedure. To maintain the instrument's high degree of accuracy, a qualified technician should perform this function.

Before beginning calibration, the following equipment is required:

150 kg or 300 lb of calibrated test weight

To Enter Calibration

1. With the scale off, press and hold the “←” and “→0←” keys and then press the “⏻” key to turn on the scale.
2. The display will turn on and show *SEtGC*.
3. Release all keys.
4. The scale is now ready for calibration.



IMPORTANT! When a prompt and value displayed are acceptable, press the “←” key to save the setting and proceed to the next prompt. To change a setting, press the ↑ or ↓ keys to adjust the setting (or select a new value) and then press the “←” key to save the new setting and advance to the next prompt.

SEtGC (Set Calibrated Gravity Constant)

This setting (e.g. *9787*) is the acceleration of gravity constant value for the location where the scale was calibrated.

With the display showing *SEtGC*, press the “←” key to show current setting. If the value displayed is acceptable, press the “←” key and proceed to the next prompt. Otherwise, press the ↑ or ↓ keys to adjust the setting then press the “←” key to save it and proceed to the next prompt.

Allowable values are 9.700 through 9.900.

OPrGC (SET OPERATED GRAVITY CONSTANT)

This setting (e.g. *9813*) is the acceleration of gravity constant value for the location where the scale will be operated.

With the display showing *OPrGC*, press the “←” key to show current setting. If the value displayed is acceptable, press the “←” key and proceed to the next prompt. Otherwise, press the ↑ or ↓ keys to adjust the setting then press the “←” key to save it and proceed to the next prompt.

Allowable values are 9.700 through 9.900.

CALIBRATION, CONT.

CAL n (Calibrate Scale)

- Step 1.** The display will change to show *CAL n*.
- Step 2.** To skip calibration and save the previous settings, press the “←” key to exit calibration. The scale will turn off automatically. Proceed to Step 14.
- Step 3.** Otherwise, press the ↑ or ↓ keys to select *Y* (Y = start calibration). Note that you can still select *n* (n = exit calibration), skip calibration and turn the scale off.
- Step 4.** Press the “←” key.
- Step 5.** The display will change to show the internal count.
- Step 6.** Make certain the scale platform is empty and free of debris.
- Step 7.** Press the “←” key to save the zero reference point.
- Step 8.** The display will change to show the first calibration point *50 kg* or *100 lb*
- Step 9.** Place the first calibrated test weight on the scale platform.
- Step 10.** When reading is stable, the first weight reading will be saved and the display will change to show the second calibration point *150 kg* or *300 lb*.
- Step 11.** Place the next calibrated test weight on the scale platform.
- Step 12.** When reading is stable, the second weight reading will be saved.
- Step 13.** The display will change to show *PASS* and then automatically shut the scale off.
- Step 14.** The scale is now ready for operation.

SERIAL DATA FORMAT

The serial port on the solo Digital Clinical Scale is a bi-directional port and can receive and transmit data. It can be used to communicate to a computer by pressing the “” key or transmitting a command to the scale.



NOTE: The serial output parameters are fixed at 9600 baud, with the data format at 8 bits, No parity, and 1 stop bit.

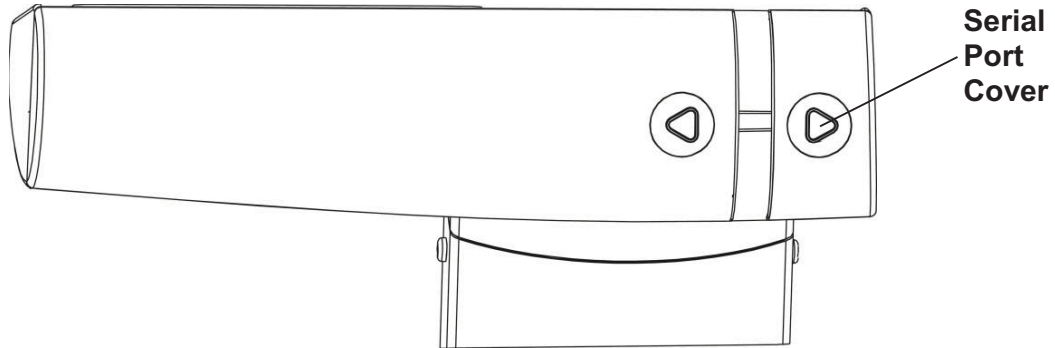

To connect to a computer, you will need a 9-Pin serial interface cable (Detecto part number 6600-1891) which is connected to the serial port located under the small cover on the back of the display.

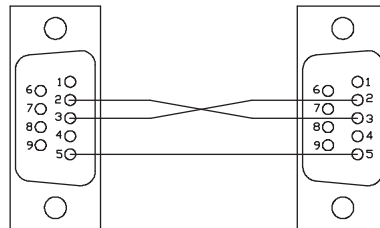

Output Format

The format below represents the output directly to a computer for processing of data and includes commas between each field and a carriage return to terminate the record.

Time, Date, BMI, Height, Weight <CR>

12:00,08/07/15,21.5,5'03.0",132.3lb

Remote Print Command

The host device (computer) sends:

<LF> P <CR>

This command is equivalent to pressing the “” key. The scale will respond by sending the above Output Format to the computer.

DISPLAY MESSAGES

The solo Digital Clinical Scale is equipped with software that tests various portions of the scale's circuitry and verifies proper operation. Should a problem be detected, a message will be displayed alerting the operator to that condition. The following lists the messages displayed and their meaning:

DISPLAY	MEANING
<i>Err0</i>	This will be displayed for a few seconds when the scale cannot establish zero and then turn the scale off. Refer to the TROUBLESHOOTING section.
<i>LoBat</i>	Displayed when the batteries are near the point they need to be replaced.
<i>OCAP</i>	Weight on scale exceeds 570 lb (260 kg).

TROUBLESHOOTING

Your scale has been designed to provide you with years of trouble-free operation. In spite of this, troubles sometimes happen. Before calling for service assistance you should make some initial checks to verify that a problem does exist. The following describes several types of symptoms along with suggested remedies.

PROBLEM	POSSIBLE SOLUTIONS
Display does not turn on	<p>Battery Operation:</p> <ul style="list-style-type: none"> • Check if batteries are installed and correctly. • Are batteries discharged? Remove old batteries and replace with new ones. <p>AC Operation:</p> <ul style="list-style-type: none"> • Is 9V AC/DC power adapter fully inserted into wall receptacle? • Check wall receptacle for proper AC power. Try another electrical appliance in same receptacle, does it work? • Check circuit breaker. • Has there been power failure?
Incorrect weight displayed	Ensure that the scale platform isn't touching an adjacent object. Have proper operation procedures been followed?
Display shows <i>Err0</i> and shuts off	If platform is not empty (patient is on scale) when powering up, display will show <i>Err0</i> and turn off. Remove any weight from platform (have patient step off scale) and power up the scale again. If scale continues to show <i>Err0</i> and turn off, consult your scale service representative.
Display shows a moving small \square	If the display shows a moving small \square when powering up, insure the scale is stable and wait for a moment until the display shows <i>0.0</i> . If scale continues to show a moving small \square , please consult your scale service representative.

CARE AND CLEANING

- **DO NOT** submerge scale in water, pour or spray water directly on the display.
- **DO NOT** use acetone, thinner or other volatile solvents for cleaning.
- **DO NOT** expose scale to temperature extremes.
- **DO NOT** place scale in front of heating/cooling vents.
- **DO** clean the scale and display with a damp soft cloth and mild non-abrasive detergent.
- **DO** remove power before cleaning with a damp cloth.
- **DO** provide clean AC power and adequate protection against lightning damage.
- **DO** keep the surroundings clear to provide clean and adequate air circulation.

