

PROTECTION WITHOUT COMPROMISE



Bard-Parker® Protected Disposable Scalpels

Quality You Expect and the Protection You Deserve

With their high quality and stainless steel blades, Bard-Parker® Protected Disposable Scalpels deliver performance without compromising technique.

- Designed for simple one-handed activation
- Protection before and after use
- Assists your hospital to comply with the EU Directive 2010/32/EU - prevention from sharps injuries

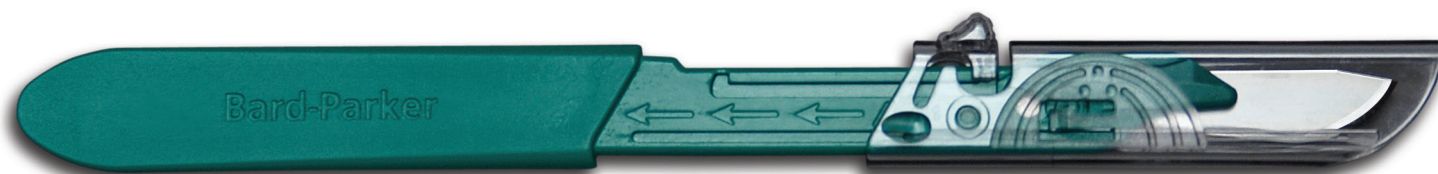

Product Code	Blade Size	Quantity
372610	No.10 Blade	10 Per Box x 10 (100)
372611	No.11 Blade	10 Per Box x 10 (100)
372612	No.12 Blade	10 Per Box x 10 (100)
372613	No.12B Blade	10 Per Box x 10 (100)
372615	No.15 Blade	10 Per Box x 10 (100)
372620	No.20 Blade	10 Per Box x 10 (100)
372621	No.21 Blade	10 Per Box x 10 (100)
372622	No.22 Blade	10 Per Box x 10 (100)
372623	No.23 Blade	10 Per Box x 10 (100)
372710	No.10 Blade with 3L Handle	10 Per Box x 10 (100)
372711	No.11 Blade with 3L Handle	10 Per Box x 10 (100)
372715	No.15 Blade with 3L Handle	10 Per Box x 10 (100)



Available in the following sizes:

10

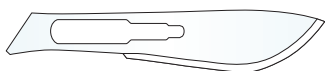

12B

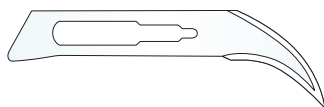

21

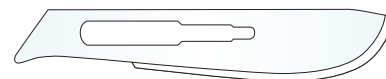

11



15



22

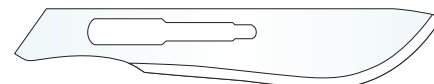

12

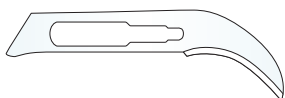

20

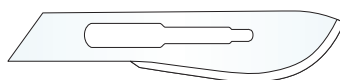

23

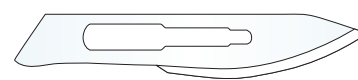

Aspen Medical Europe Ltd, a Hill-Rom Company.

Thornhill Road, North Moons Moat, Redditch, Worcestershire, B98 9NL, UK. Tel: +44 (0)800 0323399 Fax: +44 (0)1527 65100 www.aspenmedicaleurope.com

ASPEN MEDICAL *the brand behind the brands you trust*

Bard-Parker is a registered trademark of Aspen Surgical Products, Inc.

Bard-Parker® Protected Disposable Scalpels

Important Usage Guidelines

Bard-Parker Protected Disposable Scalpels are designed to minimise the risk of surgical blade injuries that occur before use, between steps of the procedure, after use and during disposal. The protective shield is easily activated with one finger by depressing the safety catch to slide the shield to its "In Use" or "Protected" position. The scalpels are virtually the same size and weight as conventional disposable scalpels, and have the same Bard-Parker blade preferred by clinicians.

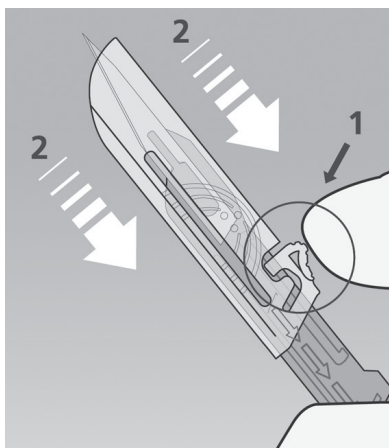

To Use

1. Depress safety catch on the protective shield.
2. Retract shield to rear locked position to fully uncover blade.

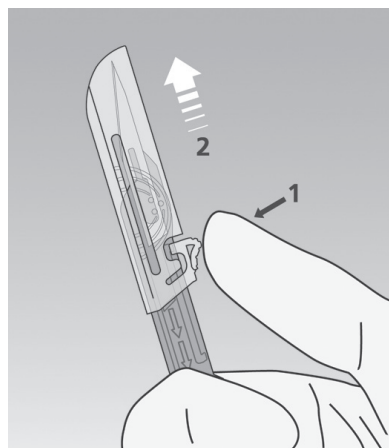

To Cover

1. Depress safety catch on the protective shield.
2. Advance shield to forward locked position at lock indicator line.

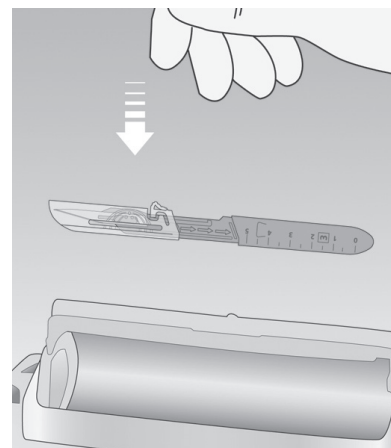

Disposal

Dispose protected scalpel in an approved sharps container in accordance with your facility's sharps disposal procedures.

Protected

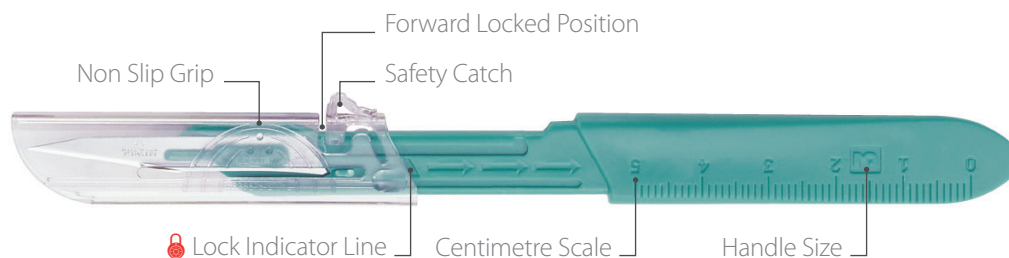

In Use

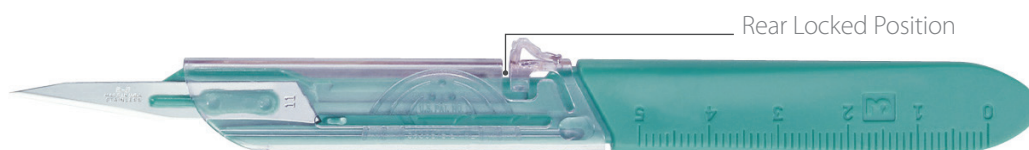

Aspen Medical Europe Ltd, a Hill-Rom Company.

Thornhill Road, North Moons Moat, Redditch, Worcestershire, B98 9NL, UK. Tel: +44 (0)800 0323399 Fax: +44 (0)1527 651100 www.aspenmedicaleurope.com

ASPEN MEDICAL *the brand behind the brands you trust*

Bard-Parker is a registered trademark of Aspen Surgical Products, Inc.